

Crown Click International

CATALOGUE



**SURGICAL
INSTRUMENTS**

CE Compliance Certificate



Application of Medical Device Regulation MDR 2017/ 745 for Class I Medical Devices.

This is to certify that the products submitted are:

MEDICAL DEVICES CLASS I
(Re-Useable Surgical and Dental Instruments)
Registration no DCS/1248322558-A

Manufactured By:

CROWN CLICK INTERNATIONAL

Mehran Street, Mohallah Prem Nagar, Sialkot, 51310 – Pakistan.

Comply with the applicable requirements of the MDR 2017/ 745, The Technical file of the devices have been assessed, including the EC declaration of conformity according to the Annex IV confirming that the medical devices are fulfilling the applicable requirements of MDR 2017/745.

Limitations:

The manufacturer must inform DCS of any substantial changes occurred in the Product or process in order to examine whether this certificate remains valid.

CHAIRMAN

SCHEME MANAGER

Certificate Issue Date: August 08, 2024

Certificate Expiry Date: August 07, 2025

This Certificate of Registration is granted subject to the Regulations approved by the Board

www.dynamexcertification.org



CERTIFICATE



Dynamex Certification Services certify that
CROWN CLICK INTERNATIONAL

Registration No. DCS/2232-B

Address to which this certificate refers:

Mehran Street, Mohallah Prem Nagar, Sialkot, (51310) – Pakistan.

Approved Scope to which this certificate refers:

“Manufacturer and Exporter of Surgical & Dental Instruments”

has been evaluated and found to meet the requirements of

ISO 13485: 2016

CHAIRMAN

SCHEME MANAGER

Certificate Issue Date: 08 August, 2024

Certificate Expiry Date: 07 August, 2025

Date of Initial Registration: 08 August, 2024

Re-assessment Date: 07 August, 2027

This Certificate of Registration is granted subject to the Regulations approved by the Board

www.dynamexcertification.org



CERTIFICATE



Dynamex Certification Services certify that
CROWN CLICK INTERNATIONAL

Registration No. DCS/2232-A

Address to which this certificate refers:

Mehran Street, Mohallah Prem Nagar, Sialkot, (51310) – Pakistan.

Approved Scope to which this certificate refers:

“Manufacturer and Exporter of Surgical & Dental Instruments”

has been evaluated and found to meet the requirements of

ISO 9001: 2015

CHAIRMAN

SCHEME MANAGER

Certificate Issue Date: 08 August, 2024

Certificate Expiry Date: 07 August, 2025

Date of Initial Registration: 08 August, 2024

Re-assessment Date: 07 August, 2027

This Certificate of Registration is granted subject to the Regulations approved by the Board

www.dynamexcertification.org



COMPANY PROFILE

Instrumed (Pvt) Ltd., was established in 1974. The founder of the company Mr. Ejaz Ahmed Chatha (Late) started his career in the family business with his brothers in 1960. This family business was established in 1908.

Instrumed (Pvt) Ltd., produces a vast range of Surgical, Dental & Veterinary Instruments and Scissors. Such as: Diagnostic, Puncture, Anesthesia, General Suture, Bone, Tracheotomy, Goiter, Stomach, Intestine, Rectum, Kidney, Liver, Gall Stone, Gynecology, Obstetrics, Ophthalmic, E.N.T and Micro Surgery Instruments.

Instrumed (Pvt) Ltd., Is introducing new line of instruments such as cardiovascular, Electro-Medical and gynecology laser instruments. We are always trying to improve the quality and reliability of our products.

Instrumed (Pvt) Ltd., Exports their instruments to 30 countries of the world. Our instruments satisfy our clients entirely. Instrumed (Pvt.) Ltd. Is certified under ISO-9002, ISO 13485 and EN-46002 is also approved under GMP regulation and is authorized to mark "CE" on our instruments.

INDEX

- 10** Diagnostic Instruments
- 11** Puncture Instruments
- 12** Anaesthesia Instruments
- 13** General Instruments
- 14** General Instruments
- 15** General Instruments
- 16** General Instruments
- 17** General Instruments
- 18** General Instruments
- 19** Suture Instruments
- 20** Plaster Instruments
- 21** Bone Instruments
- 22** Tracheotomy Instruments
- 23** Goitre Instruments
- 24** Dermatology Instruments
- 25** Stomach, Intestine and Rectum Instruments
- 26** Bladder and Urology Instruments
- 27** Gynecology Instruments
- 28** Obstetrics Instruments
- 29** Cardiovascular Instruments
- 30** Ophthalmology Instruments
- 31** Neuro and Laminectomy Instruments
- 32** Micro Instruments
- 33** Otology Instruments
- 34** Rhinology Instruments
- 35** Oral Instruments
- 36** Tonsil Instruments
- 37** Broncho-Esophagoscopy Instruments
- 38** Sterilizing Instruments
- 39** Asepsis



Aly
10-01000-17
17cm/6¾"



Wartenberg
10-01004-19
19cm/7½"



Weber
10-01008-09
9cm/3½"



wood

Pinard
10-01012-18
18cm/7"



aluminium

Pinard
10-01016-15
15cm/6"



Chest piece only
10-01020-01

Ford
10-01020-00



Chest piece only
10-01024-01

Dual
10-01024-00

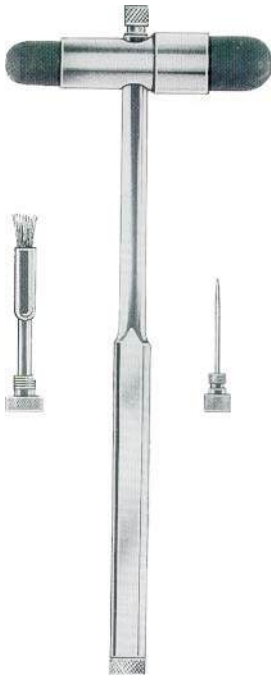

Buck
10-01028-18
18cm/7"



Buck
10-01032-18
18cm/7"



Troemner
10-01036-24
24cm/9½"



Taylor
10-01040-16 16cm/6 ½"
10-01040-18 18cm/7"
10-01040-20 20cm/8"

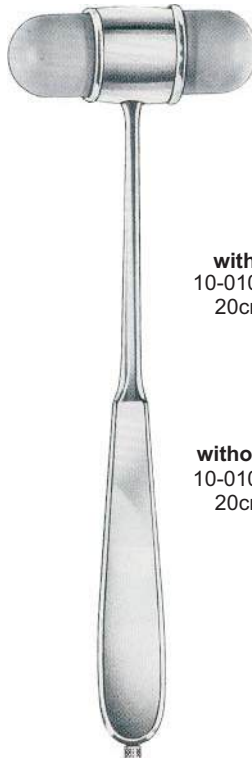

with pin
10-01044-20
20cm/8"

without pin
10-01046-20
20cm/8"

Dejerine
20cm/8"

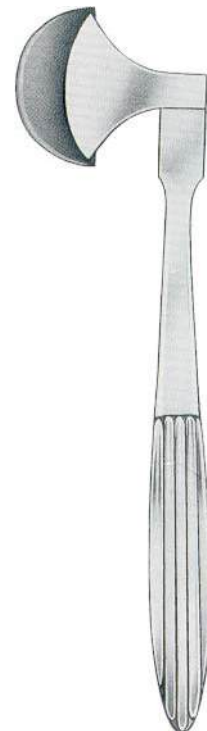

Berliner
10-01050-20
20cm/8"



Traube
10-01054-16
16 cm/6¼"



Troemner
10-01058-21
21 cm/8¼"



Divers-Duoflex
10-01062-22
22 cm/8¾"



Babinsky
10-01066-22 22 cm/8¾"
10-01066-25 25 cm/10"



Rabiner
10-01068-23
23 cm/9¼"



National Hospital
10-01070-33
33 cm/13"



Queen Sqaure
10-01074-26
26 cm/10¼"



10-01078-00



10-01082-00



10-01086-00

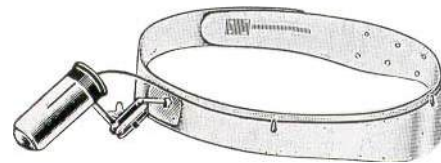

Jansen
10-01092-00

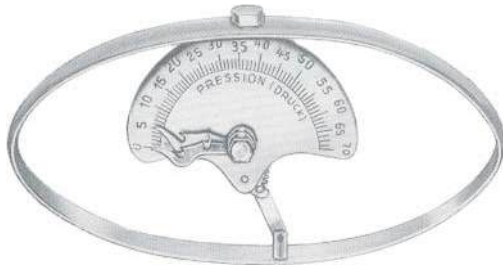

Collin
for children for adults
10-01096-01 10-01096-02

Goniometer

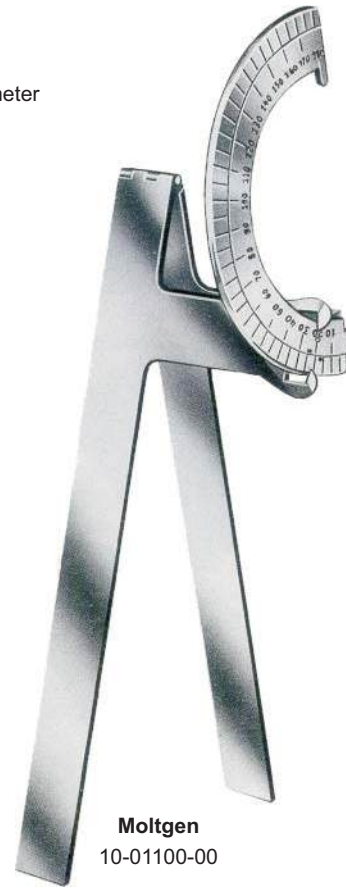

Moltgen
10-01100-00

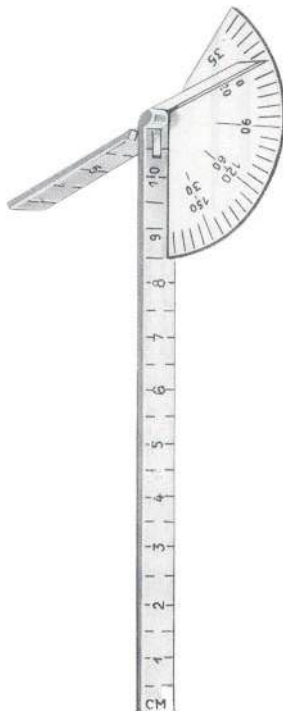

Caroll
10-01104-14
14cm/5½"



Townley
10-01108-10
10cm/4"



Standard (Nelson)

Ømm	11cm/4 1/2"
3.0	11-01112-30
3.5	11-01112-35
4.0	11-01112-40
4.5	11-01112-45
5.0	11-01112-50
5.5	11-01112-55
6.0	11-01112-60



Standard (Nelson)

Ømm	12cm/4 3/4"
3.0	11-01116-30
3.5	11-01116-35
4.0	11-01116-40
4.5	11-01116-45
5.0	11-01116-50
5.5	11-01116-55
6.0	11-01116-60



Standard (Nelson)

Ømm	12cm/4 3/4"
3.0	11-01120-30
3.5	11-01120-35
4.0	11-01120-40
4.5	11-01120-45
5.0	11-01120-50
5.5	11-01120-55
6.0	11-01120-60



Universal

11-01124-03 =3 Set of 3
11-01124-04 =4 Set of 4



Ø6



4 1/2



3



1 3/4 mm



Universal

11-01128-03 =3 Set of 3
11-01128-04 =4 Set of 4

∅ 2 mm



Landau
11-01132-16
16cm/6¼"

∅ 2 mm



Landau
11-01136-19
19cm/7½"

∅ 13.5mm



Peau
11-01140-16
16cm/6¼"

∅ 8 mm



Buelau
11-01144-24
24cm/9½"



Nelson

Ø mm	21cm/8¼"
7.5	11-01148-07
9.0	11-01148-09
10.5	11-01148-10
12.0	11-01148-12

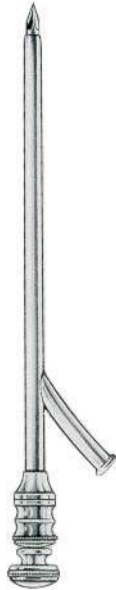

Ochsner

Ø mm	14.5cm/5½"
4.0	11-01152-40
4.6	11-01152-46
5.5	11-01152-55
6.5	11-01152-65

Ø5.5 mm



Krause
 11-01156-15
 15cm/6"



Ø2.25 mm

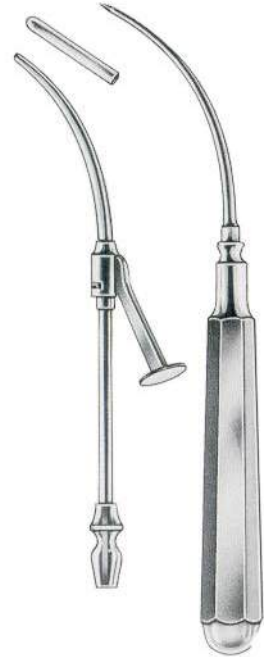

Coakley
 11-01160-16
 16cm/6¼"

Ø1.8 mm



Lichtwitz
 11-01164-19
 19cm/7½"

Ø3 mm



Douglas
 11-01168-11
 11.5 cm/4 ½"



11-01172-11
 11.5 cm/4½"



Pierce

Ø mm	
3.0	11-01176-03
4.0	11-01176-04
5.0	11-01176-05



Frazier

Ømm	Charr./Fr.
2	6 12-01180-06
2 1/3	7 12-01180-07
2 2/3	8 12-01180-08
3	9 12-01180-09
3 1/3	10 12-01180-10
3 2/3	11 12-01180-11
4	12 12-01180-12
5	15 12-01180-15



Ferguson

Ømm	Charr./Fr.
2	6 12-01184-06
2 1/3	7 12-01184-07
2 2/3	8 12-01184-08
3	9 12-01184-09
3 1/3	10 12-01184-10
3 2/3	11 12-01184-11
4	12 12-01184-12

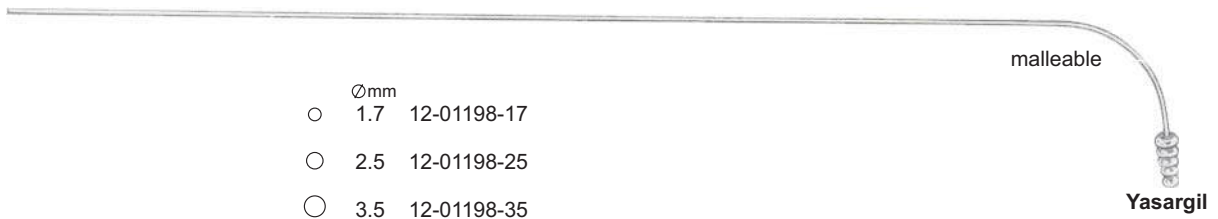
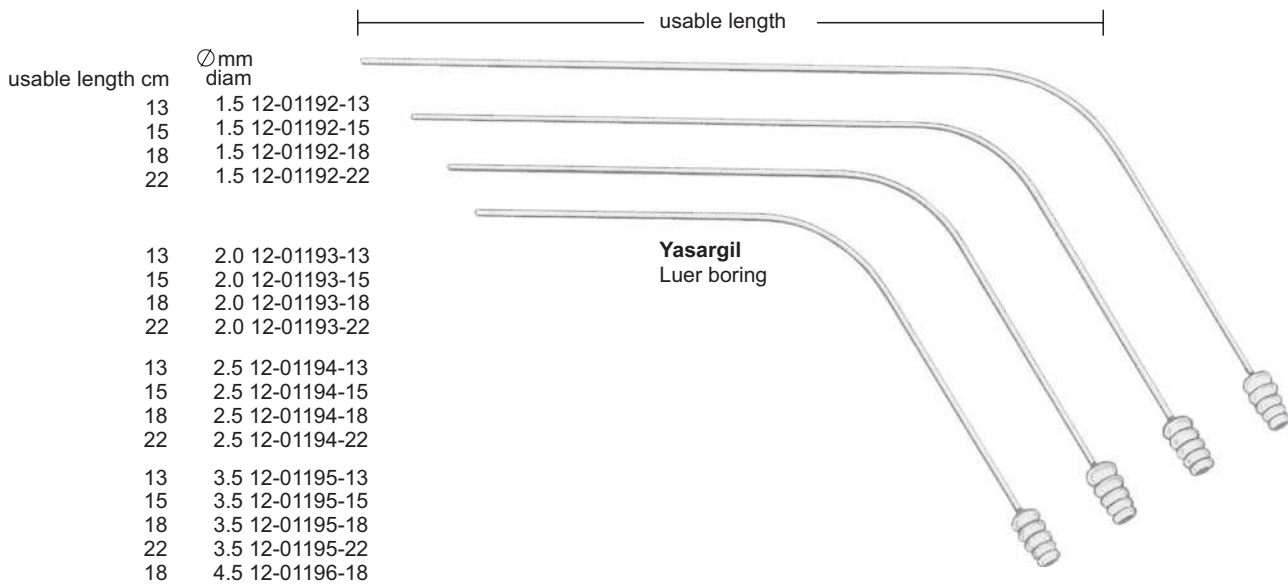

Brain Suction Tubes



∅
2.0 mm 12-01202-20
2.5 mm 12-01202-25
3.0 mm 12-01202-30
13cm/5"

Frazier



∅
1.5 mm 12-01206-15
2.0 mm 12-01206-20
2.5 mm 12-01206-25
3.0 mm 12-01206-30
19.5cm/7¾"

Plester



Adson
12-01210-02
21cm/8¼"
∅4 mm

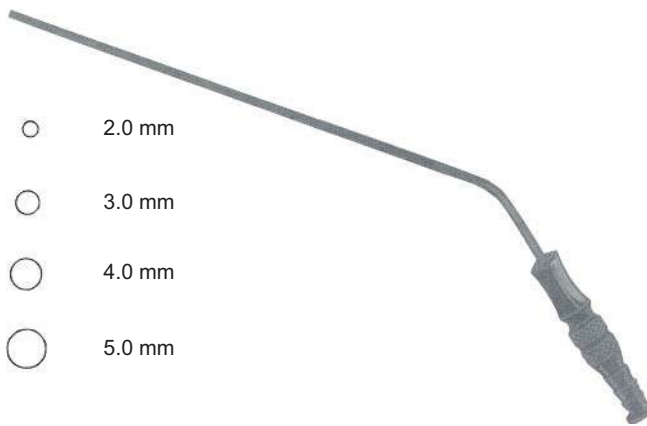

- 2.0 mm
- 3.0 mm
- 4.0 mm
- 5.0 mm

∅ malleable, black
2 mm 12-01214-02
3 mm 12-01214-03
4 mm 12-01214-04
5 mm 12-01214-05
19.5cm/7¾"



Yankauer
12-01218-27
27cm/10½"



with stopcock

Yankauer
12-01219-27
27cm/10½"



Yankauer
12-01220-01



Fig. 0
12-01220-10



Fig. 1
12-01220-11



Fig. 2
12-01220-12



Fig. 3
12-01220-13

12-01220-50 SET

∅ 6 mm
round



Nuboer
12-01224-01
21cm/8¼"

6 mm
ovale



Nuboer
12-01224-02
21cm/8¼"

∅ 6 mm



Andrew-Pynchon
12-01228-23
23 cm/9"



Finsterer
12-01232-30
30cm/12"

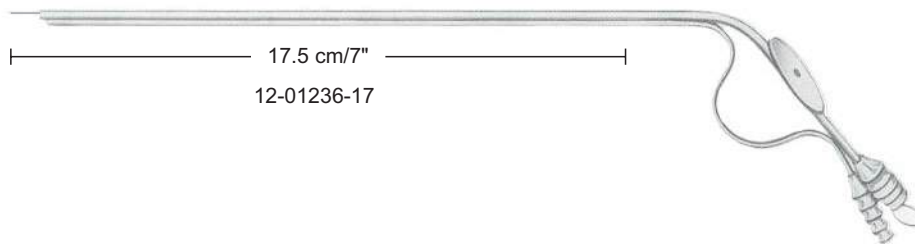

17.5 cm/7"
12-01236-17

Ø 6 mm



Baby-Poole
12-01240-20
20cm/8"

Ø10 mm



Poole
12-01240-22
22cm/8¾"

Ø 8 mm



Poole
12-01244-22
22cm/8¾"



Yankauer
12-01248-34
34.5cm/13 1/4"

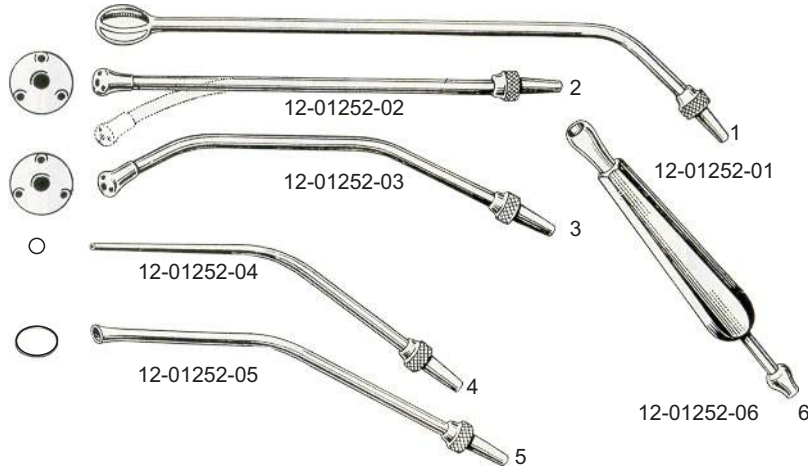

Yankauer universal
Complete Set
12-01252-60

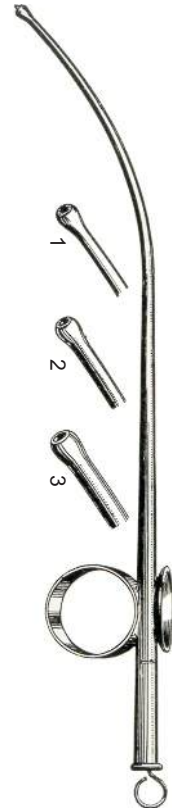

Magill
12-01256-01=20cm/8"
12-01256-02=20cm/8"
12-01256-03=20cm/8"



Millin
12-01262-30
30cm/12"



Simpson-Smith
12-01266-00



Schimmelbusch
12-01272-01 Child
12-01272-02 Adult



Magill
12-01280-15 15 cm/6" Infant
12-01280-20 20 cm/8" Child
12-01280-25 25 cm/10" Adult



Yankauer
12-01276-01 Child
12-01276-02 Adult



Connel
12-01284-01 Child
12-01284-02 Adult



12-01288-01



Lumbard-Mayo
12-01288-02



12-01288-03

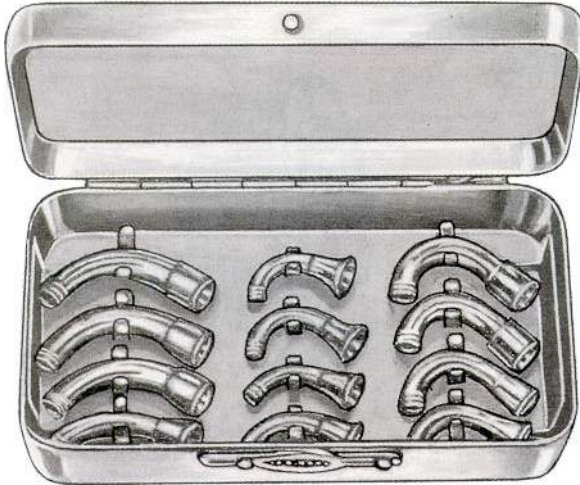

Magill
Connection Set
12-01292-00



Magill (Nasal)

	mm dia
12-01292-01	5.5
12-01292-02	6.5
12-01292-03	7.5
12-01292-04	8.0
12-01292-05	8.5
12-01292-06	9.5
12-01292-07	10.0
12-01292-08	10.5



Magill (Aural)

	mm dia
12-01296-01	5.5
12-01296-02	6.5
12-01296-03	7.5
12-01296-04	8.0
12-01296-05	8.5
12-01296-06	9.5
12-01296-07	10.0
12-01296-08	10.5



Cobb
12-01300-01 Small
12-01300-02 Medium
12-01300-03 Large

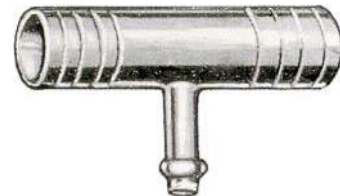

Ayre
12-01304-01 Small
12-01304-02 Medium
12-01304-03 Large

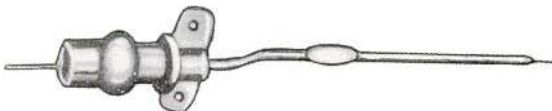

Hamilton Bailey
12-01308-01 Infant
12-01308-02 Child
12-01308-03 Adult

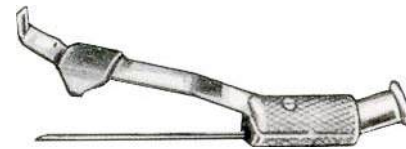

Mitchell
12-01312-18
12-01312-20
38 mm



McIntosh
12-01316-30
12-01316-40

12-01316-30
Laryngoscope Set
Consisting of:
12-01332-00 Battery Handle (without batteries)
12-01316-11 McIntosh blade, Fig 1
12-01316-12 ditto, Fig 2
12-01316-13 ditto, Fig 3



12-01316-10



12-01316-11



12-01316-12



12-01316-13



12-01316-14

12-01316-40
Laryngoscope Set
Consisting of:
12-01332-00 Battery Handle (without batteries)
12-01316-11 McIntosh blade, Fig 1
12-01316-12 McIntosh blade, Fig 2
12-01316-13 McIntosh blade, Fig 3
12-01316-14 McIntosh blade, Fig 4

McIntosh Laryngoscope Blades
12-01316-10 Fig 0, Working length 55mm, baby's
12-01316-11 Fig 1, Working length 75mm, children's
12-01316-12 Fig 2, Working length 90mm, adolescent's
12-01316-13 Fig 3, Working length 110mm, women's
12-01316-14 Fig 4, Working length 135mm, men's



12-01320-30
Laryngoscope Set
Consisting of:
12-01332-00 Battery Handle (without batteries)
12-01320-12 Guedel-Negus Blade, Fig 2
12-01320-13 ditto, Fig 3
12-01320-14 ditto, Fig 4

Guedel-Negus
12-01320-30
12-01320-40

12-01320-40
Laryngoscope Set
Consisting of:
12-01332-00 Battery Handle (without batteries)
12-01320-11 Guedel-Negus Blade, Fig 1
12-01320-12 Guedel-Negus Blade, Fig 2
12-01320-13 Guedel-Negus Blade, Fig 3
12-01320-14 Guedel-Negus Blade, Fig 4



12-01320-11



12-01320-12



12-01320-13



12-01320-14

Guedel Laryngoscope Blades
12-01320-11 Fig 1, working length 70mm, children's
12-01320-12 Fig 2, working length 90mm, adolescent's
12-01320-13 Fig 3, working length 110mm, women's
12-01320-14 Fig 4, working length 135mm, men's



Foregger
12-01324-30
12-01324-40

12-01324-30
Laryngoscope Set
Consisting of:
12-01332-00 Battery Handle (without batteries)
12-01324-12 Foregger Blade, Fig 2
12-01324-13 ditto, Fig 3
12-01324-14 ditto, Fig 4

12-01324-40
Laryngoscope Set
Consisting of:
12-01324-00 Battery Handle (Without batteries)
12-01324-11 Foregger Blade, Fig 1
12-01324-12 Foregger Blade, Fig 2
12-01324-13 Foregger Blade, Fig 3
12-01324-14 Foregger Blade, Fig 4



12-01324-11



12-01324-12



12-01324-13



12-01324-14

Foregger Laryngoscope Blade,
12-01324-11 Fig 1, working length 70mm, children's
12-01324-12 Fig 2, working length 90mm, adolescent's
12-01324-13 Fig 3, working length 110mm, women's
12-01324-14 Fig 4, working length 135mm, men's



Working length 55 mm
12-01328-10

Working length 80 mm
12-01328-11

12-01328-20
Laryngoscope Set, Baby and Infant,
consisting of :
12-01332-00 Battery Handle (without battery)
12-01328-10 Miller-baby blade, Fig 0
working length 55 mm
12-01328-11 ditto, Fig 1 working length 80 mm

Miller-Baby
12-01328-20



32 mm dia
12-01332-00



28 mm dia
12-01336-00



18 mm dia
12-01340-00



Negus
18 mm dia
12-01344-00



No. 3

13-01348-03



No. 3

13-01352-03



No. 4

13-01356-04



No. 4

13-01360-04

double handle
number 3 + number 4



No. 7

13-01364-07



No. 7k

13-01368-17



No. 8

13-01372-08



No.9

13-01376-09



13-01380-34

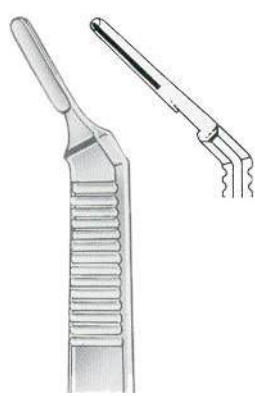

3L
13-01384-13



4L
13-01388-14



No. 3L
13-01392-03



No. 4L
13-01396-04



No. 5
13-01400-05
15cm/6"



No. 5A
13-01404-15
15cm/6"



13-1408-01
21cm/8¼"



13-01408-03



17cm/6¾"



Fig. 1

13-01412-01



Fig. 2

13-01412-02



Fig. 3

13-01412-03



Fig. 4

13-01412-04



Fig. 5

13-01412-05



Fig. 6

13-01412-06



Fig. 7

13-01412-07



Fig. 8

13-01412-08



Fig. 9

13-01412-09



Fig. 10

13-01412-10



Fig. 1
13-01416-01



Fig. 2
13-01416-02



Fig. 3
13-01416-03



Fig. 4
13-01416-04



Fig. 5
13-01416-05



Fig. 6
13-01416-06



Fig. 7
13-01416-07



Fig. 8
13-01416-08



Fig. 9
13-01416-09



17cm/6¾"



Fig. 10
13-01416-10



Fig. 11
13-01416-11



Fig. 12
13-01416-12



Fig. 13
13-01416-13



Fig. 14
13-01416-14



Fig. 15
13-01416-15



Fig. 16
13-01416-16



Fig. 18
13-01416-18



Fig. 27
13-01416-27



Fig. 38
13-01416-38



Fig. 40
13-01416-40



Fig. 46
13-01416-46



Fig. 61
13-01416-61



Fig. 63
13-01416-63



Dieffenbach
17cm/6¾"



Fig. 1
13-01420-01



Fig. 2
13-01420-02



Fig. 3
13-01420-03



Fig. 4
13-01420-04



Fig. 5
13-01420-05



Fig. 6
13-01420-06



Fig. 7
13-01420-07



Fig. 8
13-01420-08



Fig. 9
13-01420-09



Fig. 15
13-01420-15



Fig. 16
13-01420-16



◀ Fig. 1

Bergmann
13-01424-01
14.5cm/5¾"



Fig. 2
13-01424-02



Fig. 3
13-01424-03



Fig. 4
13-01424-04



Dieffenbach
13cm/5¼"



Fig. 1
13-01428-01



Fig. 2
13-01428-02



Fig. 3
13-01428-03



Fig. 4
13-01428-04



Fig. 5
13-01428-05



Fig. 6
13-01428-06



Fig. 7
13-01428-07



Fig. 8
13-01428-08



Fig. 9
13-01428-09



Fig. 10
13-01428-10



Fig. 11
13-01428-11



Fig. 12
13-01428-12



Simon
20cm/8"



Fig. 1
13-01432-01



Fig. 2
13-01432-02



Fig. 3
13-01432-03



Fig. 4
13-01432-04



Ulrich
22.5 cm/9"



Fig. 1
13-01436-01



Fig. 2
13-01436-02



Fig. 3
13-01436-03



Simon
23.5 cm/9 1/4 "



Fig. 1
13-01440-01



Fig. 2
13-01440-02



Fig. 3
13-01440-03



Fig. 4
13-01440-04



13-01444-01
7.5 cm/3"



13-01444-02
8 cm/3 1/4 "



Length of blades				
cm	in			
9.5	3 3/4			13-01464-09
11.0	4 1/2			13-01468-11
12.0	4 3/4		13-01460-12	
13.0	5	13-01448-13		
15.0	6			
16.0	6 1/4	13-01448-16	13-01456-16	
17.0	6 3/4		13-01452-17	
19.0	7 1/2	13-01448-19	13-01456-19	
20.0	8		13-01452-20	
22.0	8 3/4	13-01448-22	13-01456-22	



Langenbeck
13-01472-01
18 cm/7"

13-01472-02

Virchow

Length of blades

8.5 cm/3 1/2"			13-01488-08
11.0 cm/4 1/2"		13-01480-11	13-01484-11
14.0 cm/5 1/2"		13-01480-14	
16.0 cm/6 1/4"	13-01476-16		
17.0 cm/6 3/4"		13-01480-17	
20.0 cm/8"	13-01476-20		
24.0 cm/9 1/2"	13-01476-24		

Autopsy knives
Length of blades
19.5cm/7 3/4"

Length of blades
9.5cm/3 3/4"

Cartilage knives

Wooden handle

Metal handle

Virchow
13-01492-09

13-01496-19

13-01500-01

13-01504-01



Troutman-Chris
13-01508-09
9cm/3 1/2"



Troutman-Chris
13-01509-09
9cm/3 1/2"



13-01512-11
11cm/4 1/2"



Castroviejo
13-01516-13
13cm/5 1/4"



13-01520-18
18cm/7"



Skull Breaker

13-01524-14
14 cm/5½"

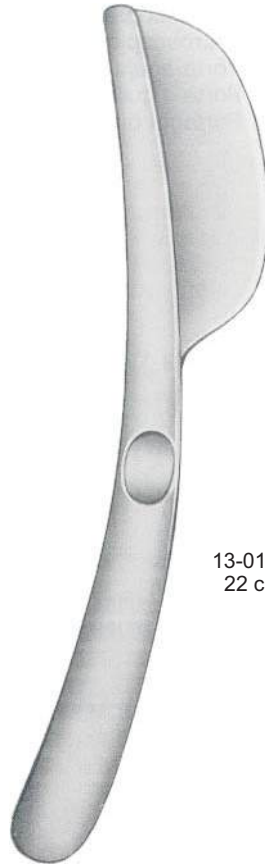

Rachiotome

13-01528-22
22 cm/8¾"



23 mm

Osteotome

13-01532-13
13 cm/5"



Brunetti
13-01536-28
Brunetti
13-01537-28
28.5 cm/11¼"

Muscle hooks



13-01540-06
6.5 cm/2½"



13-01544-07
7 cm/2¾"



13-01548-01

Microscopic needles



13-01552-13
13 cm/5"



13-01556-13
13 cm/5"



Kolle
13-01560-24
24 cm/ 9½"

Microscopic needle holder



Loop for needle holder

13-01564-06
6 cm/2 ¼"

Post mortem needles



13-01568-01

13-01568-02

13-01568-03

13-01568-04

13-01568-05

13-01568-06



13-01572-00

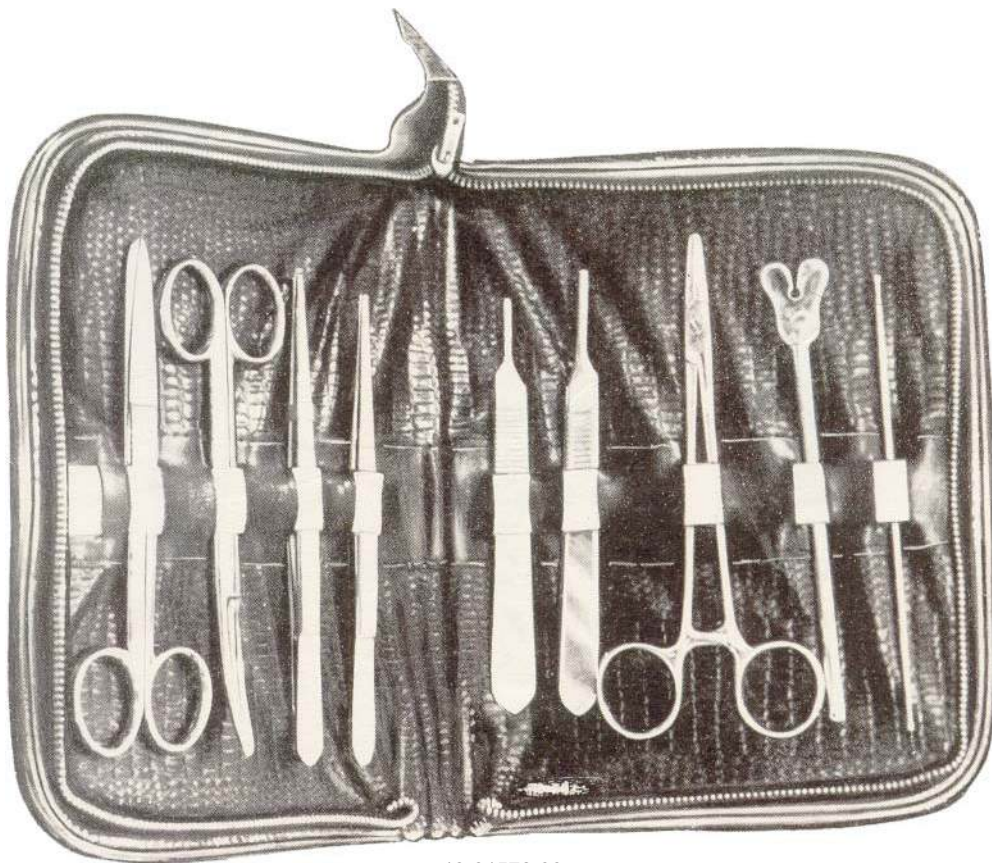

13-01576-00

Saw Edge



Straight	Curved
14-01580-14	14-01581-14
14.5cm/5¾"	



Mayo	
Straight	Curved
14-01584-14	14.5cm/5¾"
14-01584-17	17.0cm/6¾"
14-01584-23	23.0cm/9"
14-01585-14	14-01585-17
14-01585-17	14-01585-23



Mayo-Stille	
Straight	Curved
14-01588-15	15.0cm/6"
14-01588-17	17.0cm/6¾"
14-01589-15	14-01589-17



Lexer	
Straight	Curved
14-01592-16	14-01593-16
16cm/6¼"	



Baby-Metzenbaum	
Straight	Curved
14-01596-11	14-01597-11
11.5cm/4½"	



Metzenbaum-Fine	
Straight	Curved
14-01600-14	14-01601-14
14.5cm/5¾"	



Metzenbaum-Fine	
Straight	Curved
14-01604-18	18cm/7"
14-01604-20	20cm/8"
14-01604-23	23cm/9"
14-01605-18	14-01605-20
14-01605-20	14-01605-23

Saw edge



Sims

Straight	Curved
14-01608-20 20 cm/8"	14-01609-20
14-01608-23 23 cm/9"	14-01609-23



Siebold

14-01613-24
24 cm/9½"



Jameson

16-01617-15 15 cm/6"
16-01617-18 18 cm/7"



Reynolds

Straight	Curved
16-01620-15	16-01621-15
	15 cm/6"



Straight	Curved
14-01624-11	14-01625-11
	11.5 cm/4½"



Straight	Curved
14-01628-11	14-01629-11
	11.5 cm/4½"



Plastic Surgery

Straight	Curved
14-01632-12	14-01633-12
	12 cm/4¾"



Wagner

Straight	Curved
14-01636-12	14-01637-12
	12 cm/4¾"

Saw Edge



14-01641-11
11.5 cm/4½"



14-01645-14
14cm/5½"



Reynolds
14-01649-13
13cm/5"

Endarterectomy
Scissors



Potts-Smith
19cm/7½"



25°
14- 01653-19



45°
14- 01655-19



60°
14- 01657-19

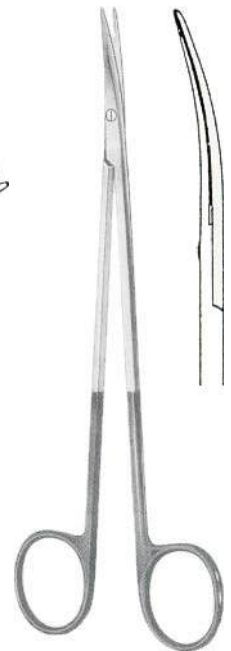

14-01661-17
17cm/6¾"

Saw Edge



Lister
14-01665-14 14.5cm/5¾"
14-01665-18 18cm/7"
14-01665-20 20cm/8"



Braun-Stadler
14-01669-14 14.5cm/5¾"
14-01669-22 22cm/8¾"



Stevens
Straight 14-01672-11 11.5cm/4½"
Curved 14-01673-11



Heymann
14-01677-18
18cm/7"



Fomon
14-01681-13
13cm/5"



Fomon
14-01685-13
13cm/5"



Cottle
14-01689-16
16cm/6¼"



Straight

Standard
Fig. 1

10.0	cm/4"	14-01692-10
11.5	cm/4½"	14-01692-11
13.0	cm/5"	14-01692-13
14.5	cm/5¾"	14-01692-14
15.5	cm/6"	14-01692-15
16.0	cm/6¼"	14-01692-16
18.0	cm/7"	14-01692-18
20.0	cm/8"	14-01692-20



Straight

Standard
Fig. 2

14-01694-10
14-01694-11
14-01694-13
14-01694-14
14-01694-15
14-01694-16
14-01694-18
14-01694-20



Straight

Standard
Fig. 3

14-01696-10
14-01696-11
14-01696-13
14-01696-14
14-01696-15
14-01696-16
14-01696-18
14-01696-20



Straight

Standard
14.5cm/5¾"

PinsmedTC



Fig. 1

14-01700-14



Fig. 2

14-01702-14



Fig. 3

14-01704-14



Curved

Standard
Fig. 1

14-01707-10
14-01707-11
14-01707-13
14-01707-14
14-01707-15
14-01707-16
14-01707-18
14-01707-20



Curved

Standard
Fig. 2

14-01709-10
14-01709-11
14-01709-13
14-01709-14
14-01709-15
14-01709-16
14-01709-18
14-01709-20



Curved

Standard
Fig. 3

14-01711-10
14-01711-11
14-01711-13
14-01711-14
14-01711-15
14-01711-16
14-01711-18
14-01711-20

10.0	cm/4"
11.5	cm/4½"
13.0	cm/5"
14.5	cm/5¾"
15.5	cm/6"
16.0	cm/6¼"
18.0	cm/7"
20.0	cm/8"

PinsmedTC



Curved

Standard
14.5cm/5¾"

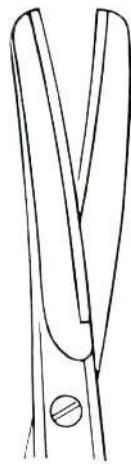

Fig. 1
14-01715-14



Fig. 2
14-01717-14

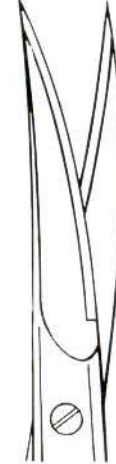

Fig. 3
14-01719-14



Graziil

14-01722-13 13.0 cm/5" 14-01724-13
14-01722-14 14.5 cm/5 3/4" 14-01724-14

Straight



Graziil

14-01727-13 13.0 cm/5" 14-01729-13
14-01727-14 14.5 cm/5 3/4" 14-01729-14

Curved



Straight

14-01732-14

Deaver

14.5cm/5 3/4"



Curved

14-01733-14



Straight

14-01736-15

Mixer

15.5cm/6"



Curved

14-01737-15

Pinsmed TC



Lexer
Straight
14-01740-16
16 cm/6¼"

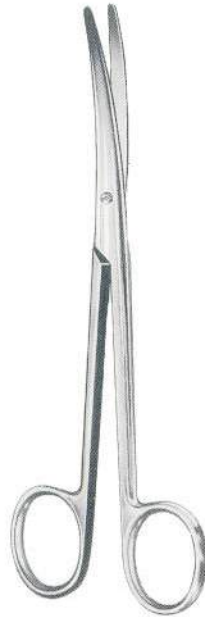

Lexer
Curved
14-01741-16
16 cm/6¼"



Lexer
Straight
14-01744-16
16 cm/6¼"



Lexer
Curved
14-01745-16
16 cm/6¼"

Pinsmed TC



Lexer-Fine
Straight
14-01748-16
16 cm/6¼"



Lexer-Fine
Curved
14-01749-16
16 cm/6¼"



Lexer-Fine
Straight
14-01752-16
16 cm/6¼"



Lexer-Fine
Curved
14-01753-16
16 cm/6¼"

Incision Scissors



14-01756-13 13.0 cm/5¼"
14-01756-14 14.5 cm/5¾"



14-01760-15
15.5 cm/6"



Richter
14-01763-14
14.5 cm/5¾"

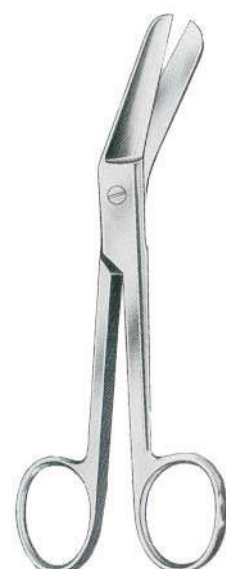

Richter
14-01767-14
14.5 cm/5¾"



Fergusson
14-01771-18
18 cm/7"



New Suture
14-01775-14
14.5 cm/5¾"

Pinsmed TC



Mayo
Straight
14-01778-14 14.5 cm/5¾"
14-01778-15 15.0 cm/6"
14-01778-17 17.0 cm/6¾"
14-01778-19 19.0 cm/7½"
14-01778-23 23.0 cm/9"



Mayo
Curved
14-01779-14 14.5 cm/5¾"
14-01779-15 15.0 cm/6"
14-01779-17 17.0 cm/6¾"
14-01779-19 19.0 cm/7½"
14-01779-23 23.0 cm/9"



Mayo
Straight
14-01782-14 14.5 cm/5¾"
14-01782-17 18.0 cm/7"
14-01782-23 13.0 cm/9"



Mayo
Curved
14-01783-14 14.5 cm/5¾"
14-01783-17 18.0 cm/7"
14-01783-23 13.0 cm/9"

Pinsmed TC



Mayo-Stille
Straight
14-01786-15 15 cm/6"
14-01786-17 17 cm/6¾"
14-01786-19 19 cm/7½"
14-01786-21 21 cm/8¼"



Mayo-Stille
Curved
14-01787-15 15 cm/6"
14-01787-17 17 cm/6¾"
14-01787-19 19 cm/7½"
14-01787-21 21 cm/8¼"

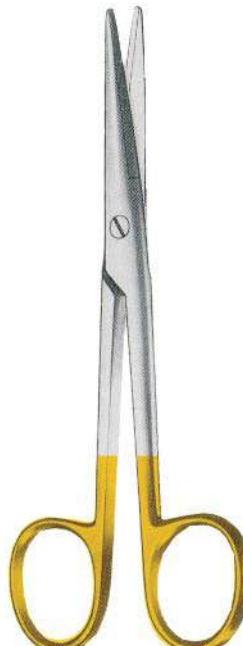

Mayo-Stille
Straight
14-01790-16 15 cm/6"
14-01790-17 17 cm/6¾"

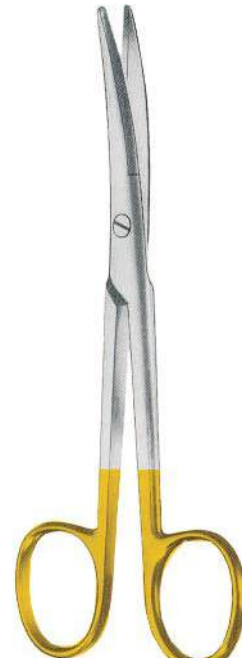

Mayo-Stille
Curved
14-01791-16 15 cm/6"
14-01791-17 17 cm/6¾"



Straight

Mayo-Noble
14-01794-17
17 cm/6¾"



Curved

Mayo-Noble
14-01795-17
17 cm/6¾"



Straight

Baby-Metzenbaum
14-01798-11
11.5 cm/4½"



Curved

Baby-Metzenbaum
14-01799-11
11.5 cm/4½"



Metzenbaum-Fine
14-01802-14
14.5 cm/5¾"

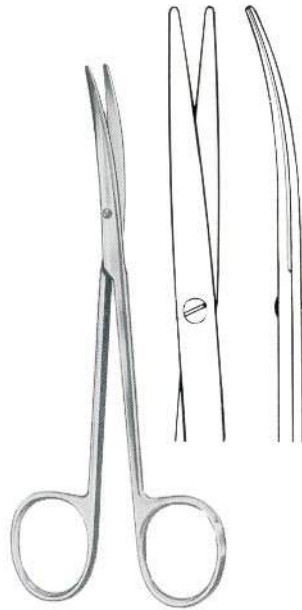

Metzenbaum-Fine
14-01803-14
14.5 cm/5¾"

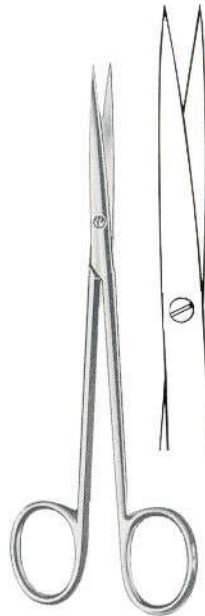

Metzenbaum-Fine
14-01806-14
14.5 cm/5¾"



Metzenbaum-Fine
14-01807-14
14.5 cm/5¾"

Straight

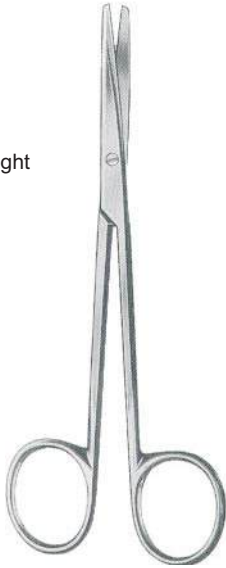

Fig 1

Metzenbaum
14-01810-14
14.5 cm/5¾"



Fig 2

Metzenbaum
14-01812-14
14.5 cm/5¾"

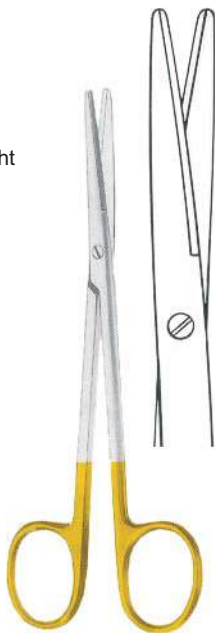

Fig 3

Metzenbaum
14-01814-14
14.5 cm/5¾"

Pinsmed TC

Straight



Metzenbaum
14-01818-14
14.5 cm/5¾"

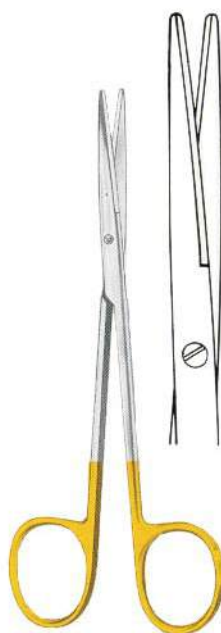

Metzenbaum-Fine
14-01820-14
14.5 cm/5¾"

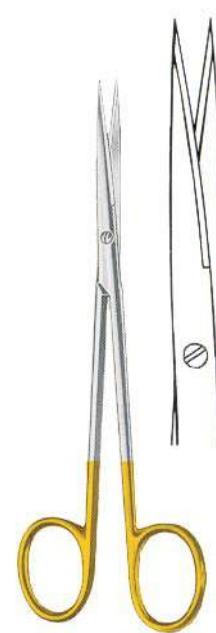

Metzenbaum-Fine
14-01822-14
14.5 cm/5¾"

Curved



Fig. 1
Metzenbaum
14-01825-14
14.5 cm/5¾"



Fig. 2
Metzenbaum
14-01827-14
14.5 cm/5¾"



Fig. 3
Metzenbaum
14-01829-14
14.5 cm/5¾"

Pinsmed TC

Curved

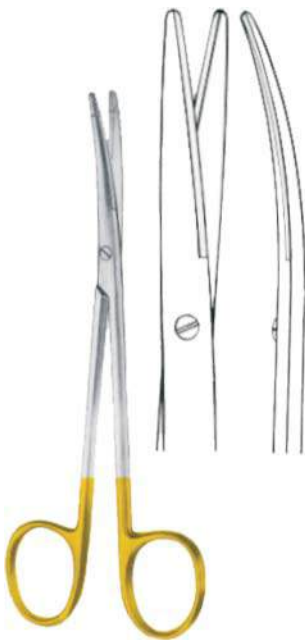

Metzenbaum
14-01831-14
14.5 cm/5¾"



Metzenbaum-Fine
14-01833-14
14.5 cm/5¾"



Metzenbaum-Fine
14-01835-14
14.5 cm/5¾"

Straight



Metzenbaum-Fine

18 cm/7"	14-01838-18
20 cm/8"	14-01838-20
23 cm/9"	14-01838-23
25 cm/10"	14-01838-25
28 cm/11"	14-01838-28
30 cm/12"	14-01838-30



Metzenbaum

14-01840-18
14-01840-20
14-01840-23
14-01840-25
14-01840-28
14-01840-30



Metzenbaum

14-01842-18
14-01842-20
14-01842-23
14-01842-25
14-01842-28
14-01842-30



Metzenbaum

14-01844-18
14-01844-20
14-01844-23
14-01844-25
14-01844-28
14-01844-30

Pinsmed TC

Straight



Metzenbaum

18 cm/7"	14-01848-18
20 cm/8"	14-01848-20
23 cm/9"	14-01848-23
25 cm/10"	14-01848-25
28 cm/11"	14-01848-28
30 cm/12"	14-01848-30



Metzenbaum-Fine

14-01850-18
14-01850-20
14-01850-23
14-01850-25
14-01850-28
14-01850-30



Metzenbaum-Fine

14-01852-18
14-01852-20
14-01852-23
14-01852-25
14-01852-28
14-01852-30

Curved



	Metzenbaum-Fine	Metzenbaum	Metzenbaum	Metzenbaum
18 cm/7"	14-01855-18	14-01857-18	14-01859-18	14-01861-18
20 cm/8"	14-01855-20	14-01857-20	14-01859-20	14-01861-20
23 cm/9"	14-01855-23	14-01857-23	14-01859-23	14-01861-23
25 cm/10"	14-01855-25	14-01857-25	14-01859-25	14-01861-25
28 cm/11"	14-01855-28	14-01857-28	14-01859-28	14-01861-28
30 cm/12"	14-01855-30	14-01857-30	14-01859-30	14-01861-30

Pinsmed TC

Curved



	Metzenbaum	Metzenbaum-Fine	Metzenbaum-Fine
18 cm/7"	14-01865-18	14-01867-18	14-01869-18
20 cm/8"	14-01865-20	14-01867-20	14-01869-20
23 cm/9"	14-01865-23	14-01867-23	14-01869-23
25 cm/10"	14-01865-25	14-01867-25	14-01869-25
28 cm/11"	14-01865-28	14-01867-28	14-01869-28
30 cm/12"	14-01865-30	14-01867-30	14-01869-30



Sims
14-01870-20 20 cm/8"
14-01870-23 23 cm/9"



Straight
14-01872-20 20 cm/8" 14-01874-20
14-01872-23 23 cm/9" 14-01874-23



Sims
14-01977-20 20 cm/8"
14-01977-23 23 cm/9"



Curved
14-01879-20 20 cm/8" 14-01881-20
14-01879-23 23 cm/9" 14-01881-23

Pinsmed TC



Sims
14-01883-20 20 cm/8"
14-01883-23 23 cm/7"



Wertheim
14-01887-14 14.5 cm/5¾"
14-01887-19 19.5 cm/7¾"
14-01887-22 22.5 cm/9"



Curved

Dubois
14-01892-27 27 cm/10½"



Dubois
14-01893-27 27 cm/10½"



Straight

Doyen
14-01896-16 16 cm/6¼"
14-01896-18 18 cm/7"



Curved

Doyen
14-01897-16 16 cm/6¼"
14-01897-18 18 cm/7"



Kelly
14-01900-16 16 cm/6¼"
14-01900-18 18 cm/7"



Kelly
14-01901-16 16 cm/6¼"
14-01901-18 18 cm/7"



Fig. 1
14-01904-12



Fig. 2
14-01906-12

Straight



Fig. 3
14-01908-12

12cm/4¾"



Fig. 1
14-01911-12



Fig. 2
14-01913-12

Curved



Fig. 3
14-01915-12

12cm/4¾"

Saw Edge



Wagner
12cm/4¾"

Curved



Fig. 1
14-01916-12



Fig. 2
14-01918-12



Fig. 3
14-01920-12



Fig. 4
14-01922-12



Fig. 1
14-01923-12



Fig. 2
14-01925-12



Fig. 3
14-01927-12



Fig. 4
14-01929-12



14-01932-12
11.5cm/4½"

Straight



14-01933-12
11.5cm/4½"

Curved



Straight

Brophy (Sullivan)
14-01936-14

14.5 cm/5¾"

14-01937-14



Curved



Straight

Reynolds
14-01940-15
14-01940-18

15 cm/6"
18 cm/7"



Curved

14-01941-15
14-01941-18

Enucleation Scissors



Jameson
14-01945-15
15cm/6"



14-01948-12



14-01951-12



Landolt
12.5cm/5"

14-01953-12



14-01955-12



9.0 cm/3½"	14-01958-09	14-01959-09	14-01961-09	14-01964-09	14-01965-09
10.5 cm/4¼"	14-01958-10	14-01959-10	14-01961-10	14-01964-10	14-01965-10
11.5 cm/4½"	14-01958-11	14-01959-11	14-01961-11	14-01964-11	14-01965-11

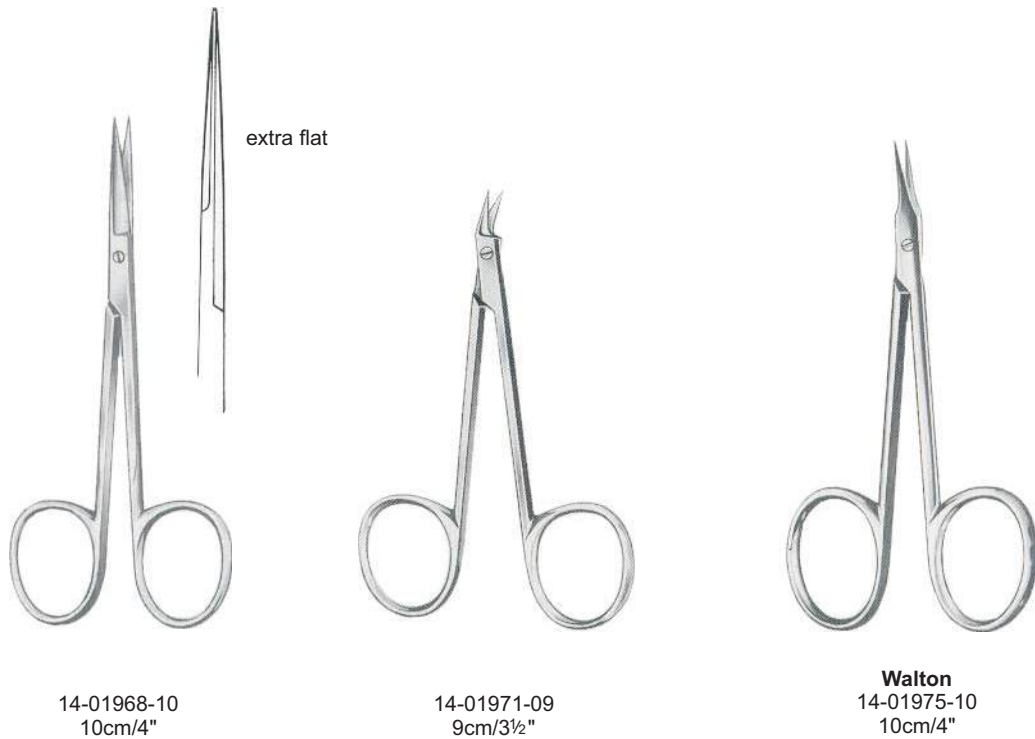

14-01968-10
10cm/4"

14-01971-09
9cm/3½"

Walton
14-01975-10
10cm/4"



Straight

14-01978-14

Sanvenero
14.5cm/5¾"

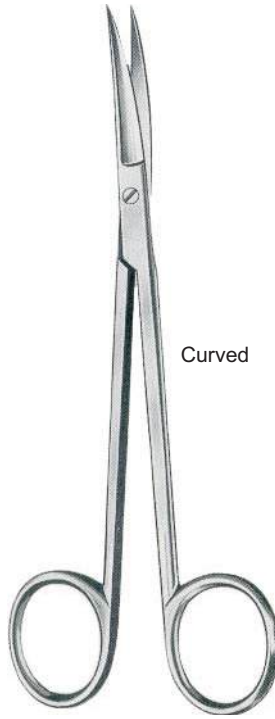

Curved

14-01979-14



Straight

14-01982-10

Baby-Lexer (Knapp)
10cm/4"



Curved

14-01983-10



Straight

14-01986-13

13cm/5"

Curved

14-01987-13



Straight

14-01990-14

Joseph
14cm/5½"



Curved

14-01991-14



Kilner (Regnell)
14-01995-12 12cm/4¾"
14-01995-13 13cm/5"
14-01995-15 15cm/6"



14-01998-14
14.5cm/5¾"

Coronary Scissors



14-02002-11
11.5cm/4½"



Potts-Smith
14-02005-19
19.5cm/7¾"



De Bakey
14-02009-15
15.5cm/6"



De Bakey
14-02013-15
15.5cm/6"



Favaloro
14-02017-15
15cm/6"

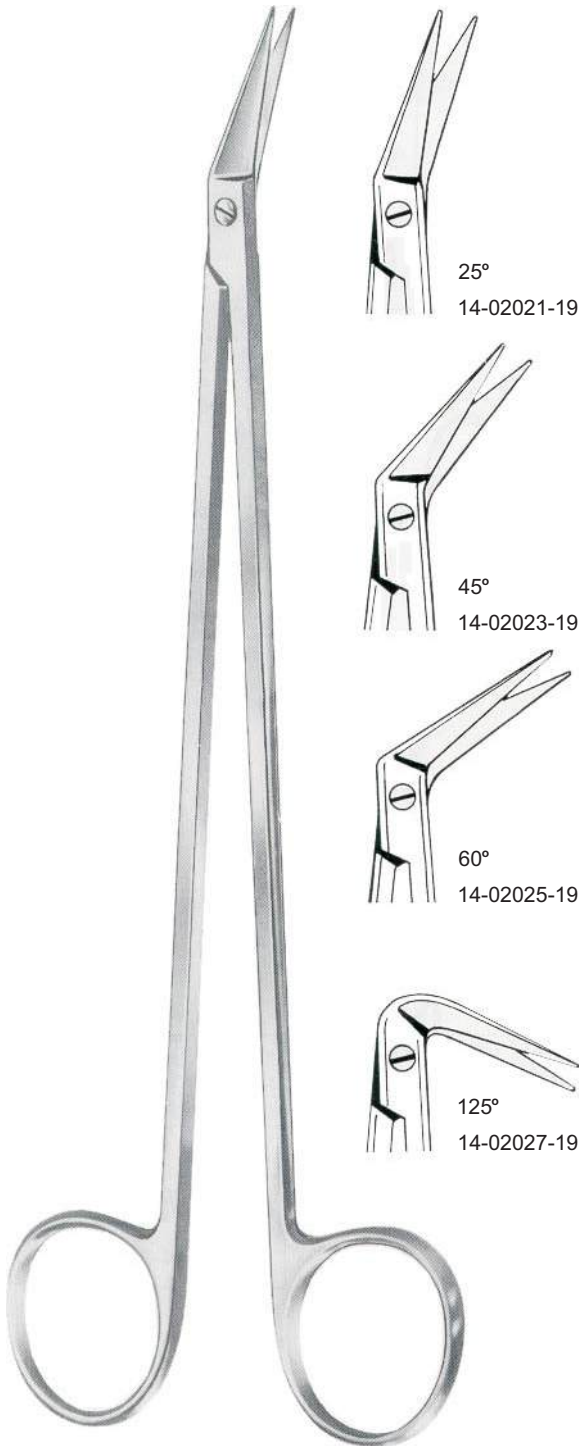

Potts-Smith
19cm/7½"

PinsmedTC

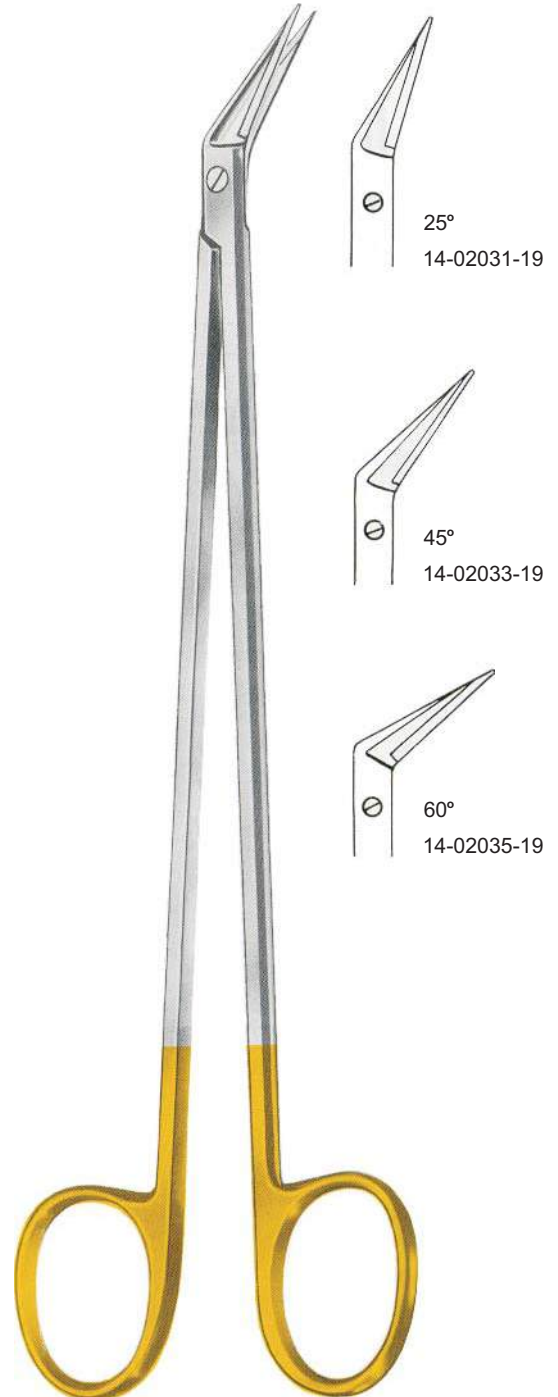

Potts-Smith
19cm/7½"



Saw Edge

Martin-Cartilage
14-02039-20
20cm/8"



McIndoe
14-02042-19
19cm/7½"



Potts-Smith
14-02045-19
19cm/7½"



Satinsky
14-02049-24
24.5cm/10"



Klingenberg-Loth
14-02053-23
23cm/9"



De Bakey
18cm/7"

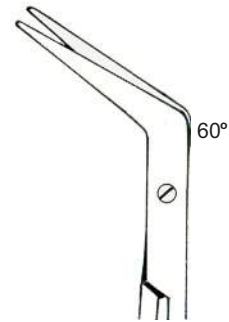
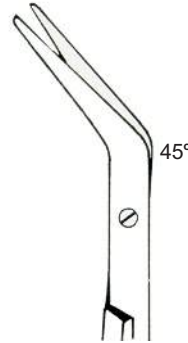
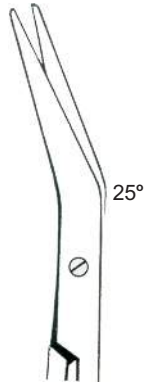

cm	In			
16.0cm	6¼"	14-02057-16	14-02059-16	14-02061-16
23.0cm	9"	14-02057-23	14-02059-23	14-02061-23
28.0cm	11"	14-02057-28	14-02059-28	14-02061-28



Baby-Hegemann
13.5cm/5¼"

Hegemann (Diethrich)
16cm/6¼"
19cm/7½"

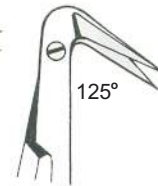

cm	In					
13.0cm	5¼"	14-02063-13	14-02065-13	14-02067-13	14-02069-13	14-02071-13
16.0cm	6¼"	14-02063-16	14-02065-16	14-02067-16	14-02069-16	14-02071-16
19.0cm	7½"	14-02063-19	14-02065-19	14-02067-19	14-02069-19	14-02071-19



Hegemann (Diethrich)
14-02075-19
19cm/7½"



18cm/7"

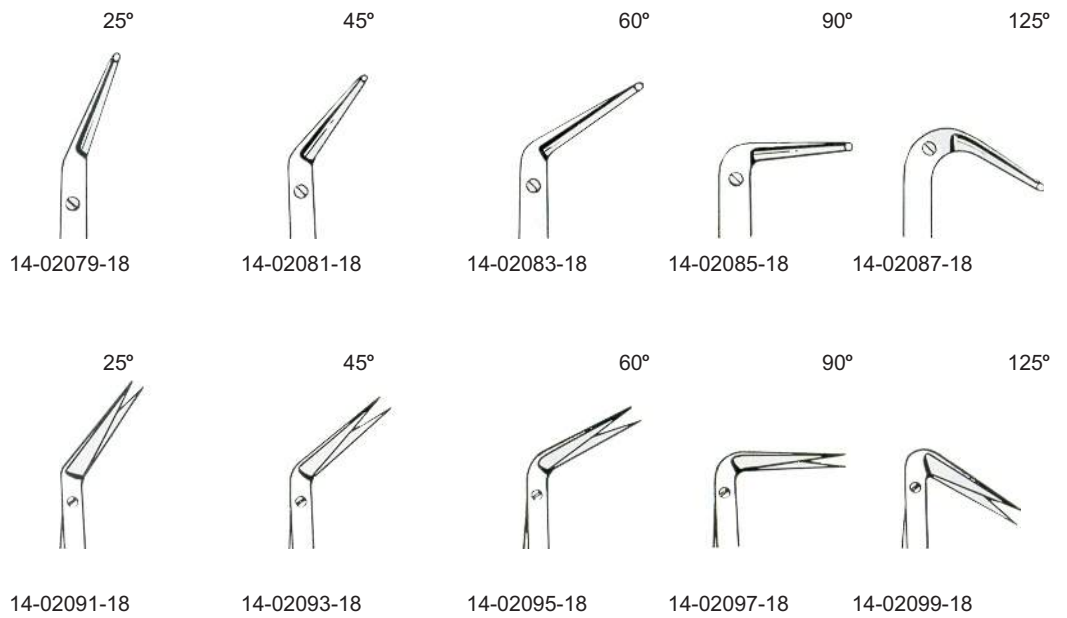

Nerve Dissecting Scissors



14-02103-15
15cm/6"

Tonsil Scissors



Bottcher
14-02107-18
18cm/7"



Prince
14-02111-17
17.5cm/7"

Arteriotomy Scissors



Tonnis-Adson-Fine
14-02115-17
17.5cm/7"

Straight



Tonnis
14-02118-18
18cm/7"

Curved



Tonnis
14-02119-18
18cm/7"



Tonnis-Adson
14-02123-17
17.5cm/7"

PinsmedTC



Tonnis-Adson
14-02125-17
17.5cm/7"

Tonsil Scissors



Good
14-02129-19
19 cm/7½"

Lobectomy Scissors



Crafoord
14-02133-30
30 cm/12"



Finochietto
14-02137-27
27 cm/10½"

Enterotomy Scissors



14-02142-21
21 cm/8¼"



14-02146-21
21 cm/8¼"



14-02150-21
21 cm/8¼"



Busch
14-02153-13 13 cm/5"
14-02153-16 16 cm/6¼"



Schumacher
14-02157-16
16 cm/6¼"



Mod. USA
14-02160-10
10.5 cm/4¼"



Braun-Stadler
14-02163-14
14 cm/5½"



Braun-Stadler
14-02165-22
22 cm/8½"



Pinsmed TC

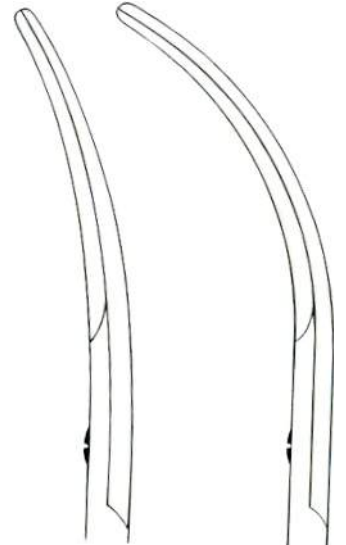

14-02169-23
23 cm/9"

14-02171-23
23 cm/9"



Heymann
14-02175-18
18 cm/7"



Heymann
14-02177-19
19.5 cm/7¾"



Knight
14-02181-18
18 cm/7"



Fomon
14-02185-13
13 cm/5"



Fomon
14-02189-13
13.5 cm/5¼"



Fomon
14-02191-13
13.5 cm/5¼"



Cottle
14-02195-16
16 cm/6¼"



Halle
14-02199-19
19 cm/7¼"



Strully
14-02202-22 22 cm/8¾" 14-02203-22



Dandy
14-02207-22 17 cm/6¾"



Trigeminal Scissors

Olivecrona
14-02211-15



Universal
14-02215-12 12 cm/4¾"



Goldman-Fox
Straight
14-02218-13 13 cm/5"



Goldman-Fox
Curved
14-02219-13 13 cm/5"

Pinsmed TC

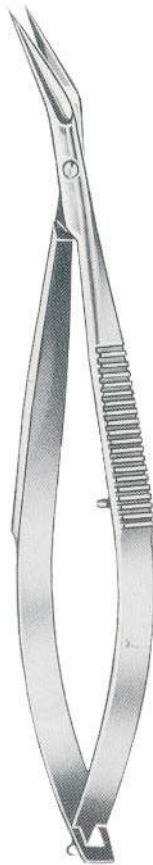

Fig. 1

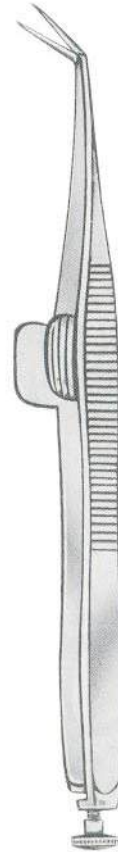

Fig. 2

Fig. 3



Noyes
14-02225-12
12 cm/4¾"



14-02229-01



14-02229-02

Wecker
11.5 cm/4½"

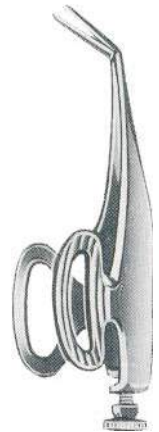

Barraquer
14-02233-05
5.5 cm/2¼"

Noyes
Fig.1 14-02222-01
Fig.2 14-02222-02
Fig.3 14-02222-03
12 cm/4¾"

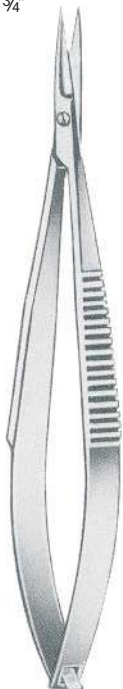

14-02236-09
9 cm/3½"



14-02238-09



14-02240-09



14-02243-09



14-02245-09



14-02247-09

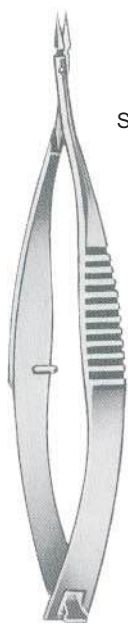

Straight

Vannas
14-02250-08
8 cm/3¼"

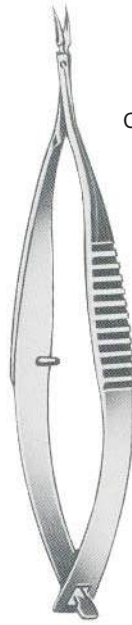

Curved

Vannas
14-02253-08
8 cm/3¼"

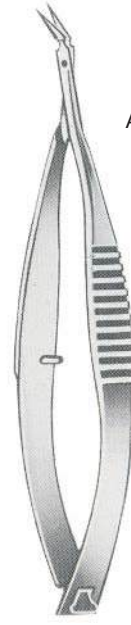

Angular

Vannas
14-02255-08
8 cm/3¼"

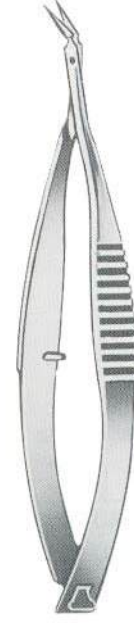

Vannas
14-02257-08
8 cm/3¼"

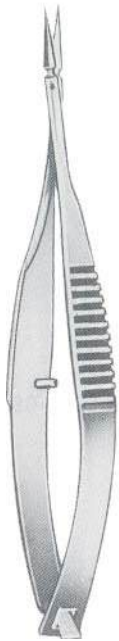

Straight

14-02260-08
8.5 cm/3¼"

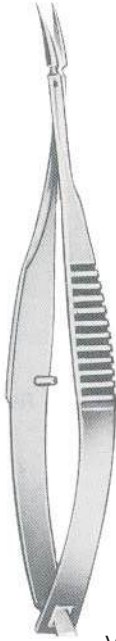

Curved

Vannas Mod, Tubingen
14-02263-08
8.5 cm/3½"

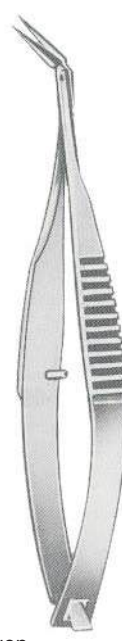

Angular

14-02265-08
8.5 cm/3½"

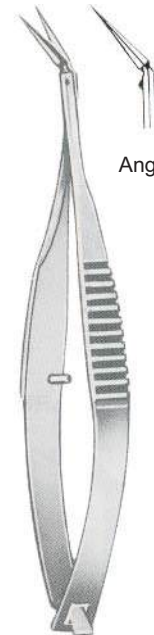

Angular

14-02267-08
8.5 cm/3½"



14-02270-10
10 cm/4"



14-02271-10
10 cm/4"

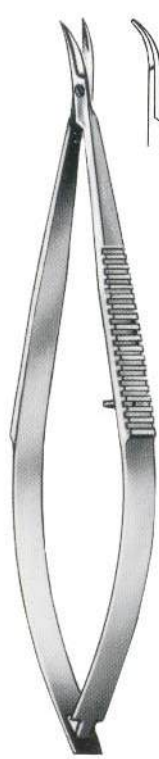

Castroviejo
14-02273-10
10 cm/4"



Castroviejo
14-02275-10
10 cm/4"



Aebli
14-02277-10
10 cm/4"

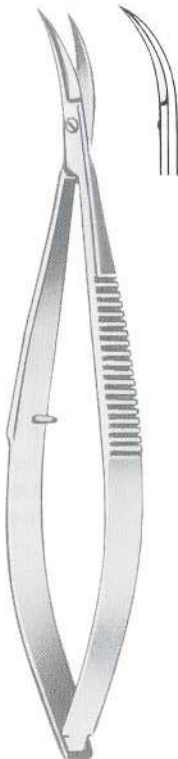

Castroviejo
14-02281-10
10 cm/4"



Castroviejo
14-02283-10
10 cm/4"

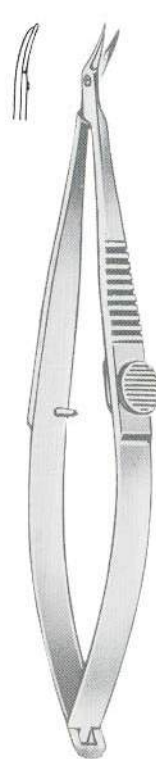

Troutman-Barraquer
14-02285-10
10 cm/4"

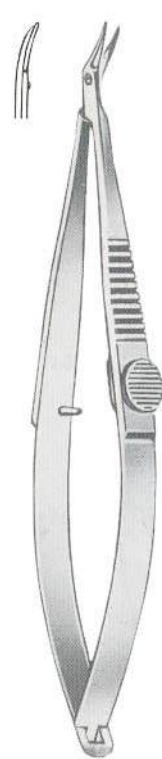

Troutman-Barraquer
14-02287-10
10 cm/4"

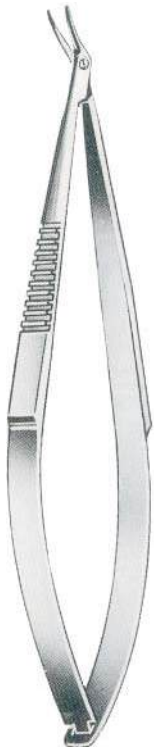

Troutman
14-02291-10
10 cm/4"

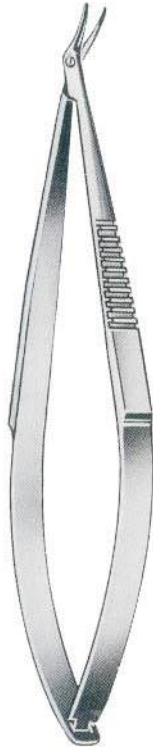

Troutman
14-02293-10
10 cm/4"

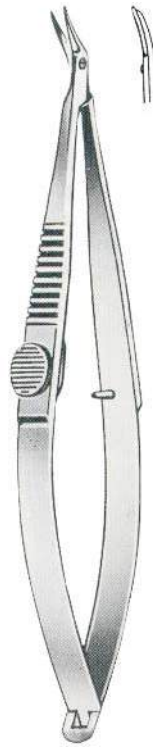

Katzin-Barraquer
14-02295-10
10 cm/4"

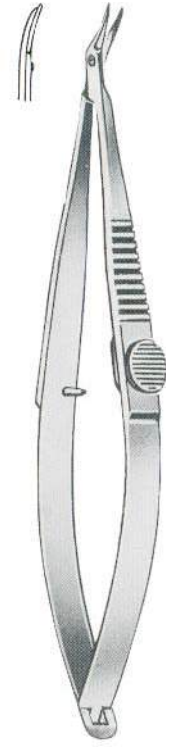

Katzin-Barraquer
14-02297-10
10 cm/4"

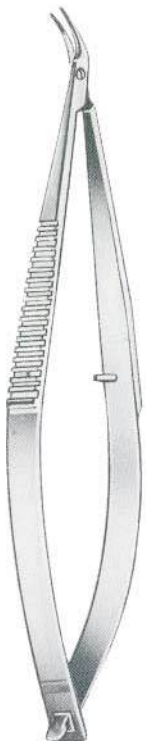

Katzin
14-02301-11
10 cm/4"

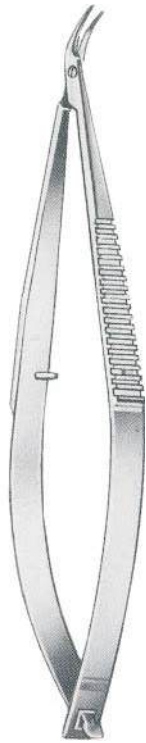

Katzin
14-02303-11
10 cm/4"



Westcott
14-02307-11
11 cm/4 1/2"



Westcott
14-02309-11
11 cm/4 1/2"



Westcott
14-02311-11
11 cm/4 1/2"

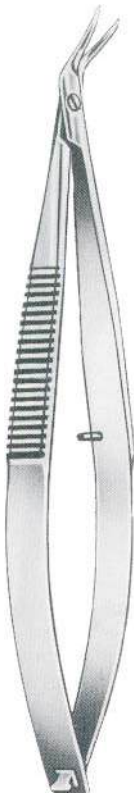

Castroviejo
14-02315-10
10 cm/4"

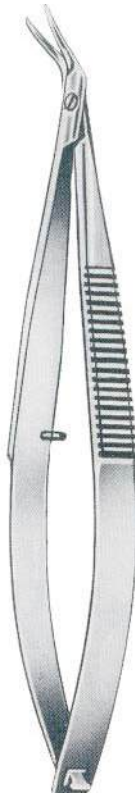

Castroviejo
14-02317-10
10 cm/4"

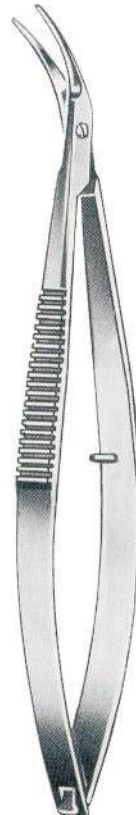

Castroviejo
14-02321-11
11.5 cm/4½"

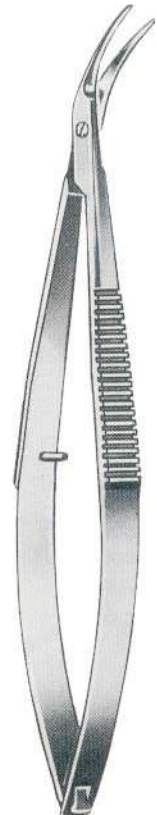

Castroviejo
14-02323-11
11.5 cm/4½"

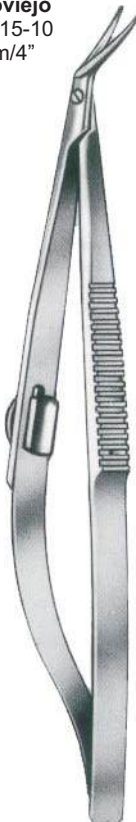

Troutmann-Castroviejo
14-02327-10
10.5 cm/4¼"



Troutmann-Castroviejo
14-02329-10
10.5 cm/4¼"



Straight
14-02332-14
14-02332-18

Curved
14-02333-14
14-02333-18

14.5 cm/5¾"
18.0 cm/7"

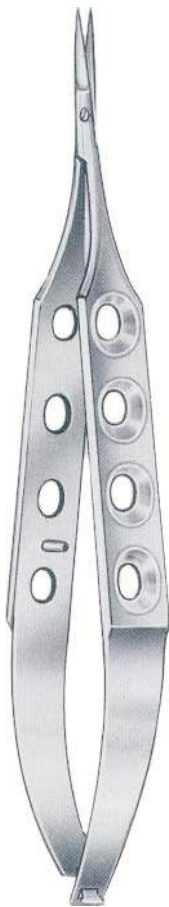

Straight

- 14-02336-12 12.0 cm/4 3/4"
- 14-02336-16 16.0 cm/6 1/4"
- 14-02336-18 18.5 cm/7 1/4"



Curved

- 14-02337-12 12.0 cm/4 3/4"
- 14-02337-16 16.0 cm/6 1/4"
- 14-02337-18 18.5 cm/7 1/4"



**Vannas
Straight**

- 14-02340-12 12.0 cm/4 3/4"
- 14-02340-16 16.0 cm/6 1/4"



**Vannas
Curved**

- 14-02341-12 12.0 cm/4 3/4"
- 14-02341-16 16.0 cm/6 1/4"

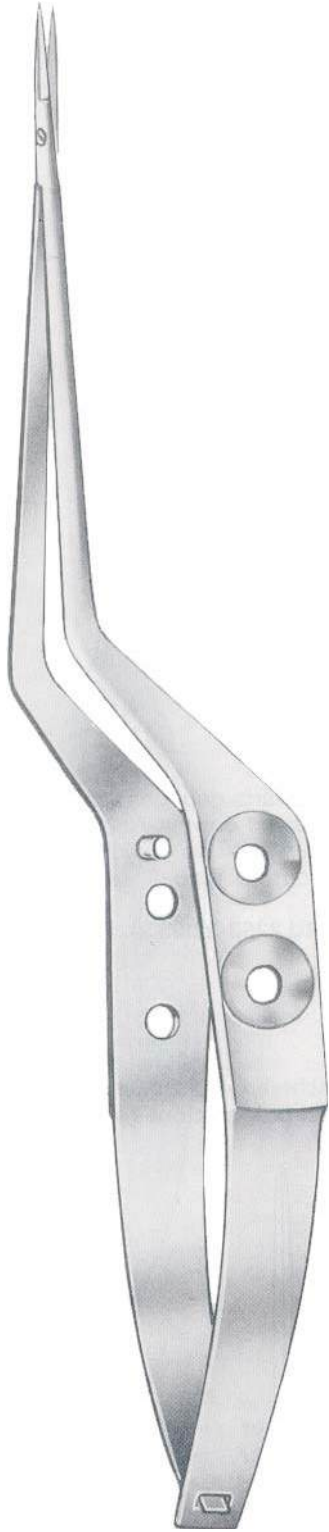

Yasargil

16.5cm/6½"
20.0cm/8"

20.0cm/8"

20.0cm/8"



Straight
14-02344-16
14-02344-20



Curved
14-02345-16
14-02345-20



Curved Downwards
14-02347-20

Dissecting Scissors



Straight
14-02350-20



Curved
14-02351-20



Yasargil

22.5cm/9"
24.5cm/9¾"



Straight
14-02354-22
14-02354-24



Curved
14-02355-22
14-02355-24



Curved Downwards
14-02357-22

22.5cm/9"

Dissecting Scissors



Straight
14-02360-22



Curved
14-02361-22

22.5cm/9"



Jacobson
18cm/7"

14-02364-18



14-02370-19

14-02365-18



14-02371-19

14-02367-18



14-02373-19



14-02376-19



14-02377-19



19cm/7½"

Vein Scissors

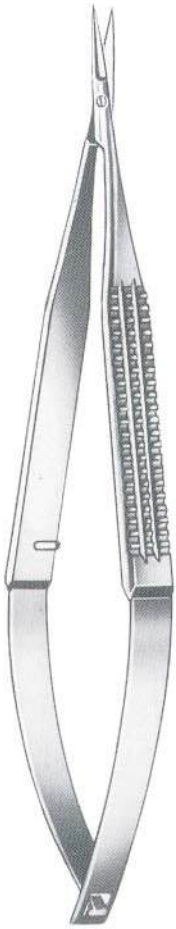

Straight
14-02384-12
12cm/4¾"

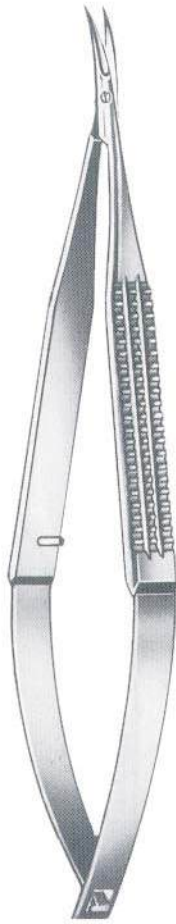

Curved
14-02385-12
12cm/4¾"



Straight
14-02392-12
12cm/4¾"



Curved
14-02393-12
12cm/4¾"

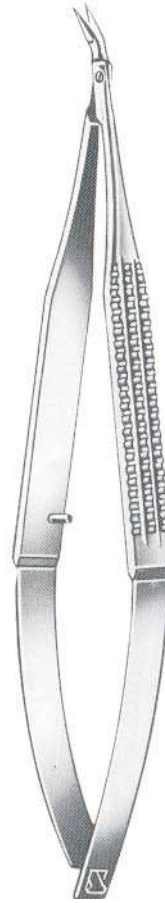

Angled up
14-02395-12
12cm/4¾"



Straight
14-02400-13
13cm/5 1/8"

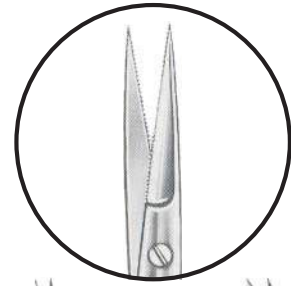

Saw Edge

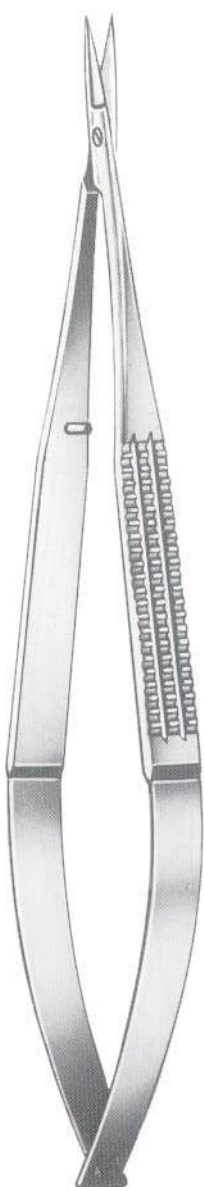

Straight
14-02404-16
16cm/6¼"

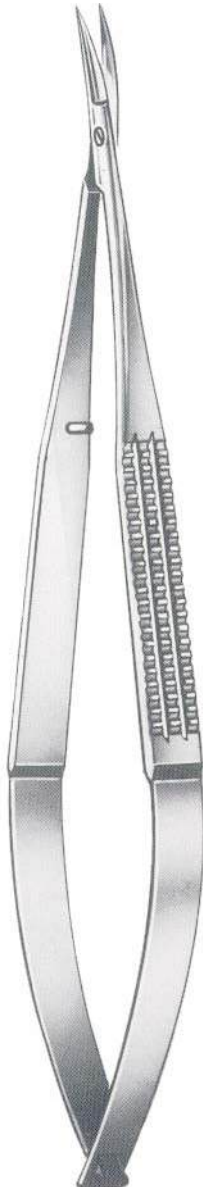

Curved
14-02405-16
16cm/6¼"



Straight
14-02408-16
16cm/6¼"

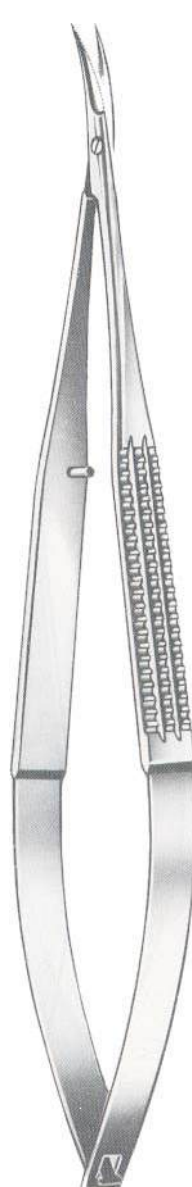

Curved
14-02409-16
16cm/6¼"



Millesi
Straight
14-02412-16
16cm/6¼"



Millesi
Curved
14-02413-16
16cm/6¼"



Straight
14-02416-18
18.5cm/7¼"

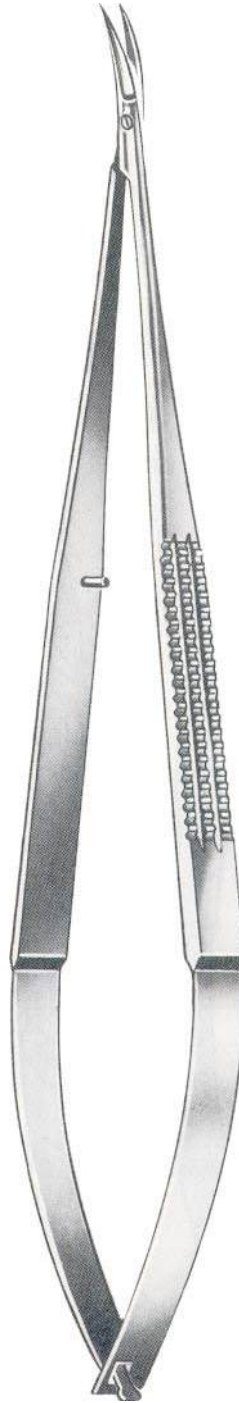

Curved
14-02417-18
18.5cm/7¼"



Angular
14-02421-18
18.5cm/7¼"

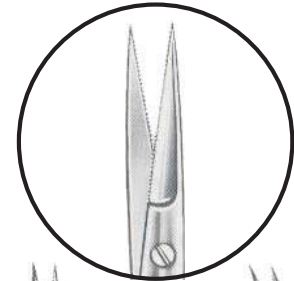

Saw Edge



Straight
14-02424-16
16cm/6¼"



Curved
14-02425-16
16cm/6¼"



Straight
14-02428-16
16cm/6¼"



Curved
14-02429-16
16cm/6¼"



Straight
14-02432-16
16cm/6¼"



Curved
14-02433-16
16cm/6¼"



Straight
14-02436-18
18.5cm/7¼"



Curved
14-02437-18
18.5cm/7¼"



Angular
14-02441-18
18.5cm/7¼"



Straight
14-02444-23
23cm/9"

Dissecting Scissors



Straight
14-02448-14
14.5cm/5¾"



Curved
14-02449-14
14.5cm/5¾"



Curved
14-02451-14
14.5cm/5¾"



PinsmedTC





Standard

9.0 cm/3½"	14-02482-09	14-02483-09	14-02485-09	14-02487-09
10.5 cm/4¼"	14-02482-10	14-02483-10	14-02485-10	14-02487-10
11.5 cm/4½"	14-02482-11	14-02483-11	14-02485-11	14-02487-11



Fine

Fine

9.0cm/3¾"			14-02496-09	14-02497-09
10.5cm/4¼"	14-02492-10	14-02493-10	14-02496-10	14-02497-10
11.5cm/4½"	14-02492-11	14-02493-11	14-02496-11	14-02497-11



Straight

Fine

9.5 cm/3¾"	14-02500-09
10.5 cm/4¼"	14-02500-10
11.5 cm/4½"	14-02500-11



Curved

Fine

14-02501-09
14-02501-10
14-02501-11



Straight

14-02504-10 10cm/4"

Curved

14-02505-10

Tenotomy Scissors



10.5cm/4¼"
11.5cm/4½"



Pointed

Straight
14-02508-10
14-02508-11



Curved
14-02509-10
14-02509-11



Blunt

Straight
14-02512-10
14-02512-11



Curved
14-02513-10
14-02513-11



Straight
14-02516-08



Bonn
8cm/3¼"

Curved
14-02517-08



Graefe
14-02520-10
10.5cm/4¼"



Wilmer
14-02521-10
10cm/4"



14-02524-11



11.5cm/4½" 14-02525-11

PinsmedTC



Straight
14-02528-11



Curved
14-02529-11
11.5cm/4½"



La Grange
14-02532-11
11.5cm/4½"



Chadwick
14-02533-11
11cm/4½"

Neurosurgical Scissors



Straight

14-02536-11 11cm/4½"
14-02536-13 13cm/5"



Curved

14-02537-11
14-02537-13



Potts-de Martel
14-02541-21
21cm/8¼"



Mills
14-02543-21
21cm/8¼"



Dura Scissors

Schmieden-Taylor
14-02547-14 14.5cm/5¾"
14-02547-17 17.0cm/6¾"



14-02551-22
Strully
22cm/8¾"



14-02553-22



Dandy
14-02555-17
17cm/6¾"



Littauer
14-02559-14
14cm/5½"



Spencer
14-02563-09
9cm/3½"



Spencer
14-02565-10 10.5cm/4¼"
14-02565-12 12.0cm/4¾"



Spencer-Fine
14-02567-11 11.5cm/4½"
14-02567-16 16cm/6¼"



Shortbent
14-02571-09
9cm/3½"



Northbent
14-02575-12
12.5cm/5"



Spencer
14-02579-11
11.5cm/4½"



Littler
14-02583-11
11.5cm/4½"



Heath
14-02587-15
15cm/6"



14-02591-10
10cm/4"



Eiselsberg
14-02595-11
11.5cm/4½"



Wire Cutting Scissors

Schoemaker-Loth
14-02599-12
12.5cm/5"



Saw Edge

Universal
14-02603-12
12cm/4¾"

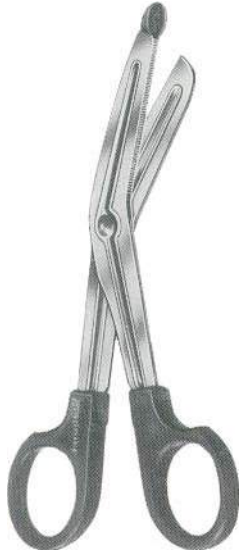

	Universal	Universal	Universal
Black	14-02607-01	14-02609-01	14-02611-01
Blue	14-02607-02	14-02609-02	14-02611-02
Red	14-02607-03	14-02609-03	14-02611-03
Green	14-02607-04	14-02609-04	14-02611-04

14.5 cm/5¾"

16 cm/6¼"

18 cm/7"



Smith
14-02615-17
17.5 cm/7"



Harvey
14-02618-12
12.5 cm/5"

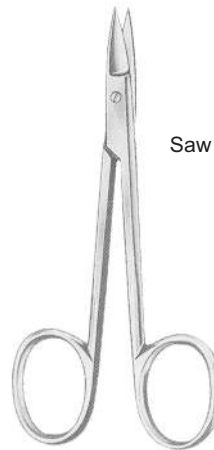

Schuknecht
14-02622-10
10 cm/4"

Nail Splinting Scissors



14-02626-13 13 cm/5"
14-02626-15 15 cm/6"

PinsmedTC



Lister

- 14-02629-09 09.0 cm/3 1/2"
- 14-02629-11 11.5 cm/4 1/2"
- 14-02629-14 14.0 cm/5 1/2"
- 14-02629-15 15.5 cm/6"
- 14-02629-18 18.0 cm/7"
- 14-02629-20 20.0 cm/8"



Lister

- 14-02631-18
18 cm/7"



Lister

- 14-02633-18 18.5 cm/7 1/4"
- 14-02633-21 21.0 cm/8 1/4"



Lister-Excentric

- 14-02637-16 16 cm/6 1/4"
- 14-02637-19 19 cm/7 1/2"



Esmarch

- 14-02641-20 20 cm/8"
- 14-02641-22 22 cm/8 3/4"



Bergmann

- 14-02645-23
23 cm/9"



Lorenz

- 14-02649-23
23 cm/9"



Saw edge

14-02653-17
17 cm/6¾"



Lange
14-02657-18
18 cm/7"



Bruns
14-02661-24 24 cm/9½" Saw edge
14-02663-24 24 cm/9½" Smooth
14-02667-24 24 cm/9½" *Pinsmed TC*

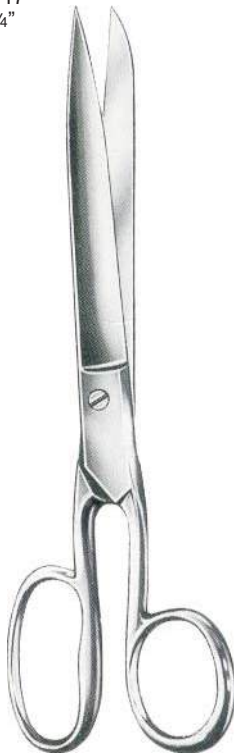

Smith (Mod. USA)
14-02671-18 18 cm/7"
14-02671-20 20 cm/8"
14-02671-23 23 cm/9"



Knowles
14-02674-14
14 cm/5½"



Knowles
14-02675-14
14 cm/5½"



14-02679-13
13 cm/5"



14-02683-20
20 cm/8"



Seutin
14-02687-23
23 cm/9"



14-2691-23
23 cm/9"



Collin
14-02695-22
22 cm/8¾"



Gluck
14-02699-22
22 cm/8¾"



Stille
14-02701-21
21 cm/8¼"



Stille
14-02703-24
24 cm/9½"



Stille
14-02705-23 23 cm/9"
14-02705-26 26 cm/10¼"
14-02705-37 37 cm/14½"

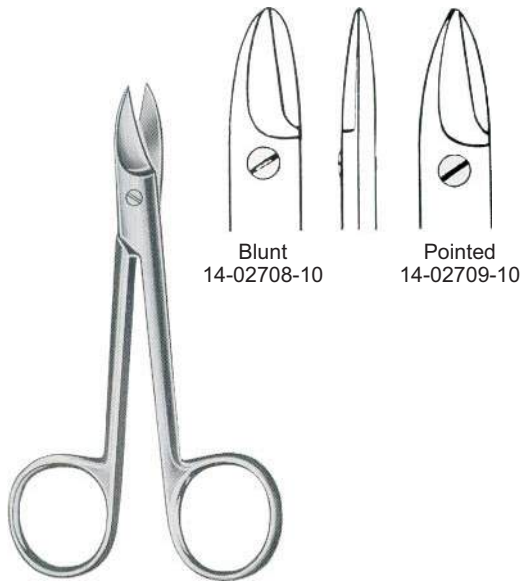

Blunt
14-02708-10

Pointed
14-02709-10

Beebee
Straight
10.5 cm/4 1/4"



Blunt
14-02712-10

Pointed
14-02713-10

Beebee
Curved
10.5 cm/4 1/4"



14-02716-10
10.5 cm/4 1/4"



Beebee
12 cm/4 3/4"

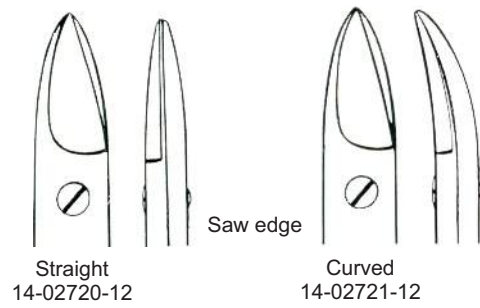

Saw edge
Straight
14-02720-12

Curved
14-02721-12



Goldmann-Fox
14-02724-13
13 cm/5"

Saw edge



Goldmann-Fox
14-02725-13
13 cm/5"



Niro
14-02729-14
14 cm/5 1/2"



Goldmann-Fox
(Spezial)
14-02733-13
13 cm/5"

Saw edge



14-02737-11
11.5 cm/4 1/2"

Fine



Quinby
14-02740-12
12 cm/4 3/4"



Quinby
14-02741-12
12 cm/4 3/4"



Saw edge

Dean
14-02745-17
17 cm/6¾"



Dean
14-02747-17
17 cm/6¾"



Saw edge

Locklin
14-02751-16
16.5 cm/6½"



Locklin
14-02753-16
16.5 cm/6½"



Saw edge

Sullivan
14-02758-14
14.5 cm/5¾"



Sullivan
14-02759-14
14.5 cm/5¾"



Neumann
14-02763-12
12.5 cm/5"



Saw edge

La Grange
14-02765-11
11.5 cm/4½"



14-02768-11	Standard 11.5 cm/4½"	14-02769-11		14-02772-11	Standard 11.5 cm/4½"	14-02773-11		14-02777-11	Chadwick 11.5 cm/4½"
-------------	--------------------------------	-------------	--	-------------	--------------------------------	-------------	--	-------------	--------------------------------

Saw edge

Nail scissors



09.0 cm/3½"	14-02780-09	14-02781-09	14-02784-09	14-02785-09
10.5 cm/4¼"	14-02780-10	14-02781-10	14-02784-10	14-02785-10

Straight

Curved

Straight

Curved

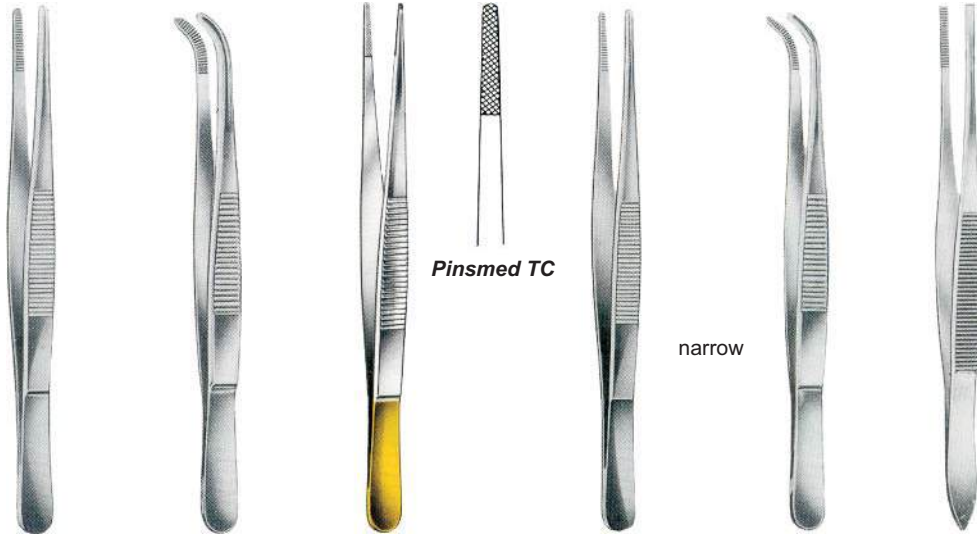

cm	in	Standard	Standard	Standard			Stille
10.5	4 1/4"	15-02788-10					
11.5	4 1/2"	15-02788-11	15-02789-11			15-02796-11	15-02797-11
13.0	5"	15-02788-13	15-02789-13			15-02796-13	15-02797-13
14.5	5 3/4"	15-02788-14	15-02789-14	15-02792-14		15-02796-14	15-02797-14
15.0	6"	15-02788-15					15-02802-15
16.0	6 1/4"	15-02788-16	15-02789-16	15-02792-16		15-02796-16	15-02797-16
17.0	6 3/4"						15-02802-17
18.0	7"	15-02788-18	15-02789-18	15-02792-18		15-02796-18	15-02797-18
20.0	8"	15-02788-20	15-02789-20	15-02792-20		15-02796-20	15-02797-20
25.0	10"	15-02788-25	15-02789-25	15-02792-25		15-02796-25	15-02797-25
30.0	12"	15-02788-30	15-02789-30			15-02796-30	15-02797-30

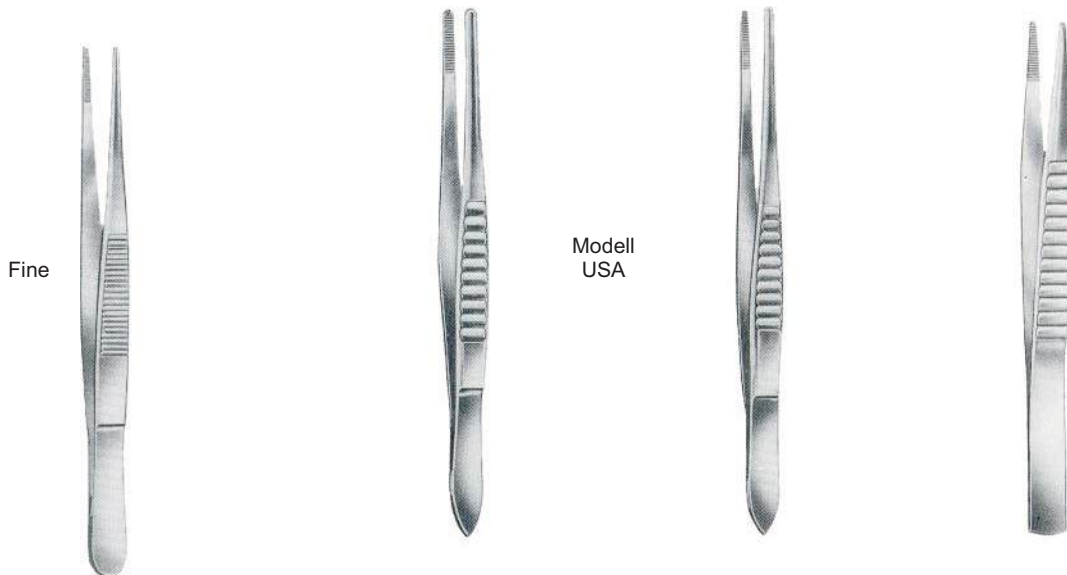

cm	in	Standard	Narrow	Engl.Modell
11.5	4 1/2"	15-02806-11		
12.0	4 3/4"		15-02810-12	15-02814-12
13.0	5"	15-02806-13	15-02810-13	15-02814-13
14.5	5 3/4"	15-02806-14	15-02810-14	15-02814-14
15.0	6"	15-02806-15	15-02810-15	15-02814-15
16.0	6 1/4"	15-02806-16		
18.0	7"	15-02806-18		
20.0	8"	15-02806-20		
21.0	8 1/4"		15-02810-21	
25.0	10"		15-02810-25	
30.0	12"		15-02810-30	

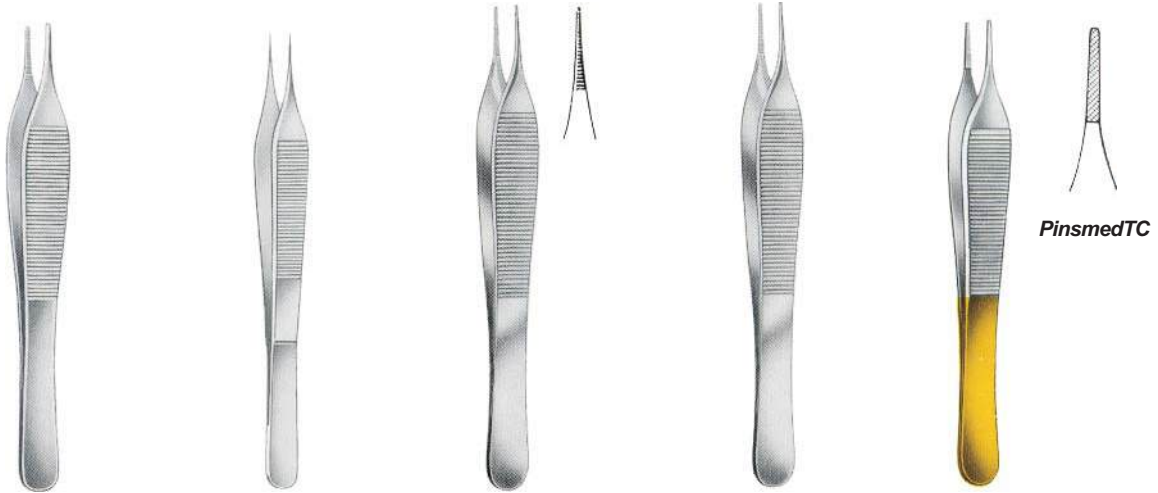

cm	in	Ewald	Jacobson-Adson	Micro-Adson	Adson-Standard	Adson
12.0	4¾"	15-02822-12	15-02826-12	15-02830-12	15-02834-12	15-02838-12
15.5	6"	15-02822-15	15-02826-15	15-02830-15	15-02834-15	15-02838-15

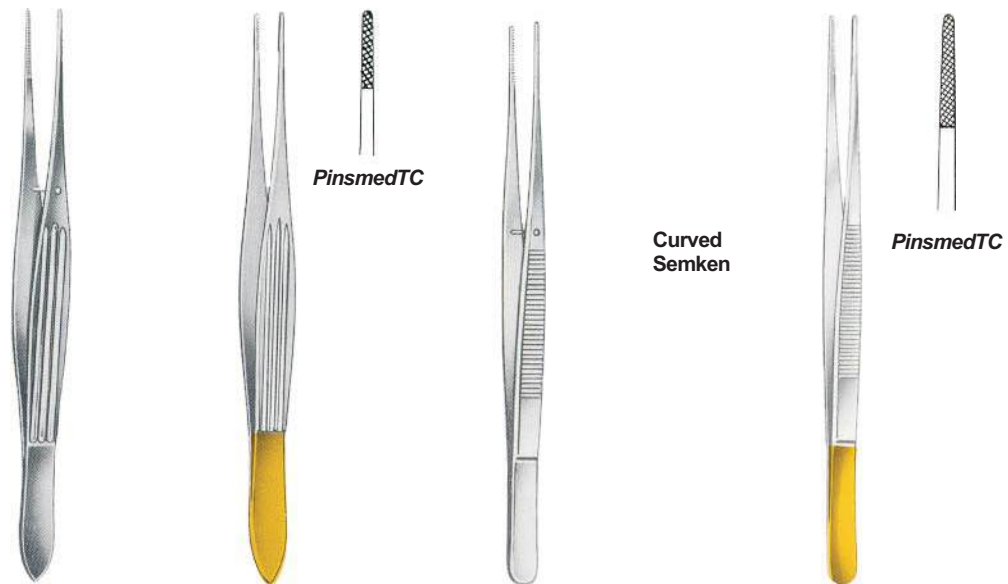

cm	in	McIndoe	McIndoe	Semken	Semken	Semken
12.0	4¾"			15-02848-12	15-02849-12	15-02852-12
15.0	6"	15-02842-15	15-02844-15	15-02848-15	15-02849-15	15-02852-15



Taylor

15-02856-17 15-02857-17 15-02862-17 15-02863-17 15-02867-17

17.5cm/7"



Smooth Jaw

cm	in	Waugh	Bonney	Brophy	Brophy
15.0	6"	15-02870-15			
18.0	7"	15-02870-18	15-02882-18		
20.0	8"	15-02870-20		15-02886-18	15-02887-18

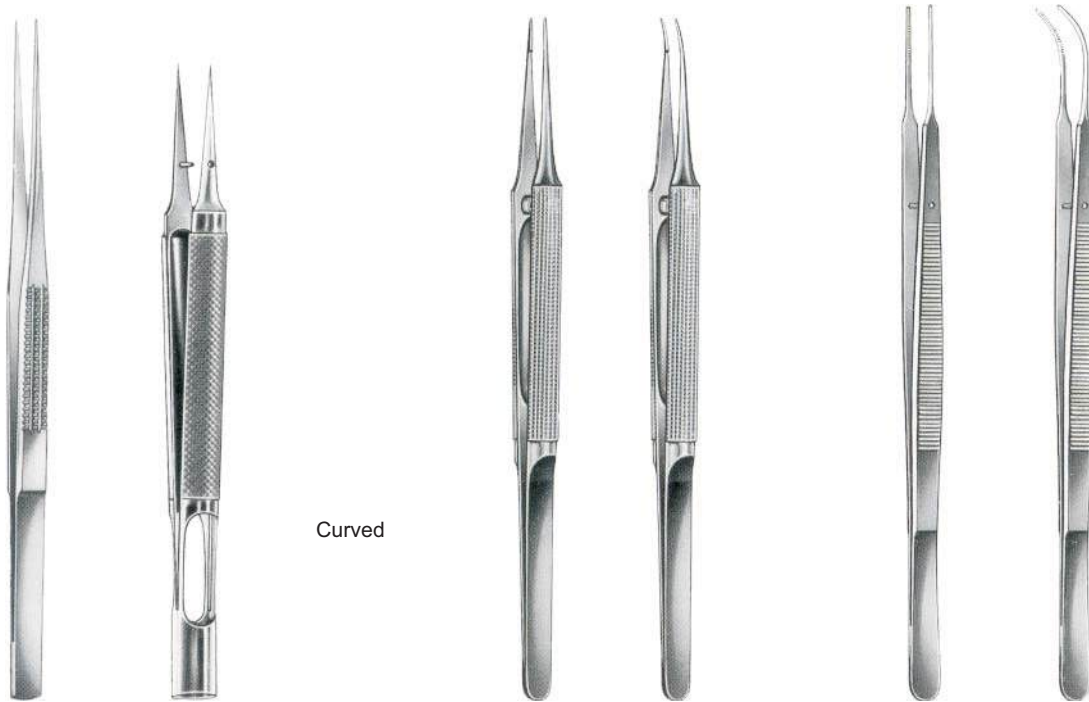

Curved

Gerald

cm	in						
12.0	4¾"			15-02898-12	15-02899-12		
13.0	5"	15-02894-13	15-02895-13				
15.0	6"	15-02890-15		15-02898-15	15-02899-15		
17.5	7"					15-02902-17	15-02903-17
18.0	7"	15-02890-18		15-02898-18	15-02899-18		

Micro Tubal Forceps



Austin
15-02906-14
14cm/5½"

Austin
15-02908-18
18cm/7"

Neubuser
15-02912-20
20cm/8"

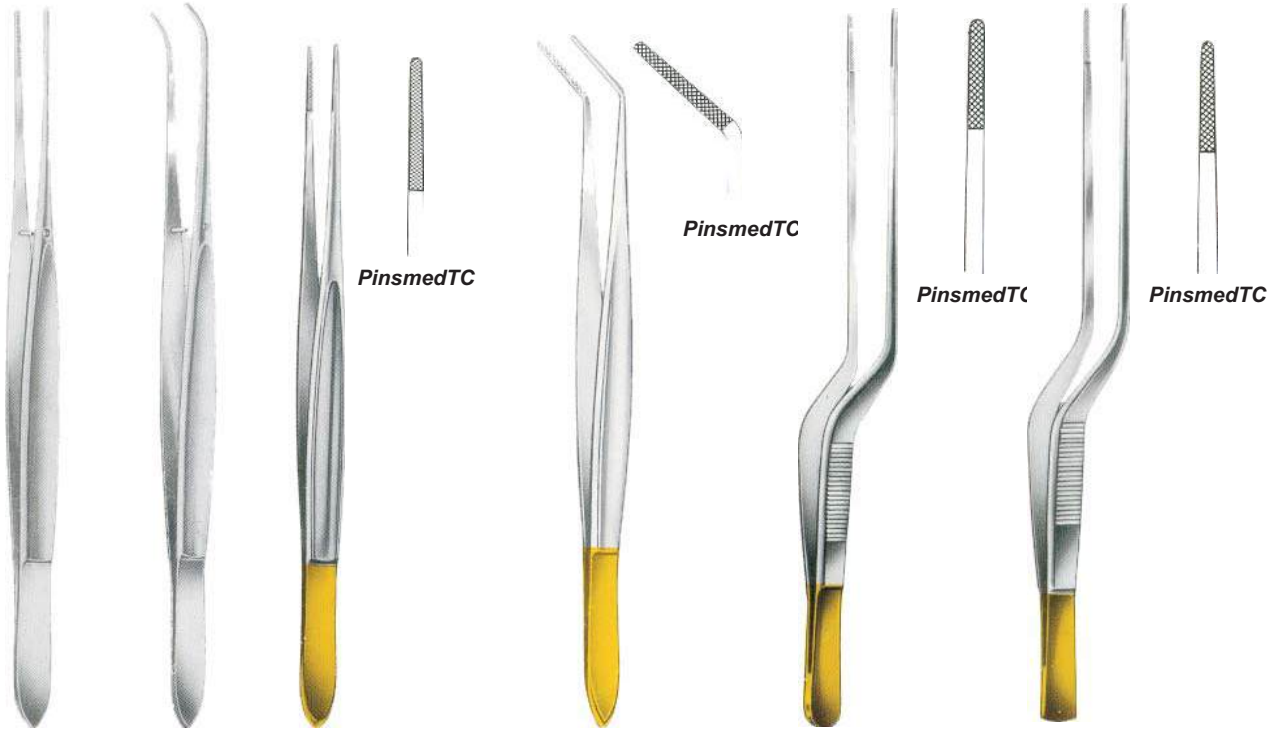

cm	in	Cushing	Cushing	Cushing	Cushing	Cushing-Taylor	Grunwald
18.0	7	15-02916-18	15-02917-18	15-02920-18	15-02923-18	15-02927-18	15-02929-18

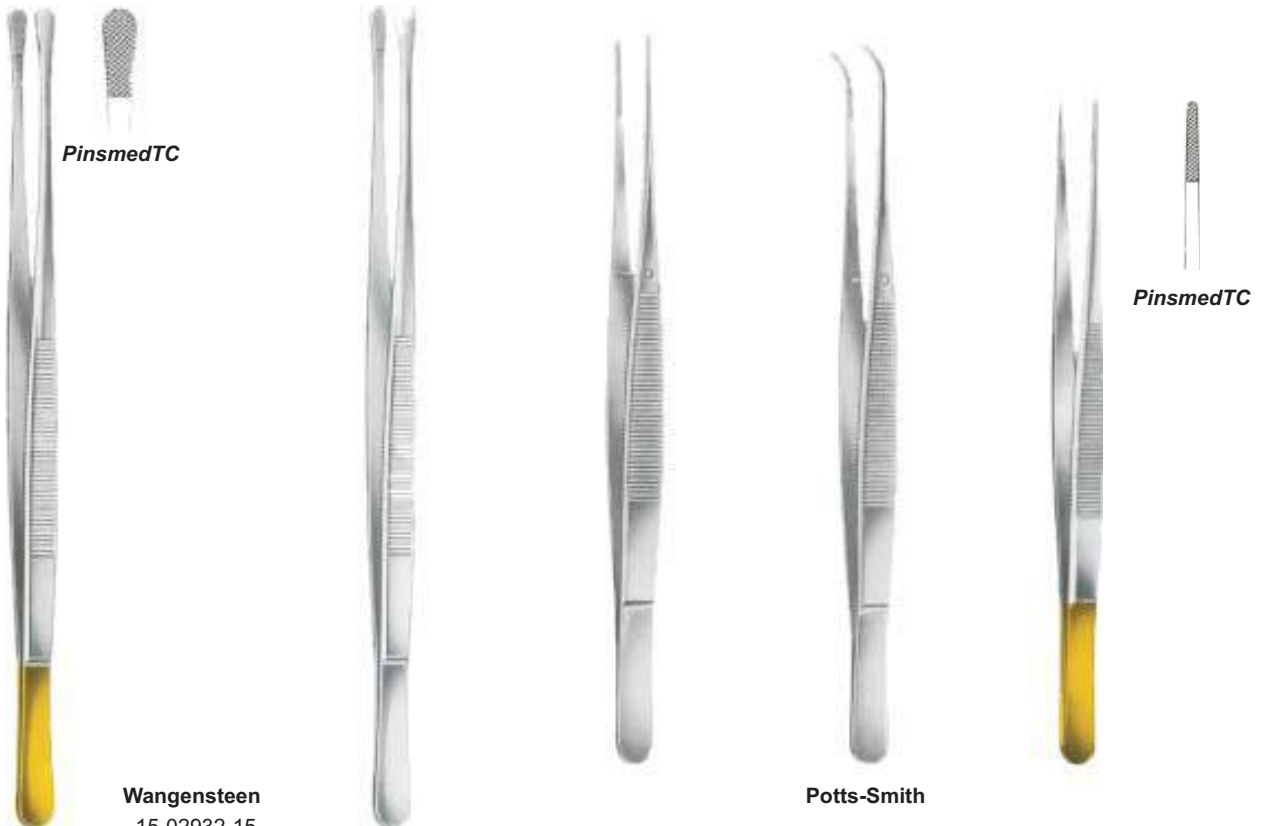

cm	in	Wangensteen		Potts-Smith		
15.0	6"	15-02932-15				
18.0	7"		15-02936-18	15-02940-18	15-02944-18	15-02948-15
20.0	8"					15-02948-18
21.0	8¼"			15-02940-21	15-02944-21	15-02948-20
23.0	9"	15-02932-23	15-02936-23			15-02948-23
25.0	10"	15-02932-25		15-02940-25	15-02944-25	15-02948-25



cm	in	Standard 1:2	Oehler 1:2	Standard 2:3	Standard 3:4	Standard 4:5	Standard 1:2
10.5	4¼"	15-02952-10					
11.5	4½"	15-02952-11					
13.0	5"	15-02952-13		15-02960-13	15-02964-13	15-02968-13	15-02972-13
14.5	5¾"	15-02952-14	15-02956-14	15-02960-14	15-02964-14	15-02968-14	15-02972-14
15.0	6"	15-02952-15					
16.0	6¼"	15-02952-16	15-02956-16	15-02960-16	15-02964-16	15-02968-16	15-02972-16
18.0	7"	15-02952-18	15-02956-18	15-02960-18			15-02972-18
20.0	8"	15-02952-20	15-02956-20	15-02960-20			15-02972-20
25.0	10"	15-02952-25	15-02956-25	15-02960-25			15-02972-25
30.0	12"	15-02952-30	15-02956-30	15-02960-30			

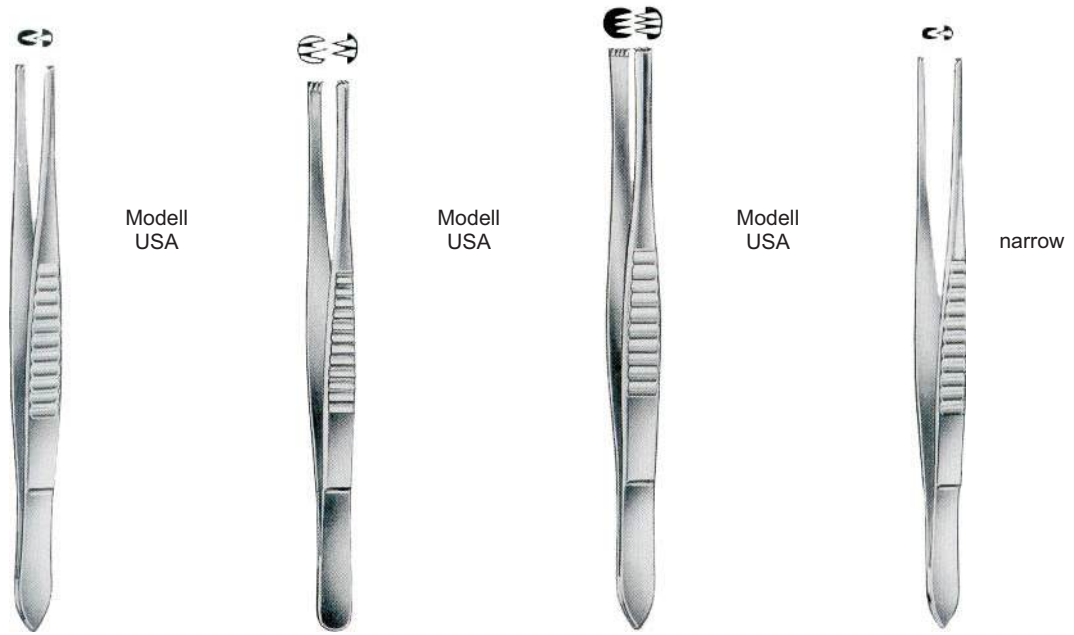

Standard

cm	in	1:2	2:3	3:4	1:2
12.0	4 ³ / ₄ "	15-02976-12	15-02980-12		
13.0	5"	15-02976-13	15-02980-13		15-02988-13
14.5	5 ³ / ₄ "	15-02976-14	15-02980-14	15-02984-14	15-02988-14
15.5	6"	15-02976-15			15-02988-15
18.5	7 ¹ / ₄ "	15-02976-18	15-02980-18		
21.0	8 ¹ / ₄ "	15-02976-21	15-02980-21		
25.0	10"	15-02976-25	15-02980-25		
31.0	12 ¹ / ₄ "	15-02976-31	15-02980-31		



cm	in	Lerche	Stone	Treves
13.0	5"			15-03000-13
15.0	6"	15-02992-15	15-02996-15	15-03000-15

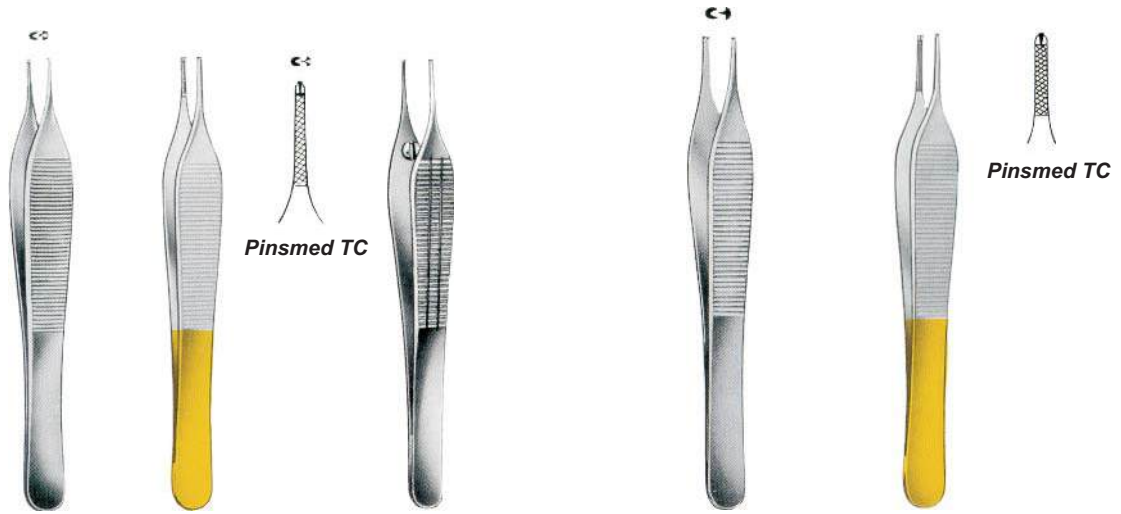

		Micro-Adson			Ewald	Standard-Adson
cm	in					
12.0	4¾"	15-03004-12	15-03008-12	15-03012-12	15-03016-12	15-03020-12
15.5	6"	15-03004-15	15-03008-15	15-03012-15		15-03020-15

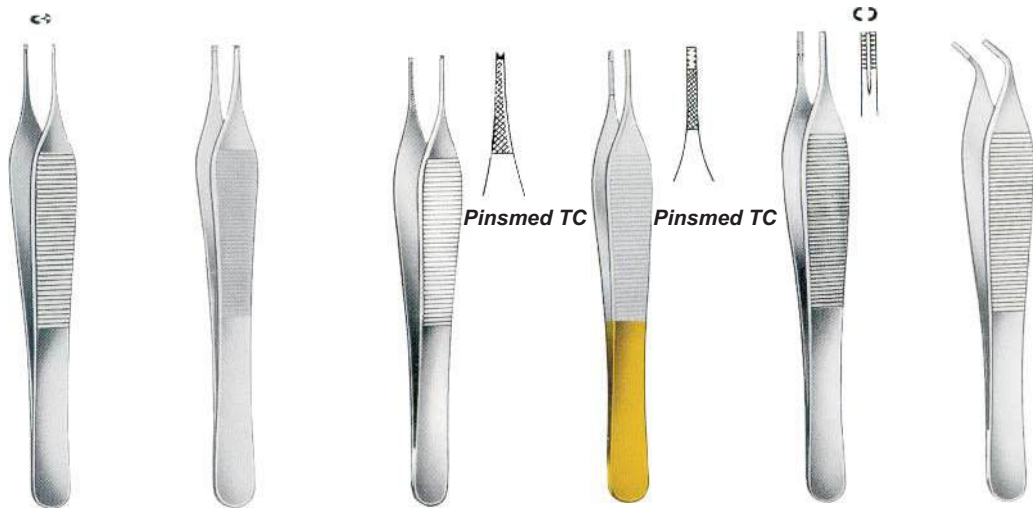

		Adson			Adson-Brown		
cm	in						
12.0	4¾"	15-03024-12	15-03028-12	15-03032-12	15-03036-12	15-03040-12	15-03041-12
15.0	6"	15-03024-15	15-03028-15				



Gillies
15-03046-15 15 cm/6"



Gillies
15-03050-15 15 cm/6"



Pinsmed TC



Brown
15-03054-15 15 cm/6"
15-03054-20 20 cm/8"
15-03054-25 25 cm/10"



Semken
15-03058-12 12 cm/4¾" 15-03062-12
15-03058-15 15 cm/6" 15-03062-15



Adlerkreutz
15-03066-15 15 cm/6"
15-03066-20 20 cm/8"
15-03066-25 25 cm/10"



Adlerkreutz
15-03070-15 15 cm/6"
15-03070-20 20 cm/8"
15-03070-25 25 cm/10"



Taylor
15-03074-17 17.5 cm/7"



Taylor
15-03075-17 17.5 cm/7"



Taylor
15-03078-17 17.5 cm/7"



Taylor
15-03079-17 17.5 cm/7"



cm	in	Waugh	Brophy	Brophy	Gerald	Gerald
15	6"	15-03082-15				
18	7"	15-03082-18			15-03092-18	15-03093-18
20	8"	15-03082-20	15-03086-20	15-03087-20		

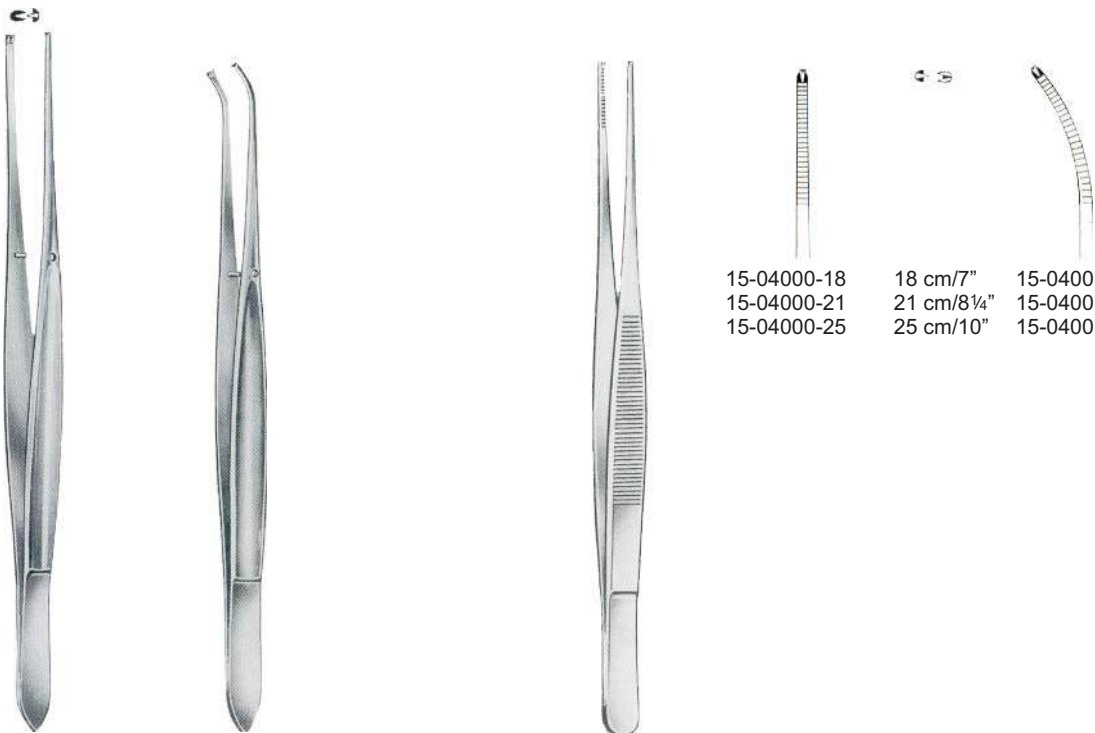

Cushing
15-03096-18
17.5 cm/7"

Cushing
15-03097-18
17.5 cm/7"

Potts-Smith

15-04000-18
15-04000-21
15-04000-25

18 cm/7"
21 cm/8¼"
25 cm/10"

15-04001-18
15-04001-21
15-04001-25



Duval
15-04004-14 14.5 cm/5¾"



Collin-Duval
15-04008-20 20 cm/8"

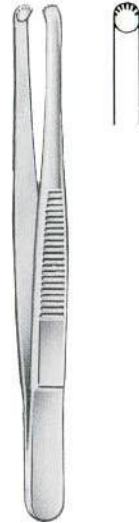

Durante
15-04012-14 14.5 cm/5¾"
15-04012-16 16.0 cm/6¼"
15-04012-20 20.0 cm/8"



Russ. Modell
15-04016-15 15 cm/6"
15-04016-20 20 cm/8"
15-04016-25 25 cm/10"



Mayo
15-04020-23 23 cm/9"



Ferris-Smith
18 cm/7"

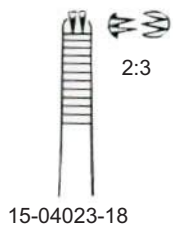

Lane
15-04026-14 14.5 cm/5¾"
15-04026-20 20.0 cm/8"
15-04028-14
15-04028-20



Grasping Forceps

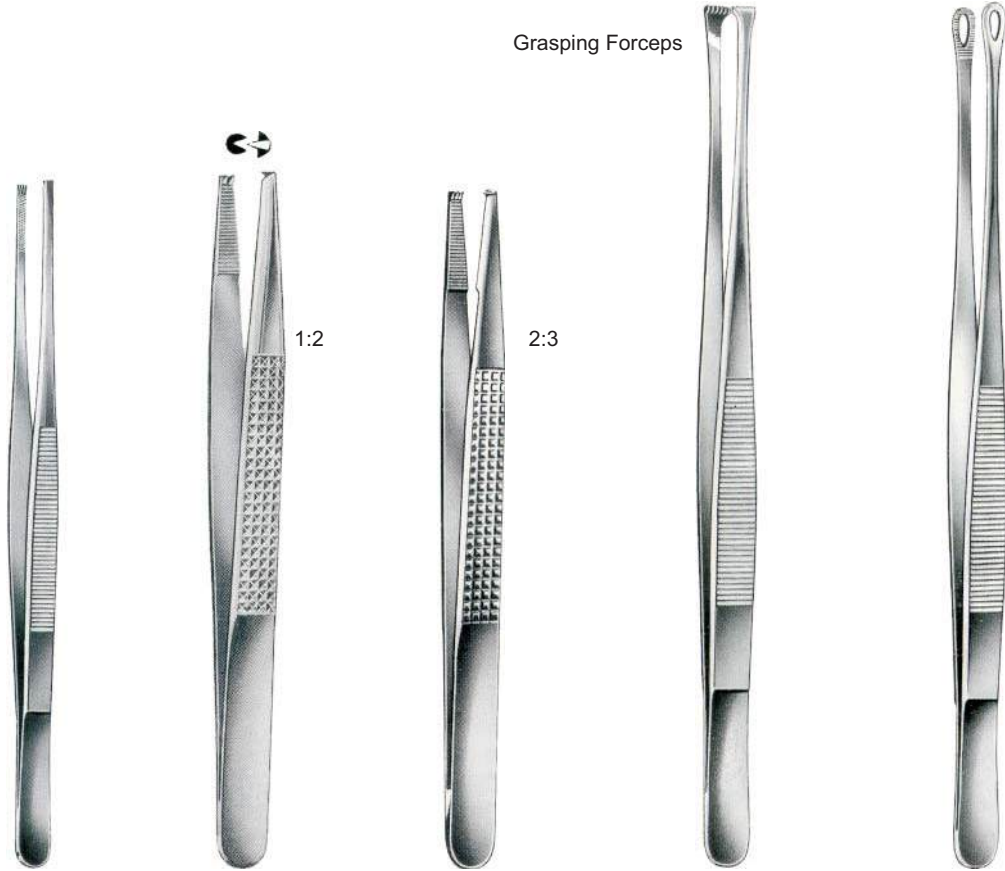

cm	in	Stille-Barraya	Bonney	Bonney	Nelson	Singley-Tuttle
15.0	6"				15-04042-15	
18.0	7"	15-04032-18	15-04036-18	15-04038-18	15-04042-18	15-04046-18
20.0	8"	15-04032-20			15-04042-23	
23.0	9"					15-04046-23
25.0	10"	15-04032-25				

Watchmaker's Forceps



No. 3
15-04050-03
11.5cm/4½"

No. 4
15-04050-04
11.5cm/4½"

No. 5
15-04050-05
11.5cm/4½"

No. 7
15-04050-07
11.5cm/4½"



cm	in					
10.5	4 1/4"	15-04054-10	15-04055-10	15-04057-10	15-04060-10	15-04061-10
						15-04063-10

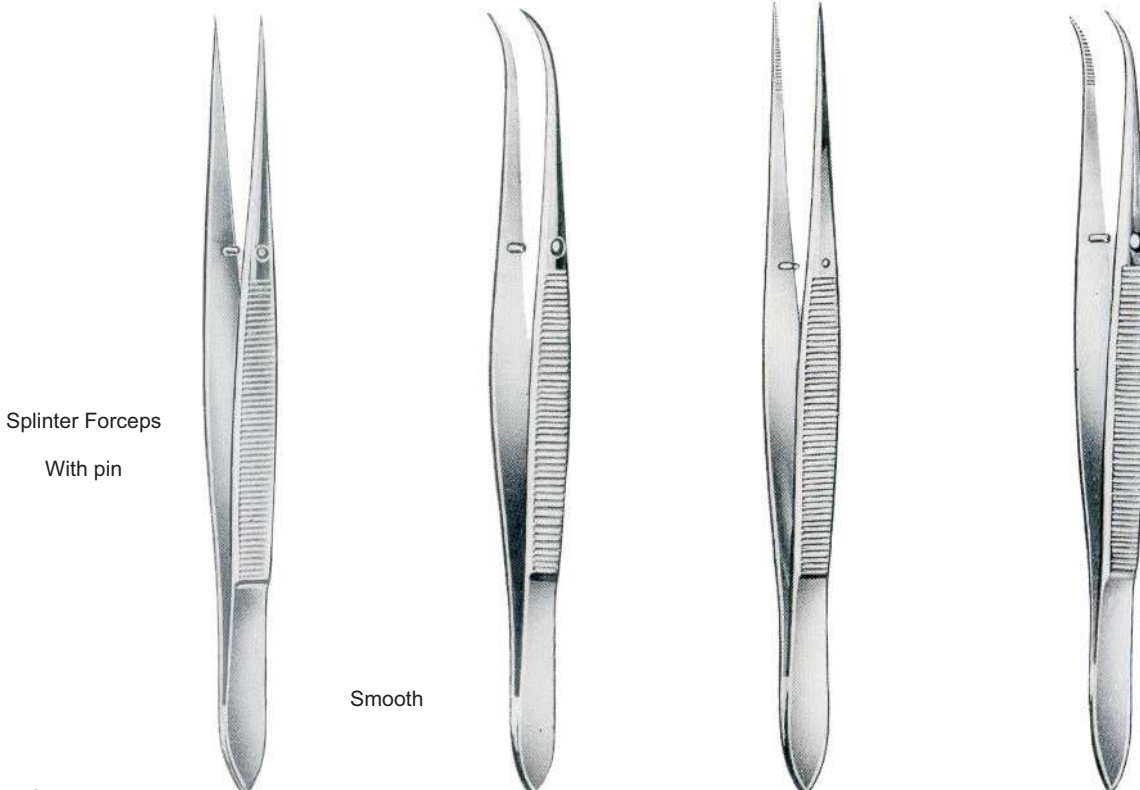

cm	in				
9.0	3 1/2"	15-04066-09	15-04067-09	15-04070-09	15-04071-09
10.5	4 1/4"	15-04066-10	15-04067-10	15-04070-10	15-04071-10
11.5	4 1/2"	15-04066-11	15-04067-11	15-04070-11	15-04071-11
12.5	5"	15-04066-12	15-04067-12	15-04070-12	15-04071-12



Feilchenfeld

15-04074-07 7.5cm/3"
15-04074-09 9.0cm/3½"
15-04074-11 11.5cm/4½"



Hunter

15-04078-10 10.5cm/4¼"



15-04079-10



Walter-Carmalt

15-04082-10 10.5cm/4¼" 15-04083-10



Peet
15-04087-11
11.5cm/4½"



Stieglitz
13.5cm/5¼"

Without Ratchet

15-04090-13



With Ratchet

15-04094-13



15-04091-13

15-04095-13



Ralk
15-04098-15
15cm/6"



Ralk
15-04099-15
15cm/6"

Ligature Forceps



Ochsner
15-04102-14
14.5cm/5¾"



Adson
15-04106-12
12cm/4¾"



Adson
15-04108-12
12cm/4¾"

Cilia Forceps



Beaupre
15-04111-12
12cm/4¾"



Henry
15-04115-12
12cm/4¾"



Gradle
15-04118-09
9.5cm/3¾"



Barraquer
15-04121-10
10.5cm/4¼"



Bennett
15-04124-07
7cm/2¾"



cm	in	Beer	Douglas	Ziegler	
8.0	3¼"	15-04128-08			
9.0	3½"	15-04128-09	15-04132-09	15-04136-09	15-04140-09



Kuehne
15-04144-10
10.5cm/4¼"

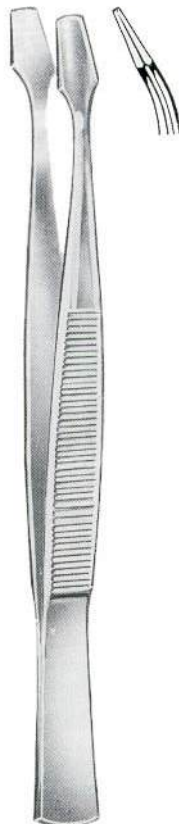

Kuehne
15-04145-10
10.5cm/4¼"



15-04148-10
10.5cm/4¼"



Atrauma

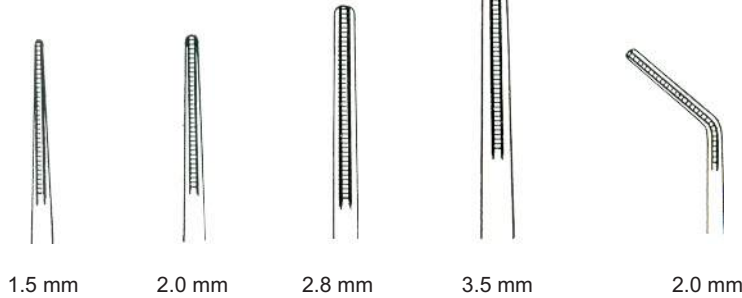

cm	in	1.5 mm	2.0 mm	2.8 mm	3.5 mm	2.0 mm
16.0	6¼"	15-04154-16	15-04156-16	15-04158-16	15-04160-16	15-04161-16
20.0	8"	15-04154-20	15-04156-20	15-04158-20	15-04160-20	15-04161-20
24.0	9½"	15-04154-24	15-04156-24	15-04158-24	15-04160-24	15-04161-24
30.0	12"	15-04154-30	15-04156-30	15-04158-30	15-04160-30	15-04161-30

Adson

15-04164-12	12cm/4¾"
15-04164-15	15cm/6"



cm	in	Troeltsch (Wilde)	Troeltsch	Lucae	Lucae	Jansen (Gruenwald)	Jansen
11.5	4½"	15-04167-11					
12.0	4¾"	15-04167-12	15-04171-12	15-04175-14	15-04177-14		
14.0	5½"						
15.0	6"	15-04167-15					
16.0	6¼"					15-04181-16	15-04183-16
18.0	7"	15-04167-18				15-04181-18	15-04183-18
20.0	8"					15-04181-20	15-04183-20



Jaw spoon, Shaped
3 mm 15-04187-03
5 mm 15-04187-05

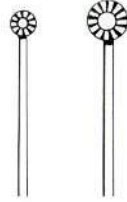

Jaw falt, Serrated
3 mm 15-04189-03
5 mm 15-04189-05



Curette Jaw, Toothed
3 mm 15-04191-03
5 mm 15-04191-05

Yasargil
22cm/8½"



1 x 0.5 mm Ø



1 x 0.5 mm Ø
15-04194-16



2 x 1 mm Ø



2 x 1 mm Ø

15cm/6"
18cm/7"
22cm/8¾"

15-04194-22

15-04196-22

15-04198-18
15-04198-22

15-04200-18
15-04200-22



Yasargil

22cm/8¾"
24cm/9½"

Ø 3 mm
15-04203-22
15-04203-24

Ø 5 mm
15-04205-22
15-04205-24

Ø 7 mm
15-04207-24

22cm/8¾"

Ø 3 mm
15-04209-22

Ø 3 mm
15-04211-22

Ø 5 mm
15-04213-22

Ø 5 mm
15-04215-22
22cm/8¾"



Yasargil

16cm/6 ¼"
18cm/7"
20cm/8"
22cm/8¾"
24cm/9½"



0.6 mm
15-04219-16
15-04219-18
15-04219-20
15-04219-22
15-04219-24



0.9 mm
15-04221-16
15-04221-18
15-04221-20
15-04221-22
15-04221-24



15-04223-18
18cm/7"



Dieffenbach
16-04226-03
3.5cm/1 1/2"
16-04226-05
5cm/2"



Dieffenbach
16-04227-03
3.5cm/1 1/2"
16-04227-05
5cm/2"

Straight

For Bulldog Clamps

- 16-04234-01 38mm/1 1/2"
- 16-04234-02 51mm/2"
- 16-04234-03 57mm/2 1/4"
- 16-04234-04 63mm/2 1/2"
- 16-04234-05 70mm/2 3/4"
- 16-04234-06 75mm/3"
- 16-04234-07 90mm/3 1/2"



Johns-Hopkins



Johns-Hopkins
16-04237-24
24.5cm/9 3/4"

Curved

- 16-04235-01 38mm/1 1/2"
- 16-04235-02 51mm/2"
- 16-04235-03 57mm/2 1/4"
- 16-04235-04 63mm/2 1/2"
- 16-04235-05 70mm/2 3/4"
- 16-04235-06 75mm/3"
- 16-04235-07 90mm/3 1/2"



Dieffenbach
16-04230-06
6cm/2 1/2"



Dieffenbach
16-04231-06
6cm/2 1/2"

Haemorrhoidal Clamps



Carrel
16-04240-10
10cm/4"



Chaput
16-04242-13
13cm/5"

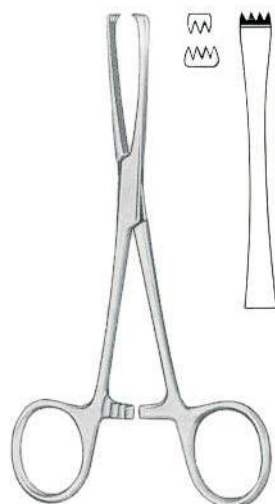

Tuffier
16-04246-13
13cm/5"



Pratt
16-04250-15
15cm/6"



Terrier
16-04254-10 10 cm/4"



Pennington
16-04258-15 15 cm/6"
16-04558-20 20 cm/8"



Peau
16-04262-12 12.5 cm/5"

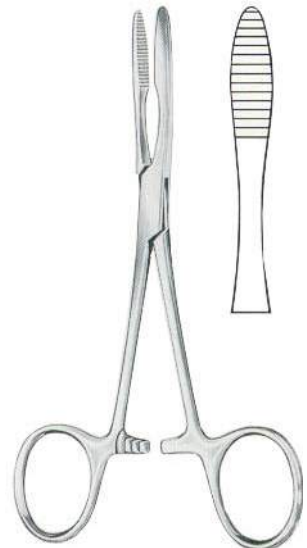

Peau
16-04266-14 14 cm/5³/₄"
16-04566-16 16 cm/6¹/₄"

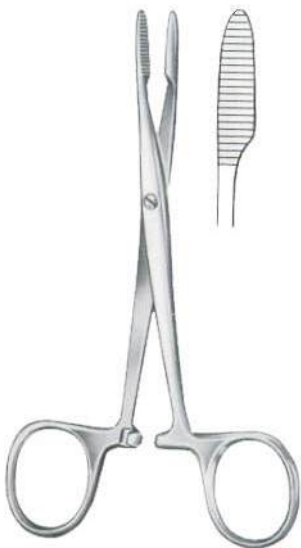

Peau
16-04270-14 14 cm/5¹/₂"

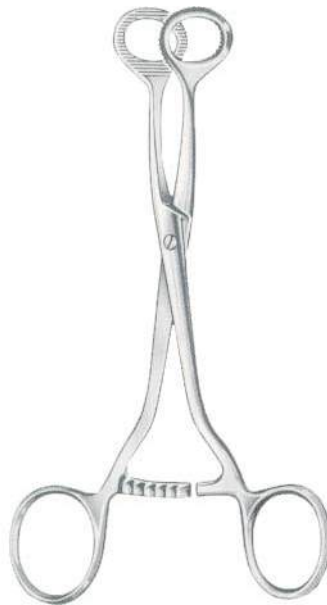

Collin
16-04274-15 15.5 cm/6"



Collin
16-04278-14 14 cm/5¹/₂"



Collin
16-04282-16 16.5 cm/6¹/₂"



Hartmann
10 cm/4"

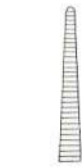

16-04286-10

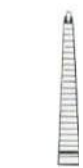

16-04290-10

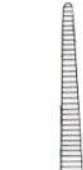

16-04294-12
16-04294-14



16-04295-12
16-04295-14



16-04287-10



16-04291-10



Halstead-Mosquito
12 cm/4¾"
14 cm/5½"

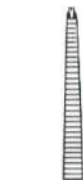

16-04298-12
16-04298-14



16-04299-12
16-04299-14



Micro-Mosquito
10 cm/4"
12 cm/4¾"



16-04302-10
16-04302-12



16-04303-10
16-04303-12



16-04306-10
16-04306-12



16-04307-10
16-04307-12



Jacobson-Halstead
13 cm/5"



16-04310-13



16-04311-13

Very fine

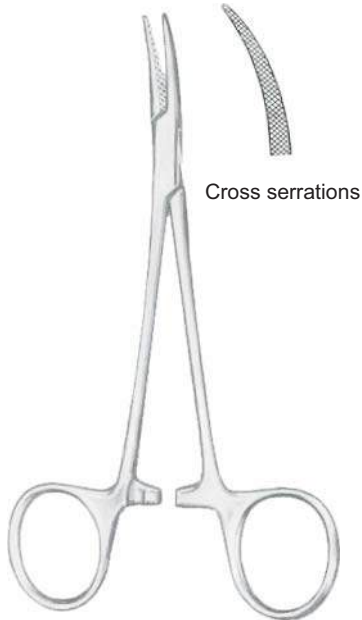

Cross serrations

16-04315-12
12 cm/4¾"



Halstead-Mosquito
18 cm/7"
21 cm/8¼"



16-04318-18
16-04318-21

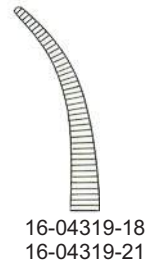

16-04319-18
16-04319-21



16-04322-18
16-04322-21



16-04323-18
16-04323-21



Kelly
14 cm/5½"

Kelly-Rankin
16 cm/6¼"

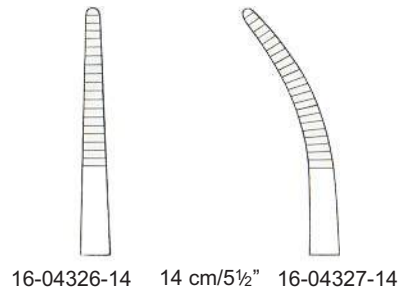

16-04326-14 14 cm/5½" 16-04327-14

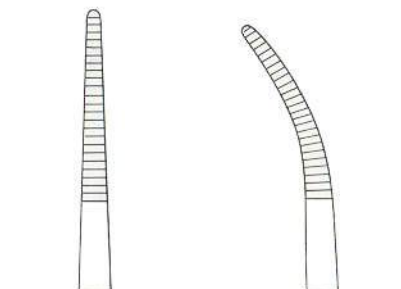

16-04330-16 16 cm/6¼" 16-04331-16



Crile
14 cm/5½"

Crile-Rankin
16 cm/6¼"

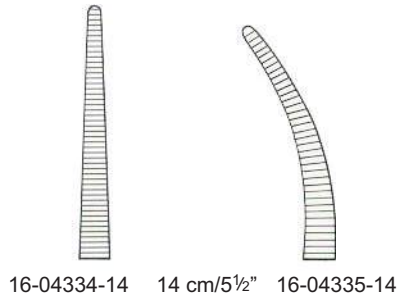

16-04334-14 14 cm/5½" 16-04335-14

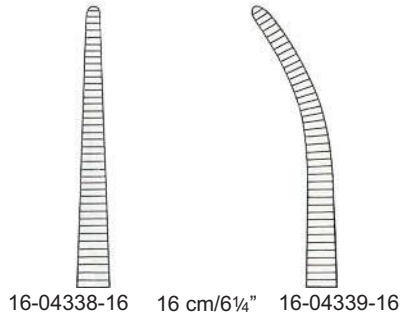

16-04338-16 16 cm/6¼" 16-04339-16



Baby-Crile
14 cm/5½"

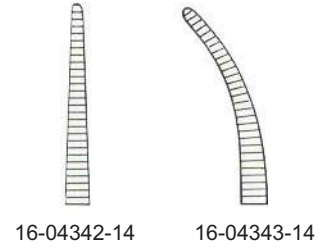

16-04342-14 16-04343-14



Crile
14 cm/5½"

Crile-Rankin
16 cm/6¼"

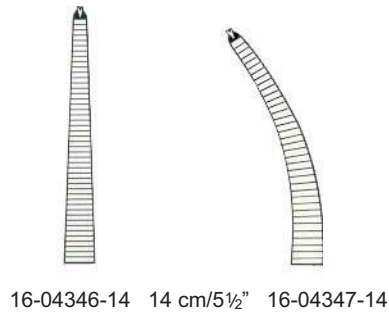

16-04346-14 14 cm/5½" 16-04347-14

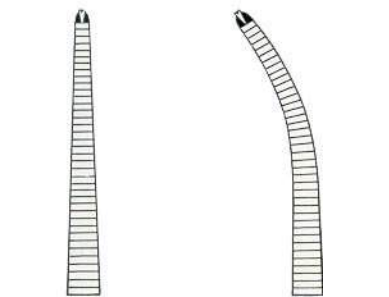

16-04350-16 16 cm/6¼" 16-04351-16



Baby-Crile
14 cm/5½"

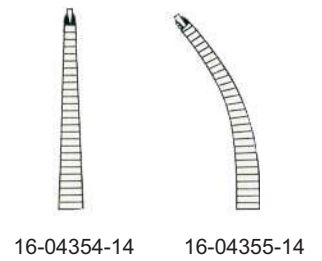

16-04354-14 16-04355-14



Coller-Crile



16-04358-14 14 cm/5½"



16-04362-16 16 cm/6¼"

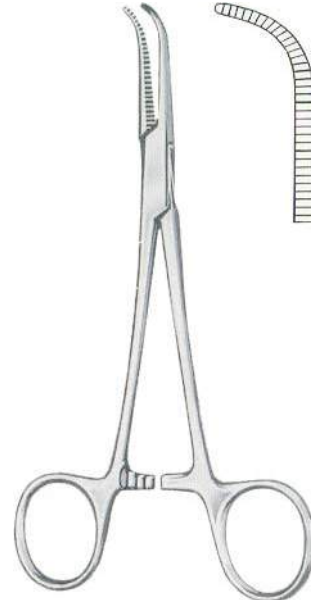

Coller-Crile
16-04367-16
16 cm/6¼"

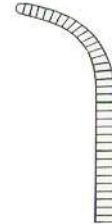

Leriche
15 cm/6"



16-04370-15



16-04371-15



16-04374-15



16-04375-15



Providence
14 cm/5½"



16-04378-14



16-04379-14

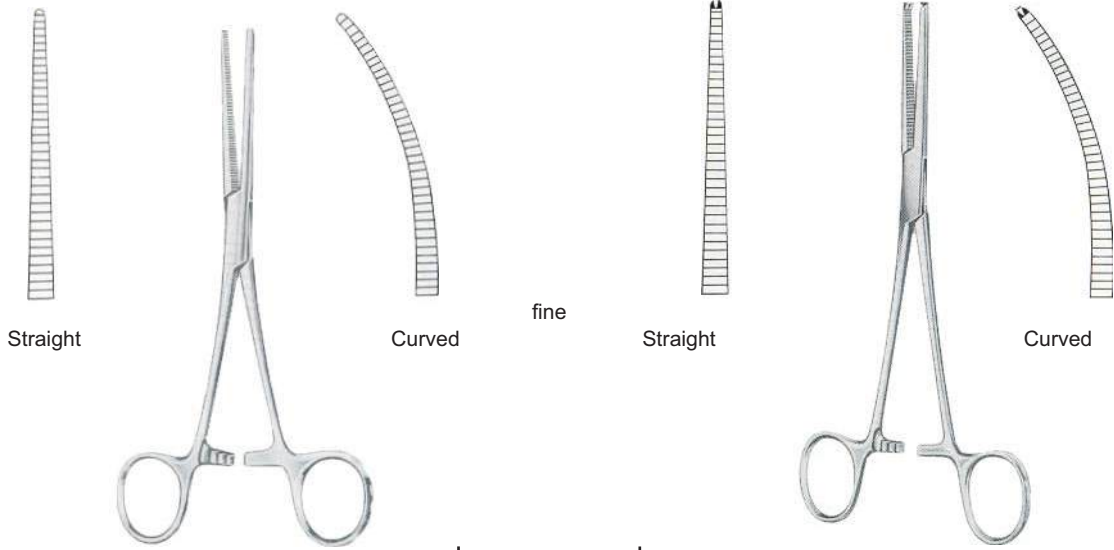

Rochester-Pean		cm	in	Ochsner-Kocher	
16-04382-13	16-04383-13	13.0	5"	16-04386-13	16-04387-13
16-04382-14	16-04383-14	14.0	5½"	16-04386-14	16-04387-14
16-04382-16	16-04383-16	16.0	6¼"	16-04386-16	16-04387-16

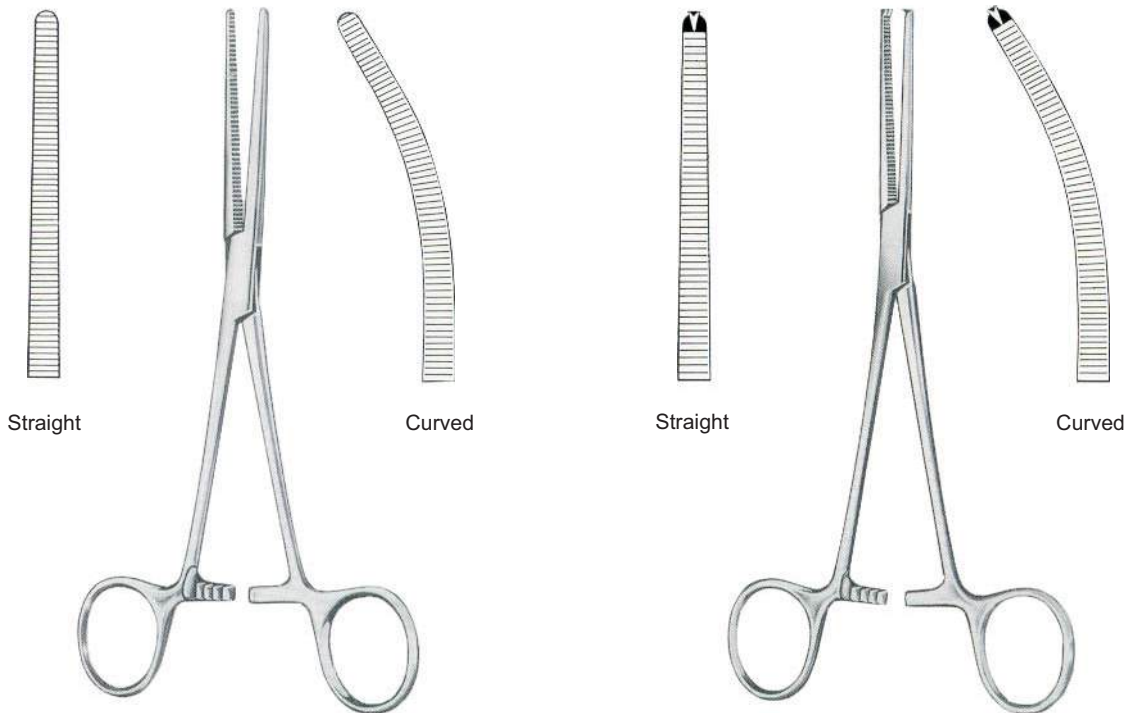

Rochester-Pean		cm	in	Ochsner-Kocher	
16-04390-13	16-04391-13	13.0	5"	16-04394-13	16-04395-13
16-04390-14	16-04391-14	14.0	5½"	16-04394-14	16-04395-14
16-04390-16	16-04391-16	16.0	6¼"	16-04394-16	16-04395-16
16-04390-18	16-04391-18	18.0	7"	16-04394-18	16-04395-18
16-04390-20	16-04391-20	20.0	8"	16-04394-20	16-04395-20
16-04390-22	16-04391-22	22.0	8¾"	16-04394-22	16-04395-22
16-04390-24	16-04391-24	24.0	9½"	16-04394-24	16-04395-24
16-04390-26	16-04391-26	26.0	10¼"	16-04394-26	16-04395-26
16-04390-30	16-04391-30	30.0	12"	16-04394-30	16-04395-30

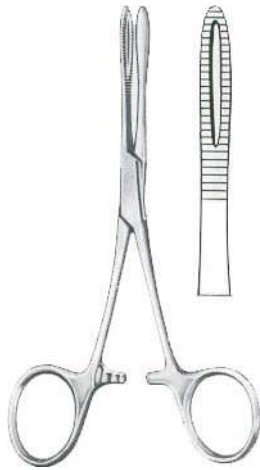
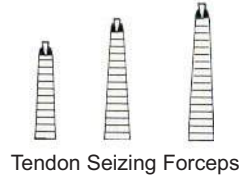

Kronlein
16-04398-13
13cm/5"



Brand
16-04402-15 15cm/6"
16-04402-19 19cm/7½"
16-04402-24 24cm/9½"



Brand
16-04403-15 15cm/6"
16-04403-19 19cm/7½"
16-04403-24 24cm/9½"

Lateral Curved

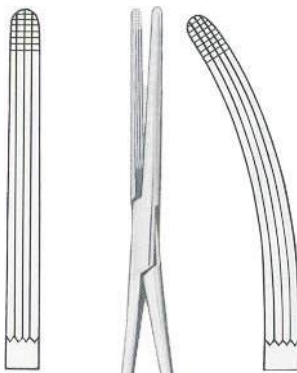

16-04406-16
16-04406-20

16-04407-16
16-04407-20



Rochester-Carmalt
16cm/6¼"
20cm/8"



16-04410-12



Mosquito-Dandy
12cm/4¾"



16-04412-12

16-04415-14

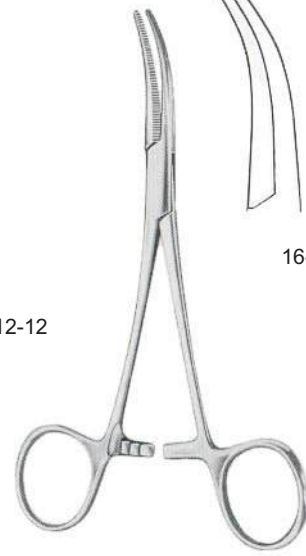

Dandy
14cm/5½"

16-04416-14



Lovlace
16-04420-15
15.5cm/6"



Dixon-Lovlace
16-04424-16
16cm/6¼"



Dixon-Lovlace
16-04426-16
16cm/6¼"

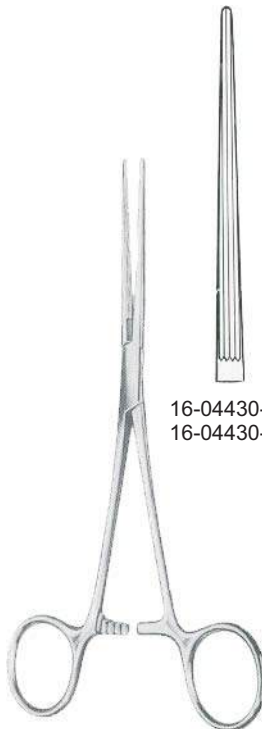

Bainbridge
15cm/6"
18cm/7"



16-04430-15
16-04430-18



16-04431-15
16-04431-18



Fuchsig
16-04435-19
19cm/7½"



Adson
18.5cm/7¼"



16-04438-18



16-04439-18



16-04442-18



16-04443-18



Nissen
16-04446-18 18.5cm/7¼"
16-04446-22 22.0cm/8¾"



Baby-Adson



16-04449-14
14cm/5½"



16-04451-18
18cm/7"

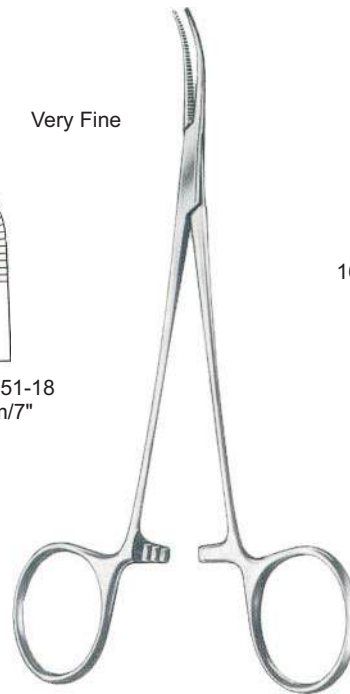

Jacobson-Adson
18cm/7"

Very Fine



16-04454-18



16-04455-18



16-04457-18



Schmidt
19cm/7½"

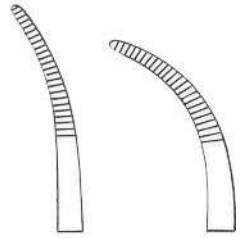

16-04461-19 16-04463-19



Schmidt
19cm/7½"

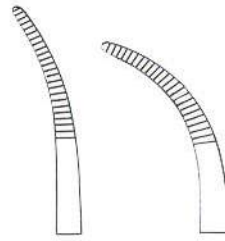

16-04467-19 16-04469-19

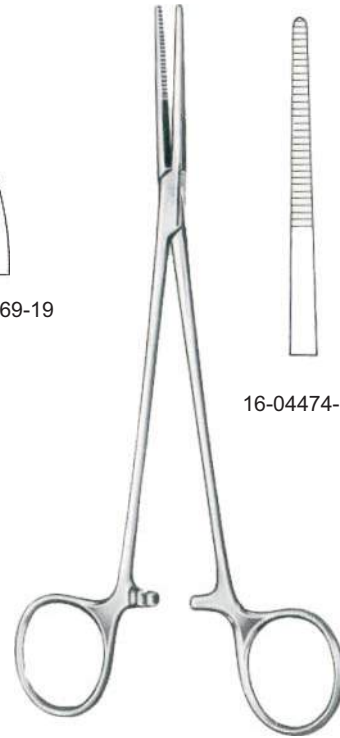

Birkett
19cm/7½"

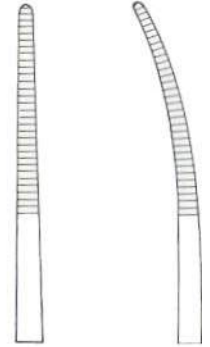

16-04474-19 16-04475-19



Bengolea

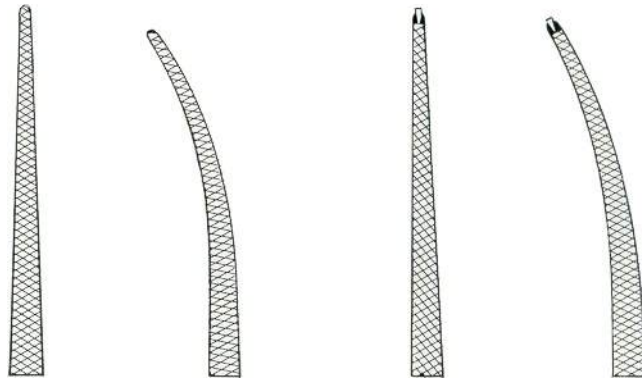

20cm/8"	16-04478-20	16-04479-20	16-04482-20	16-04483-20
22cm/8¾"	16-04478-22	16-04479-22	16-04482-22	16-04483-22
24cm/9½"	16-04478-24	16-04479-24	16-04482-24	16-04483-24
26cm/10¼"	16-04478-26	16-04479-26	16-04482-26	16-04483-26



Bridge
27cm/10½"



16-04486-27



16-04487-27



Roberts
22cm/8¾"



16-04490-22



16-04491-22



Kelly



19cm/7½"
22cm/8¾"
24cm/9½"

16-04495-19
16-04495-22
16-04495-24



16-04497-19
16-04497-22
16-04497-24



16-04499-19
16-04499-22
16-04499-24



Crafoord-Sellors

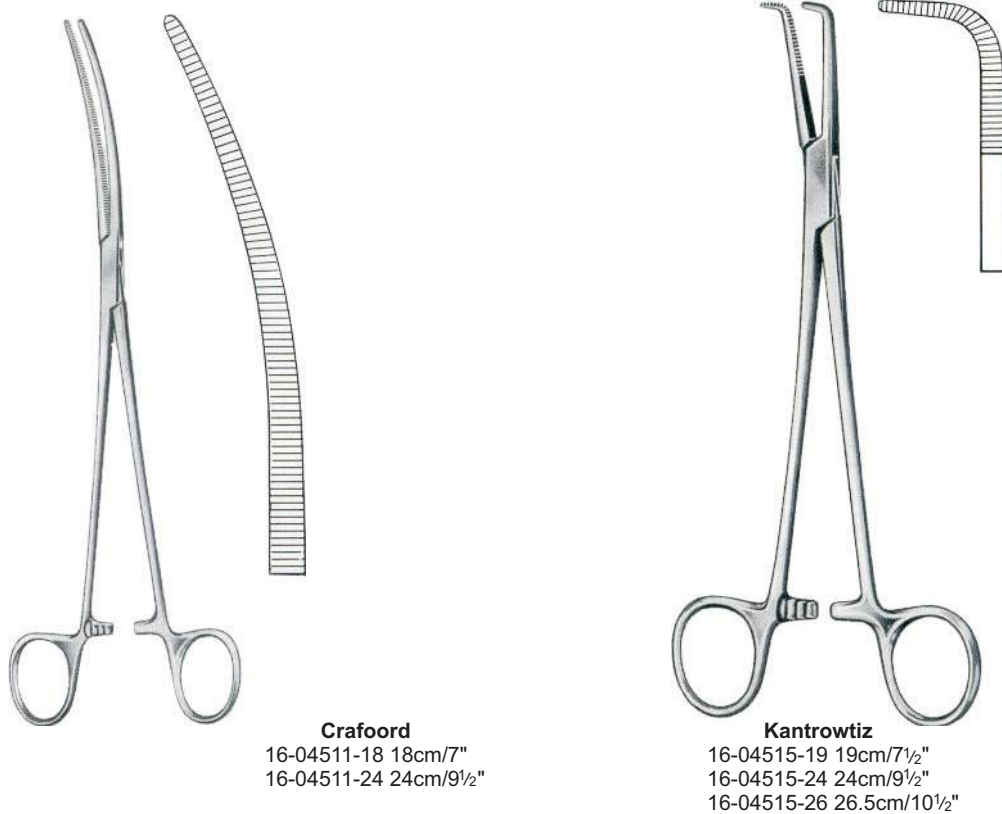



Rumel
23cm/9"



16-04519-23



16-04521-23



16-04523-23



16-04525-23

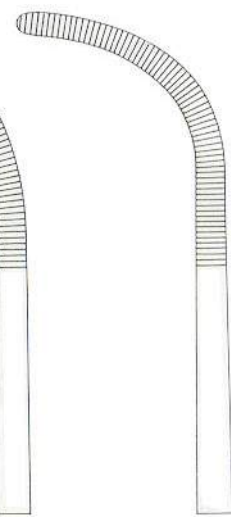

16-04527-23

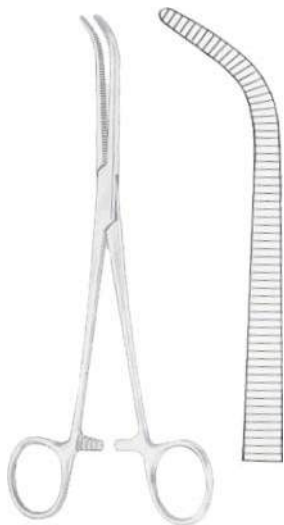

Johns Hopkins
16-04531-20
20cm/8"



Zenker
29.5cm/11½"

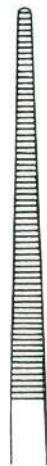

16-04534-29



16-04535-29

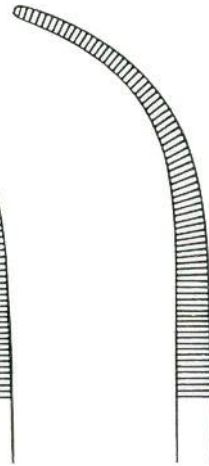

16-04537-29



Baby-Overholt
16-04541-13
13.5cm/5¼"



Overholt-Slim



16-04545-18
18.5cm/7¼"

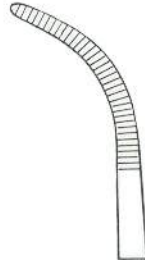

16-04547-20
20.5cm/8"

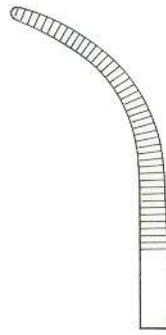

16-04549-21
21cm/8¼"

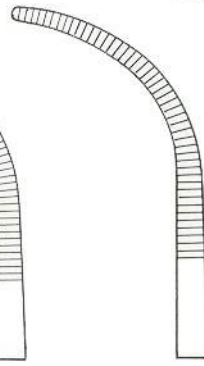

16-04551-21
21.5cm/8½"

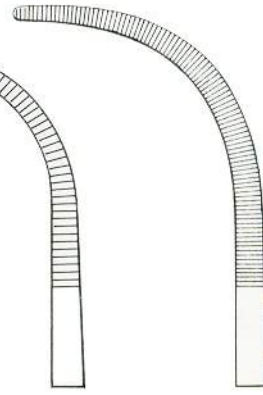

16-04553-24
24cm/9½"



Overholt-Slim



16-04557-18
18.5cm/7¼"



16-04559-20
20.5cm/8"

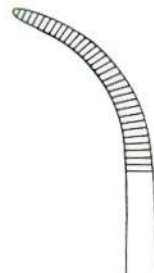

16-04561-21
21cm/8¼"

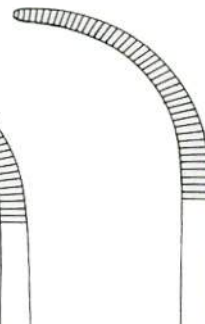

16-04563-21
21.5cm/8¼"





Overholt-Geissendorfer
21cm/8¼"
27cm/10½"

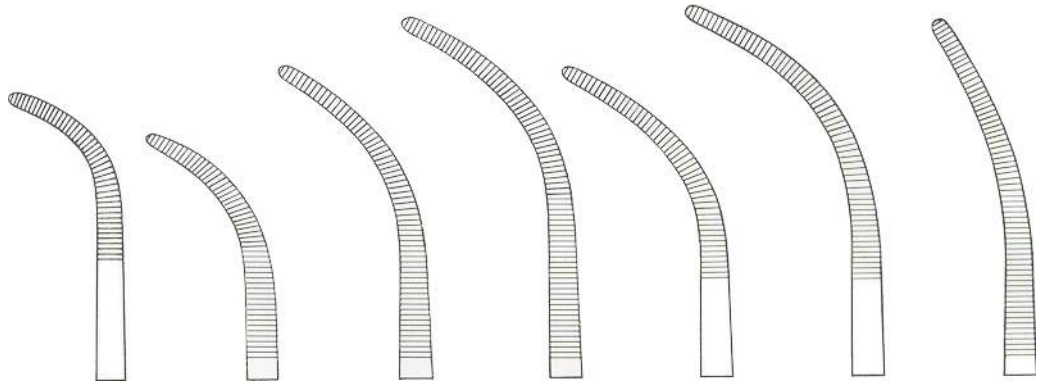

16-04567-21 16-04569-21 16-04571-21 16-04573-21 16-04575-21 16-04577-21 16-04579-21
16-04567-27 16-04569-27 16-04571-27 16-04573-27 16-04575-27 16-04577-27 16-04579-27



Overholt-Mixter
16-04581-21
21cm/8¼"

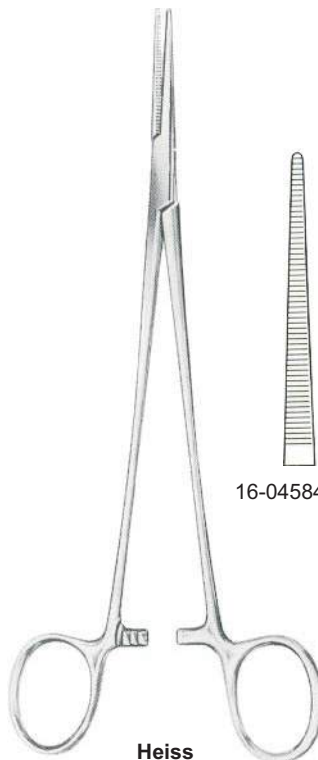

Heiss
20cm/8"

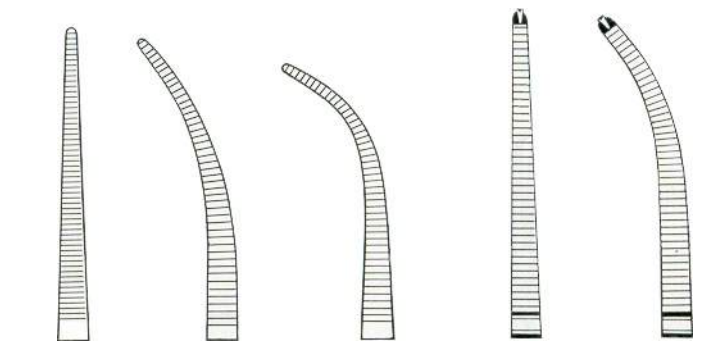

16-04584-20 16-04585-20 16-04587-20 16-04589-20 16-04591-20



Meeker
16-04595-27
27 cm/10½"

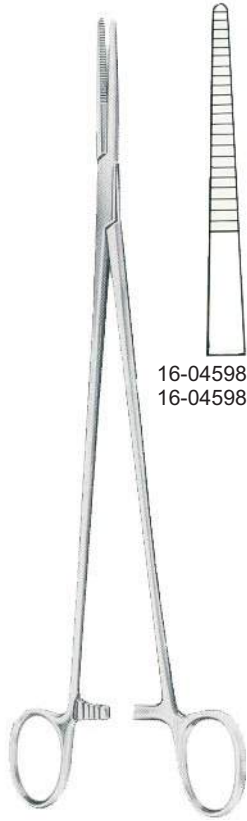

Toennis
21 cm/8¼"
26 cm/10¼"



16-04598-21
16-04598-27



16-04599-21
16-04599-27



16-04602-21
16-04602-27



16-04603-21
16-04603-27



Lower
16-04607-18
18 cm/7"



Gemini



16-04611-13
13 cm/5"



16-04611-18
18 cm/7"



16-04611-20
20 cm/8"



16-04611-23
23 cm/9"



16-04611-25
25 cm/10"

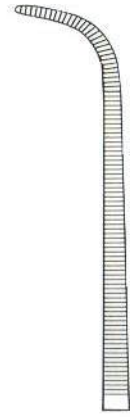

16-04611-27
27 cm/10½"



Mini-Gemini

16-04615-18
18 cm/7"



16-04615-22
22 cm/8¾"



16-04615-25
25 cm/10"



16-04615-28
28 cm/11"

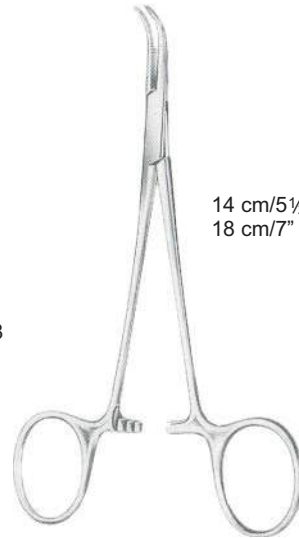

Baby-Mixer

14 cm/5½"
18 cm/7"



16-04619-14
16-04619-18



16-04621-14
16-04621-18



Mixer

16-04625-15 15 cm/6"
16-04625-19 19 cm/7½"



Mixer-O'Shaugnessy

16-04629-15 15.5 cm/6"
16-04629-19 19.0 cm/7½"

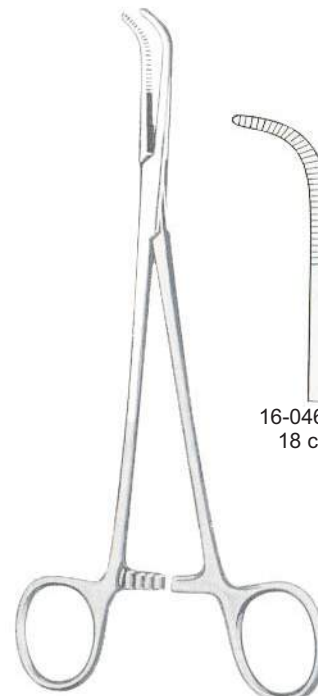

Mixer-Slim



16-04633-18
18 cm/7"



16-04633-23
23 cm/9"



16-04637-22
22 cm/8 3/4"

Mixer

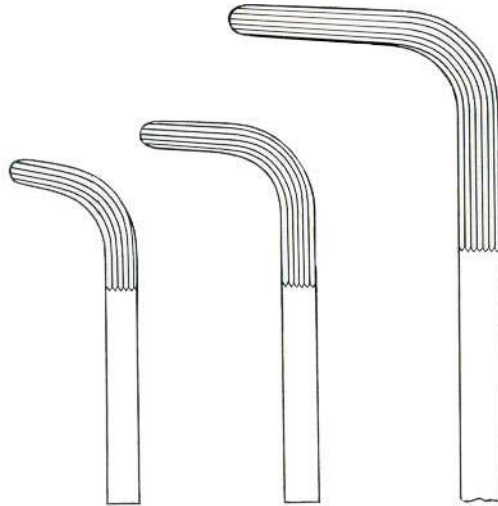

16-04637-25
25 cm/10"

16-04637-28
28 cm/11"



Mixer
16-04641-22
22 cm/8 3/4"



Wickstroem
16-04645-20
20 cm/8"



Finocchietto
16-04649-24
24 cm/9 1/2"



Mc Quigg-Mixer
16-04653-22
22 cm/8 3/4"



Lawrence
16-04657-27
27.5 cm/10¾"



Lahey (Sweet)

16-04661-19
19 cm/7½"

16-04663-23
23 cm/9"



Spencer-Wells

16-04664-13	13 cm/5"	16-04665-13
16-04664-15	15 cm/6"	16-04665-15
16-04664-18	18 cm/7"	16-04665-18
16-04664-20	20 cm/8"	16-04665-20
16-04664-23	23 cm/9"	16-04665-23



Spencer-Wells

16-04668-13	13 cm/5"	16-04669-13
16-04668-14	14 cm/5½"	16-04669-14
16-04668-15	15 cm/6"	16-04669-15
16-04668-18	18 cm/7"	16-04669-18
16-04668-20	20 cm/8"	16-04669-20
16-04668-23	23 cm/9"	16-04669-23

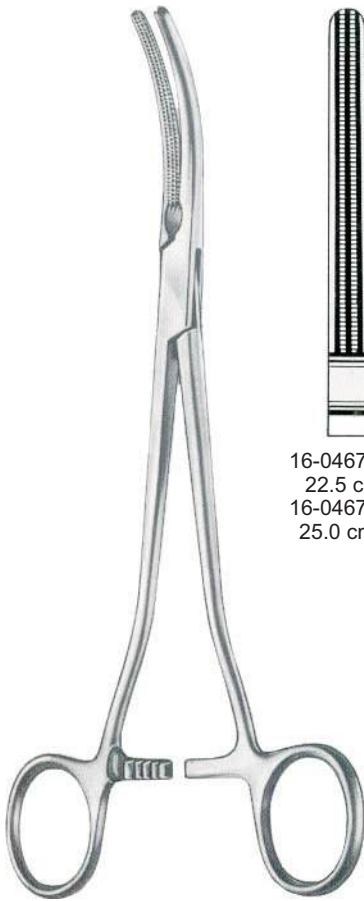

Rogers

16-04672-22
22.5 cm/9"
16-04672-25
25.0 cm/10"

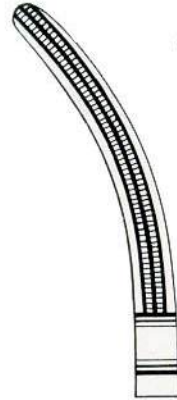
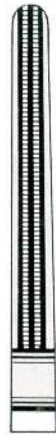

16-04673-22
22.0 cm/8 3/4"
16-04673-24
24.5 cm/9 3/4"

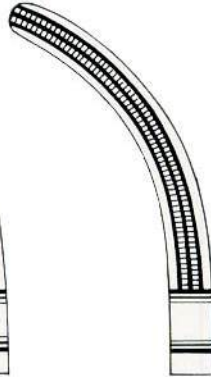

16-04675-21
21.5 cm/8 1/2"
16-04675-24
24.0 cm/9 1/2"

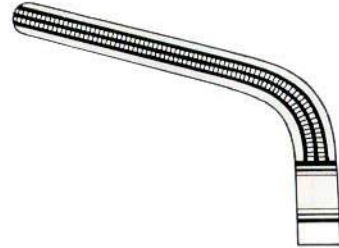

16-04679-20
20.5 cm/8"
16-04679-23
23.5 cm/9"



Heaney

19.5 cm/7 1/2"
21.5 cm/8 1/4"
23.5 cm/9"



16-04683-19
16-04683-21
16-04683-23



16-04685-19
16-04685-21
16-04685-23

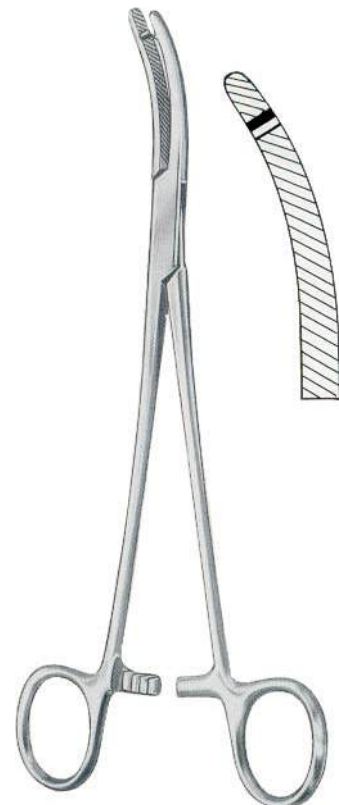

Heaney-Slim
16-04687-21
21 cm/8 1/4"



Ballentine
16-04690-21
21cm/8¼"



Heaney-Ballentine
16-04691-21
21cm/8¼"



Tonsil Forceps

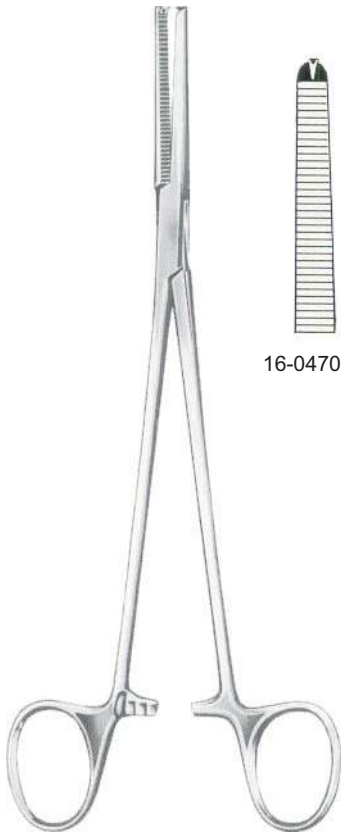

Fig. 1



Fig. 2

Negus
16-04695-19 19cm/7½" 16-04697-19



Phaneuf
21.5cm/8½"



16-04700-21

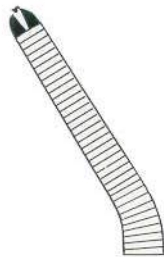

16-04701-21



Haemorrhoidal Clamps

	Straight		Curved
16cm/6¼"	16-04704-16	16-04705-16	
20cm/8"	16-04704-20	16-04705-20	

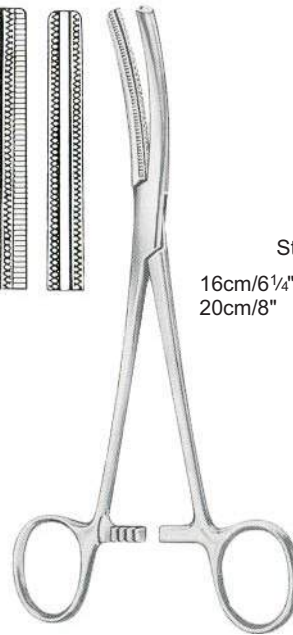

Fergusson

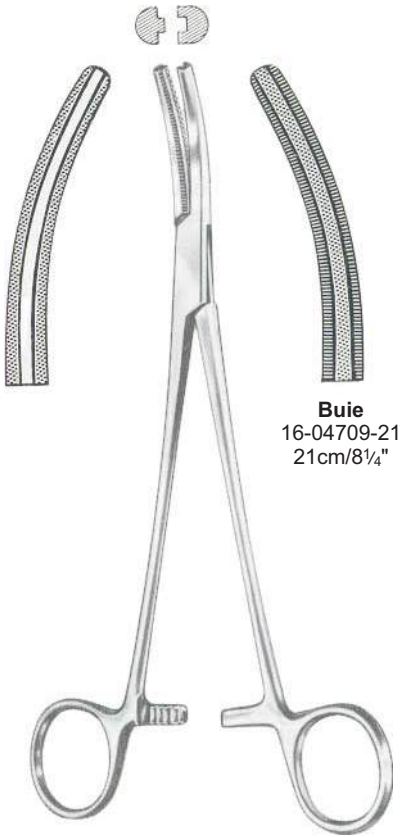

Buie
16-04709-21
21cm/8¼"

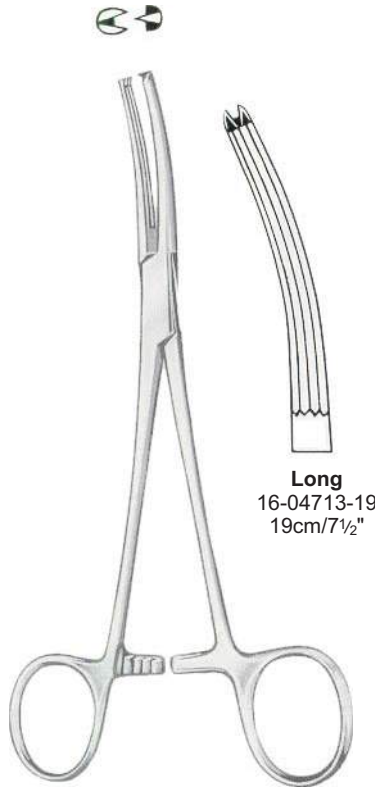

Long
16-04713-19
19cm/7½"



Garland
16-04717-21
21cm/8¼"

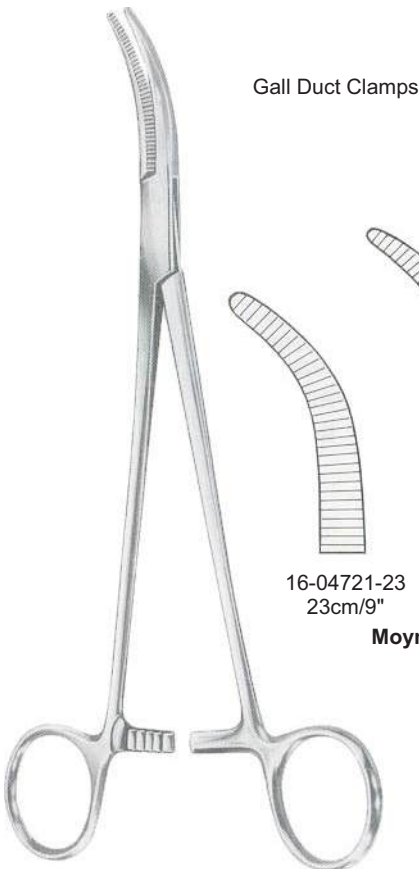

Gall Duct Clamps

16-04721-23 23cm/9"
16-04723-24 24cm/9½"

Moynihan



Hysterectomy Forceps

16-04726-23 16-04727-23

Hozlbach
23.5cm/9¼"



Pressure Clamps

Zweifel
16-04730-17
17.5cm/7"

Scalp Flap Forceps

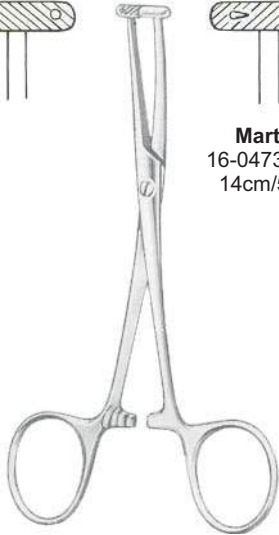

Martel
16-04733-14
14cm/5½"



Wertheim
16-04736-25
25cm/10"

Extra Strong



Wertheim-Cullen
16-04739-21
21.5cm/8½"



Wertheim
16-04743-24
24cm/9½"

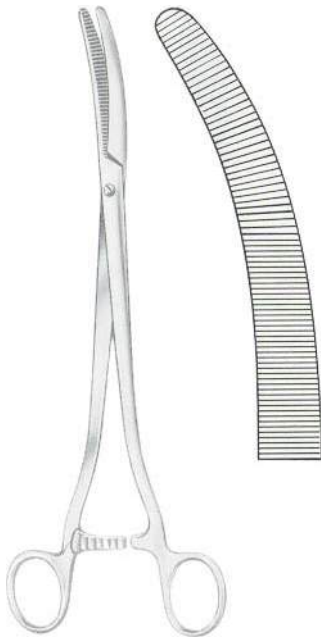

Faure
16-04747-25
25cm/10"



23cm/9"

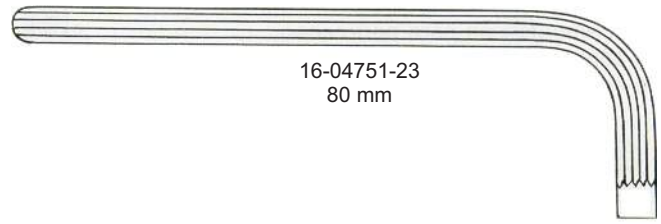

16-04751-23
80 mm

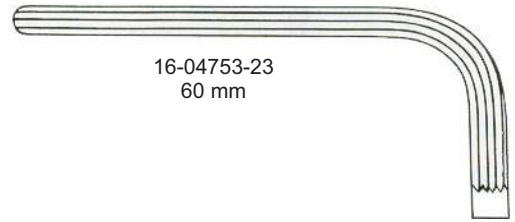

16-04753-23
60 mm



Wertheim
22cm/8¾"



Slightly Curved
16-04755-22



More Curved
16-04757-22

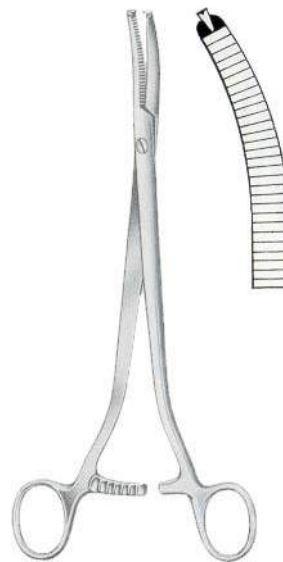

Wertheim
16-04761-22
22cm/8¾"

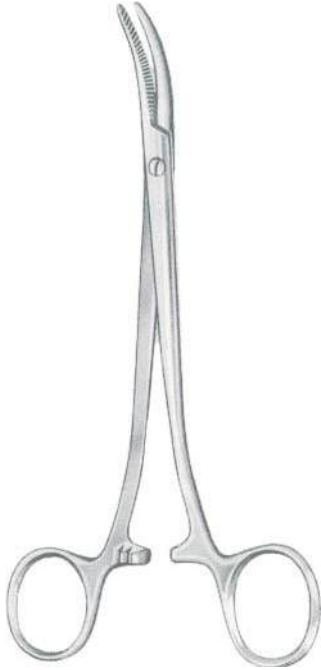

Wertheim
16-04765-18
18 cm/7"



Baby-Mikulicz
16-04769-14
14 cm/5½"

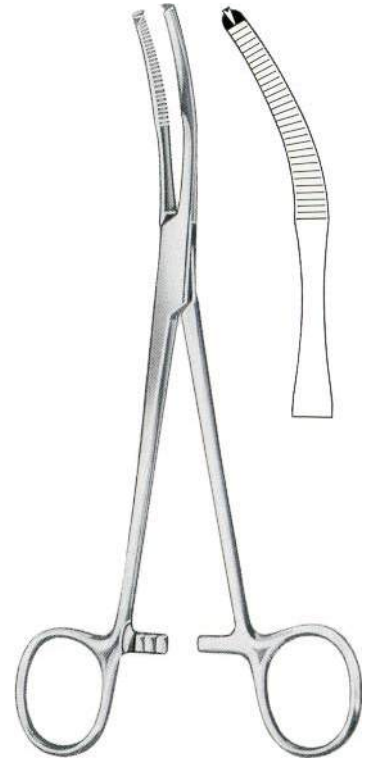

Mikulicz
16-04773-18 18cm/7"
16-04773-20 20cm/8"



Mikulicz
16-04777-20
20 cm/8"

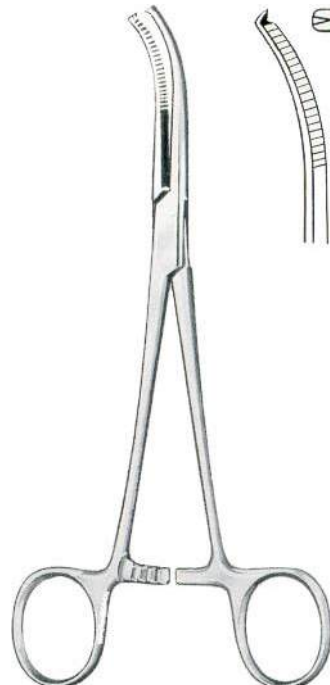

Mikulicz
16-04781-18
18.5 cm/7¼"

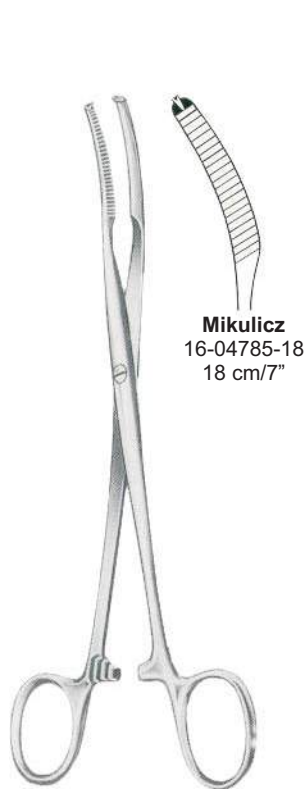

Mikulicz
16-04785-18
18 cm/7"

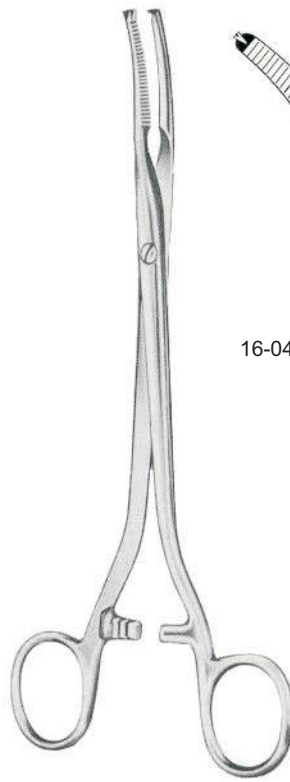

Mikulicz
16-04789-20 20 cm/8" 16-04791-20

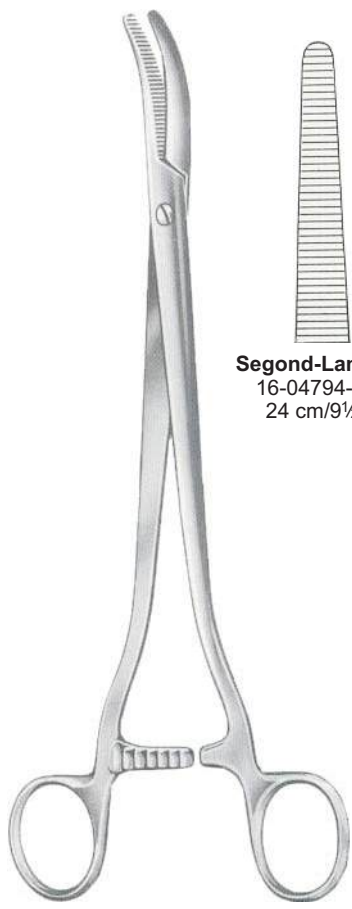
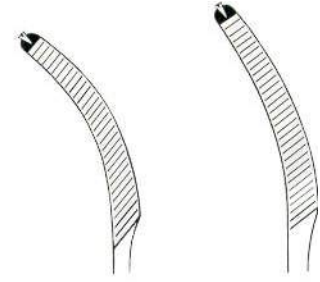

Segond-Landau
16-04794-24
24 cm/9½"



Segond
16-04795-24
24 cm/9½"

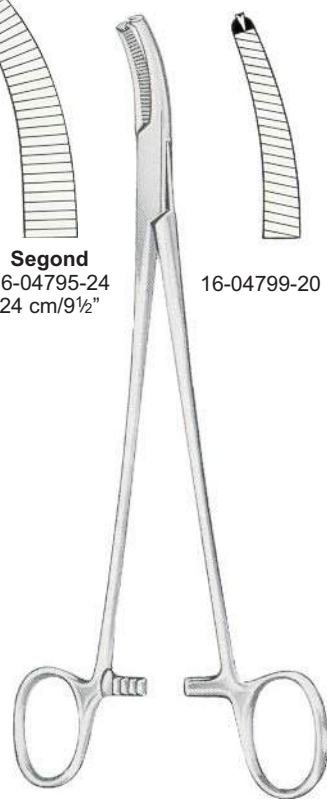

Faure
16-04799-20 20 cm/8" 16-04801-20

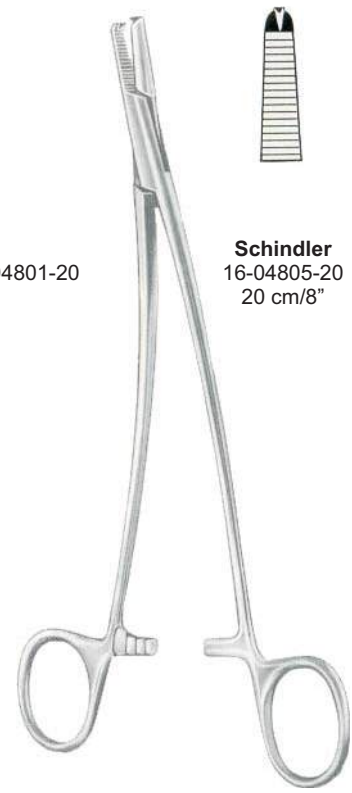

Schindler
16-04805-20
20 cm/8"





Schadel
16-04808-09
9 cm/3½"



Jones
16-04812-05 5 cm/2"
16-04812-09 9 cm/3½"



Engl-Modell
16-04816-09
9 cm/3½"



Backhaus
16-04820-09 9 cm/3½"
16-04820-11 11 cm/4½"
16-04820-13 13 cm/5"
16-04820-15 15 cm/6"

With clip for Tubing or Cable



16-04824-11 11 cm/4½"
16-04824-13 13 cm/5"



Peers-Bertram
16-04828-14
14.5 cm/5¾"



Tohoku
16-04832-10 10 cm/4"
16-04832-13 13 cm/5"



Roder
16-04836-13 13 cm/5"
16-04836-15 15 cm/6"



Lorna
16-04840-10 10 cm/4"
16-04840-13 13 cm/5"



Bernhard
16-04844-16 16.5 cm/6½"



Lane
16-04848-20
20 cm/8"



Doyen
16-04852-18
18 cm/7"



16-04856-14 14 cm/5½"
16-04856-15 15 cm/6"
16-04856-18 18 cm/7"
16-04856-20 20 cm/8"



16-04860-14
14.5 cm/5¾"

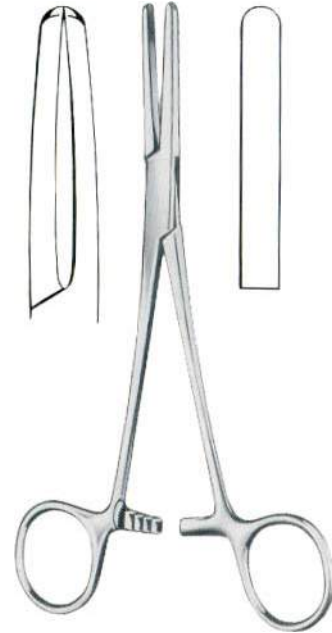

16-04864-16 16.5 cm/6½"
16-04864-18 18.0 cm/7"



16-04868-15 15 cm/6"
16-04868-18 18 cm/7"
16-04868-20 20 cm/8"



Mohr
16-04872-50 50 mm
16-04872-60 60 mm
16-04872-70 70 mm
16-04872-80 80 mm

Sizes
mm
13
17
20
25
30

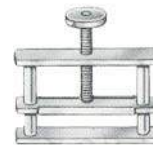

Hoffmann
16-04876-13
16-04876-17
16-04876-20
16-04876-25
16-04876-30



Hoffmann
16-04880-13
16-04880-17
16-04880-20
16-04880-25
16-04880-30



Ulrich

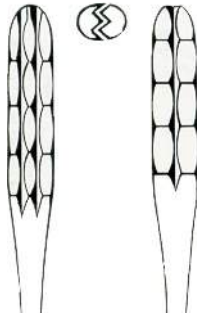

Straight

16-04884-22
16-04884-25
16-04884-27

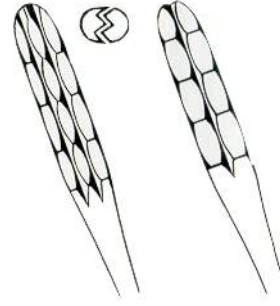

Curved

22 cm/8¾"
25 cm/10"
27 cm/10½"

16-04885-22
16-04885-25
16-04885-27



Lister

16-04888-13	13 cm/5"	16-04890-13
16-04888-15	15 cm/6"	16-04890-15
16-04888-18	18 cm/7"	16-04890-18



Bryant

16-04894-13
13 cm/5"

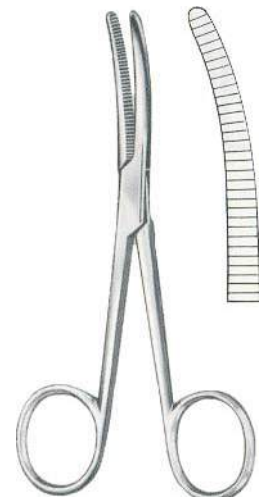

Bryant

16-04896-13
13 cm/5"



Gross-Maier



Straight

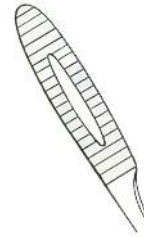

Curved

With Ratchet

16-04900-20
16-04900-25

20 cm/8"
25 cm/10"

16-04901-20
16-04901-25

Without Ratchet

16-04904-20
16-04904-25

20 cm/8"
25 cm/10"

16-04905-20
16-04905-25



Pelkmann
25 cm/10"



16-04908-25



16-04909-25

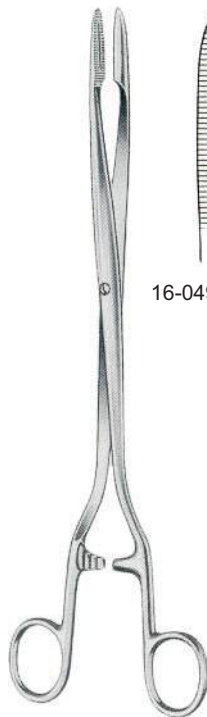

Sims-Maier
28 cm/11"



16-04912-28



16-04913-28



Duplay
20 cm/8"



16-04916-20



16-04917-20

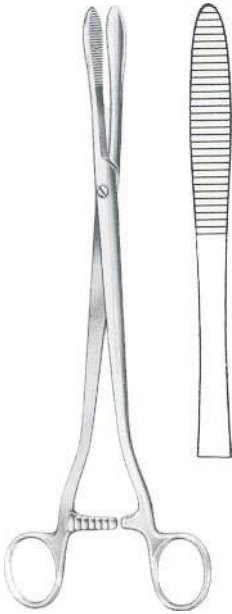

Collin
16-04920-25
25cm/10"

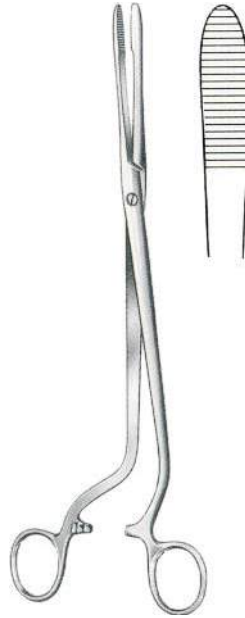

Cheron
16-04924-25
25cm/10"



Emmet
16-04928-21
21cm/8 1/4"



Bozemann
16-04932-26
26cm/10 1/4 "



Bozemann
26cm/10 1/4 "



16-04935-26



16-04937-26

Smooth

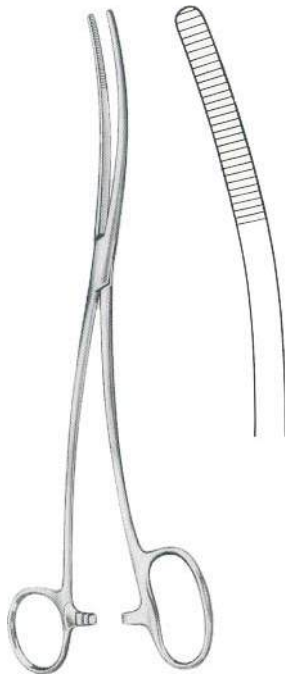

Bozemann-Douglas
16-04941-26
26cm/10¼"

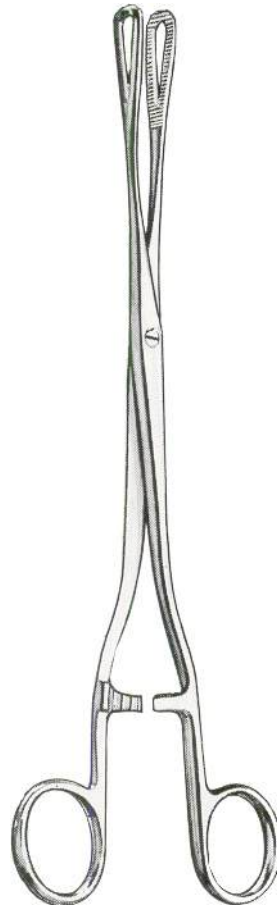

Rampley
16-04944-18 18cm/7"
16-04944-24 24cm/9½"



Rampley
16-04946-18 18cm/7"
16-04946-24 24cm/9½"



Foerster

18 cm/7"
20 cm/8"
24 cm/9½"
25 cm/10"

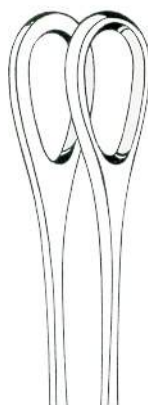

16-04950-18
16-04950-20
16-04950-24
16-04950-25

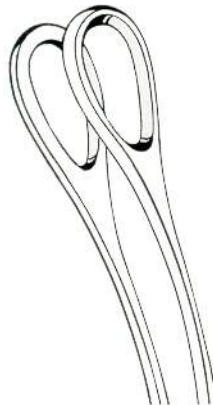

16-04951-18
16-04951-20
16-04951-24
16-04951-25

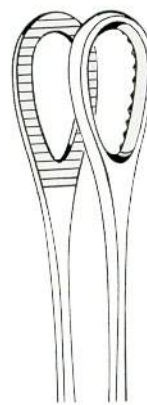

16-04954-18
16-04954-20
16-04954-24
16-04954-25

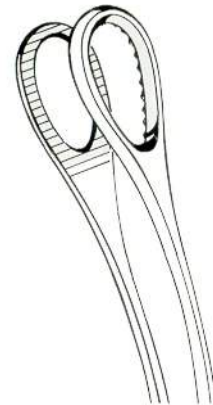

16-04955-18
16-04955-20
16-04955-24
16-04955-25



Schwartz
16-04959-19
19cm/7½"



16-04962-01



16-04962-02



16-04962-03

Applying Forceps



16-04966-23
23cm/9"



Diethrich



16-04970-08



16-04970-12



16-04970-20



16-04971-08



16-04971-12



16-04971-20

Atrauma



16-04974-10



16-04974-14



16-04974-20



16-04975-10



16-04975-14



16-04975-20



Miller
13.5cm/5¼"



Sharp
17-04979-13

Blunt
17-04980-13



Crile
17-04984-20
20cm/8"



Cushing

19cm/7½"
28cm/11"



17-04988-19
17-04988-28



17-04990-19
17-04990-28



Kilner
17-04993-15
15cm/6"



Fig. 1

Gillies
17-04995-18
18cm/7"



Fig. 2

Gillies
17-04997-18
18cm/7"



Sharp

Frazier
17-05001-13
17-05001-18



Blunt

13cm/5"
18cm/7"
17-05002-13
17-05002-18

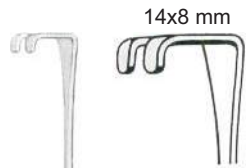

17-05006-16
16cm/6¼"



17-05010-08
8 mm



17-05010-10
10 mm



17-05014-12
12 mm



17-05014-14
14 mm



17-05010-12
12 mm

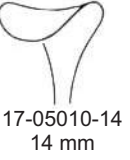

17-05010-14
14 mm



17-05014-16
16 mm



17-05014-18
18 mm



17-05010-16
16 mm



17-05010-18
18 mm



Sharp



Blunt

Graefe
17-05017-16 16cm/6¼" 17-05018-16



17-05021-16
16cm/6¼"



17-05023-16
16cm/6¼"



O, Connor
17-05025-16
16cm/6¼"



Guthrie
17-05029-16 16cm/6¼" 17-05031-16



17-05035-16
16cm/6¼"



17-05037-16
16cm/6¼"



Mini-Langenbeck
16 cm/6¼"



17-05040-10
10x6 mm



17-05040-17
17x5 mm



17-05040-20
20x6 mm



17-05040-22
22x8 mm



Sharp

17-05043-01



Blunt

17-05044-01



17-05043-02



17-05044-02



17-05043-03



17-05044-03



17-05043-04



17-05044-04

Flexible



17-05047-02



17-05047-03



17-05047-04



17-05048-02



17-05048-03



17-05048-04

Sharp

Blunt



17-05051-04

Sharp



17-05052-04

Blunt

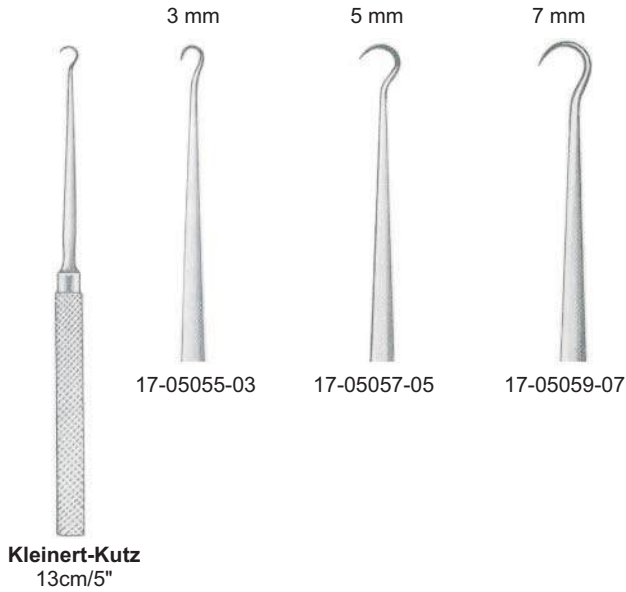

Malleable



Gil-Vernet
24cm/9½"

Malleable



24cm/9½"

12x14 mm



Little
17-05085-20
20cm/8"



Love-(Morse)
25cm/10"

- 10 mm 17-05086-10
- 15 mm 17-05086-15
- 20 mm 17-05086-20
- 30 mm 17-05086-30
- 40 mm 17-05086-40
- 50 mm 17-05086-50

08 mm 17-05080-08	17-05082-08
11 mm 17-05080-11	17-05082-11
15 mm 17-05080-15	17-05082-15
17 mm 17-05080-17	17-05082-17
20 mm 17-05080-20	17-05082-20
23 mm 17-05080-23	17-05082-23

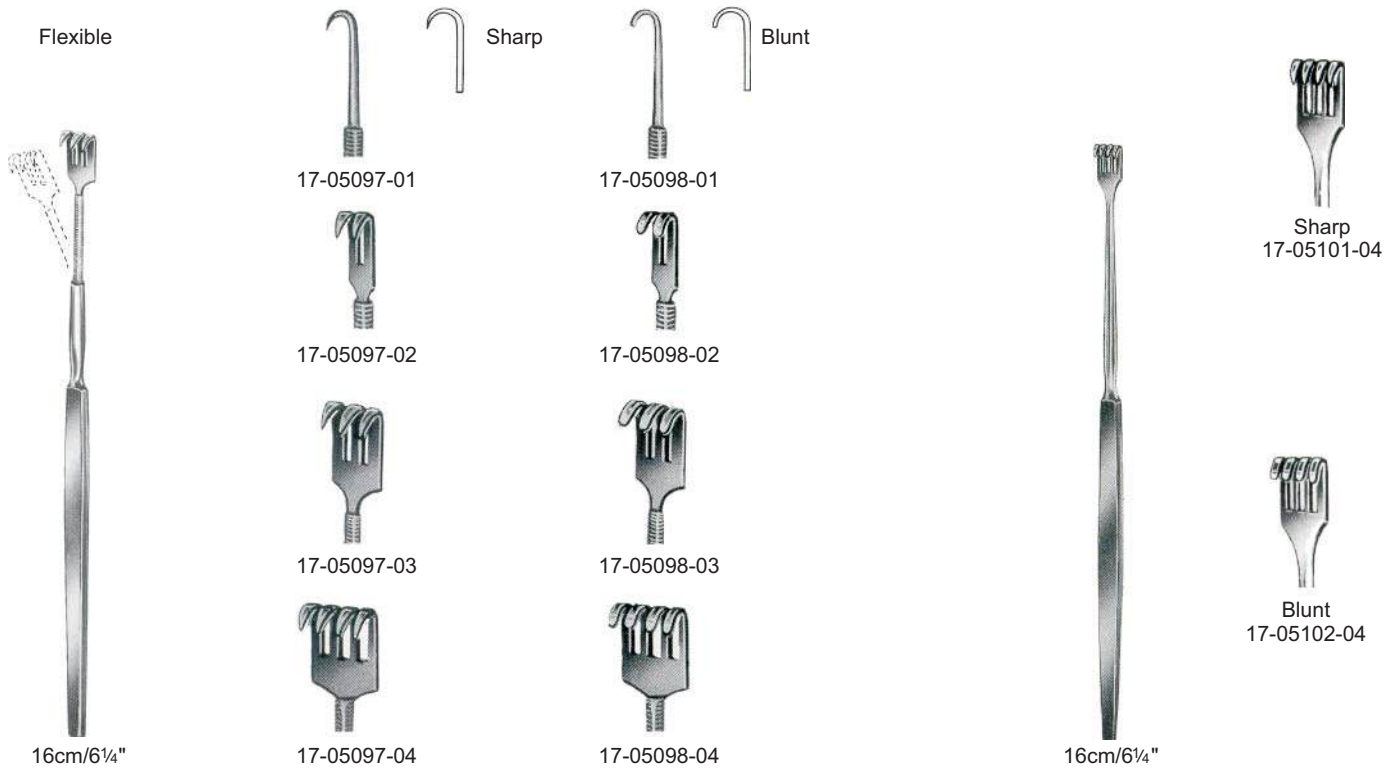
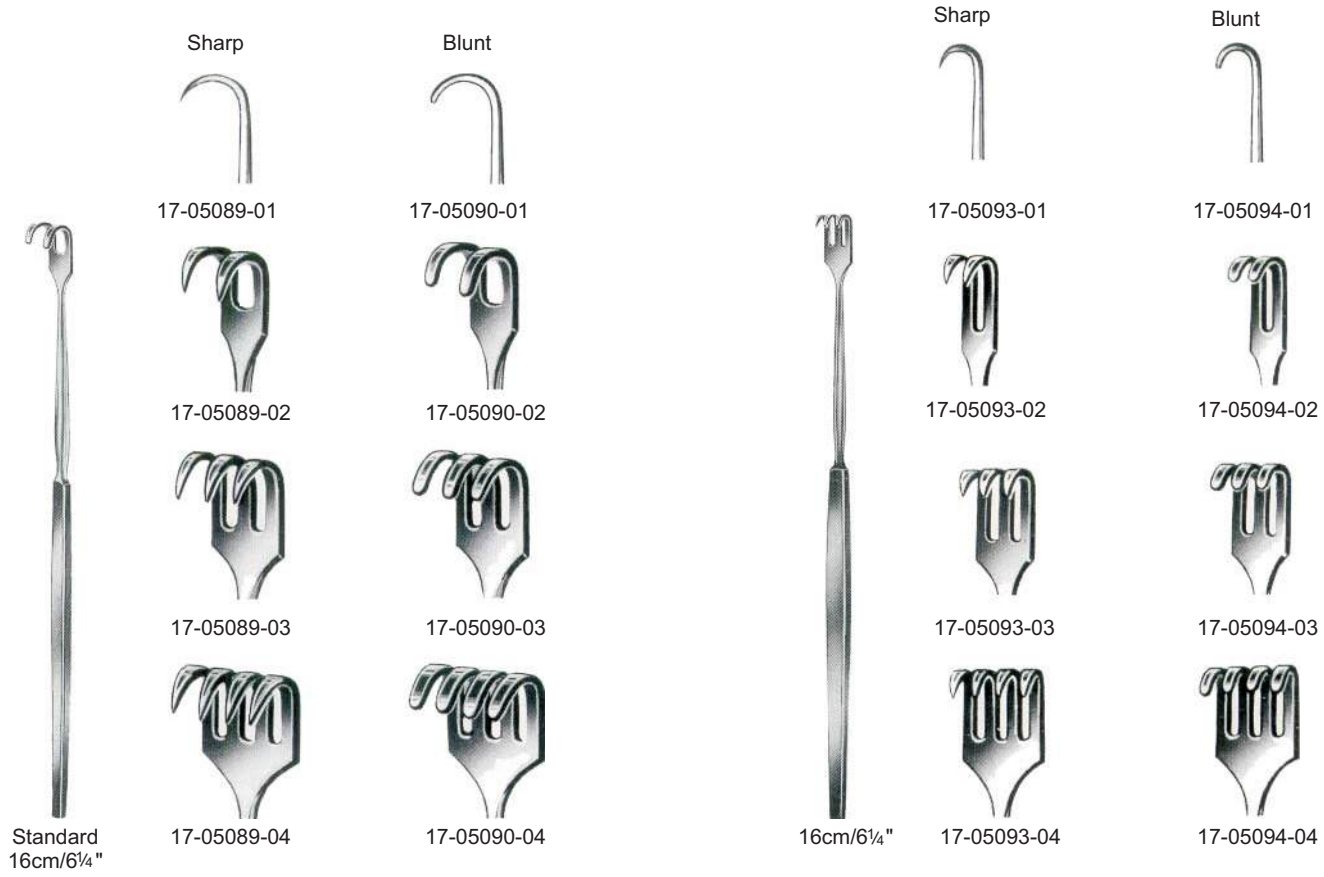



17-05106-02
13.5cm/5¼"



Jackson
17-05109-13
13cm/5"



Bergmann
17-05113-14
14cm/5½"



Iterson
16cm/6¼"



17-05117-16



17-05119-16



Meyerding
18cm/7"



17-05122-18
18x7 mm



17-05128-18
16x5 mm



17-05124-18
7x4 mm



17-05130-18
10x3 mm



17-05126-18
7x4 mm



17-05132-18



Volkmann
11.5cm/4½"



Sharp

17-05135-02



Blunt

17-05136-02



17-05135-03



17-05136-03



17-05135-04



17-05136-04



17-05135-06



17-05136-06

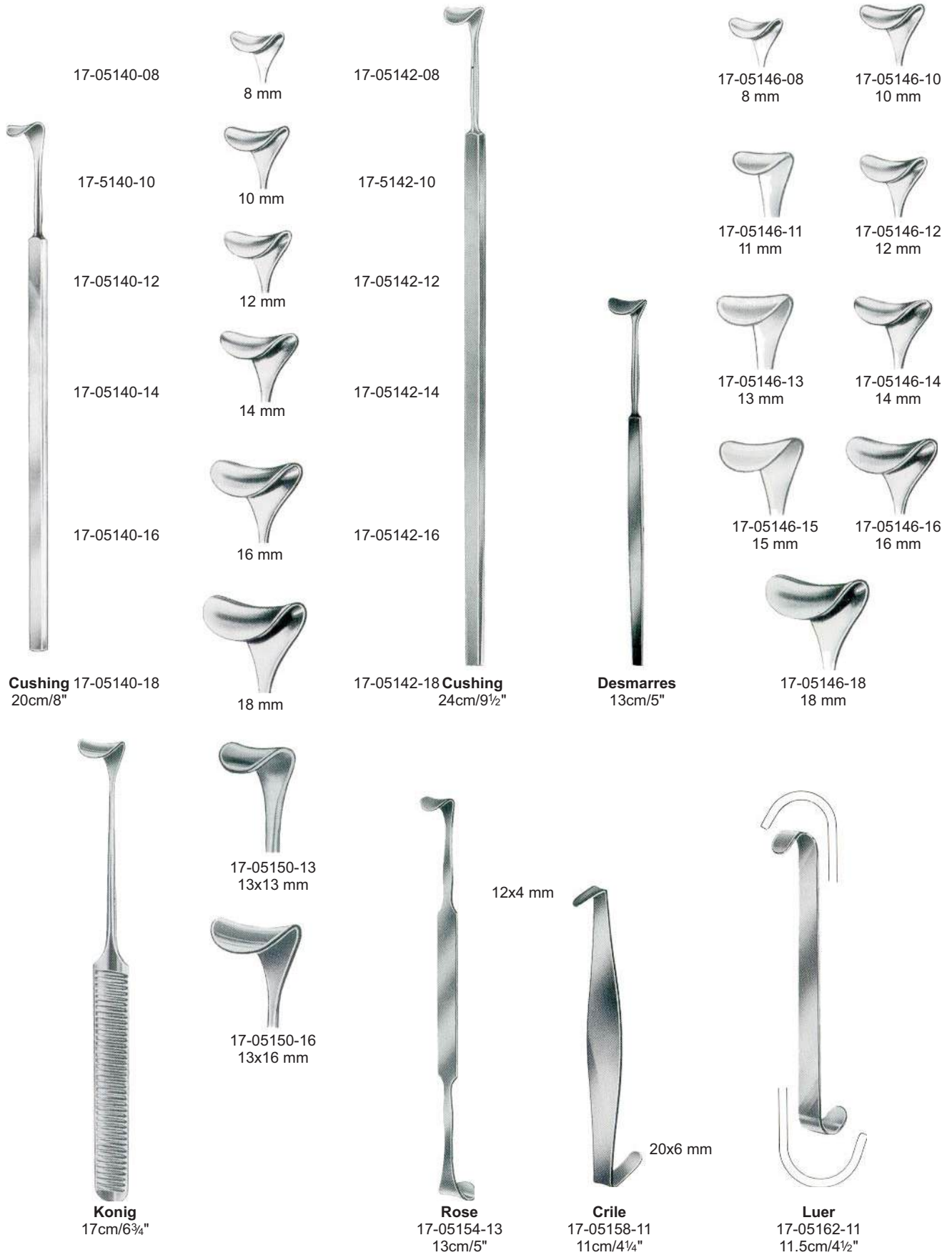

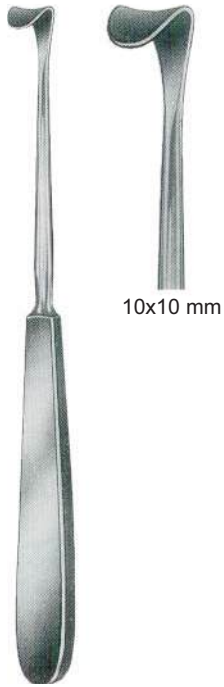

Cushing-Kocher
17-05166-18
18cm/7"



Langenbeck-Green
17cm/6¾"

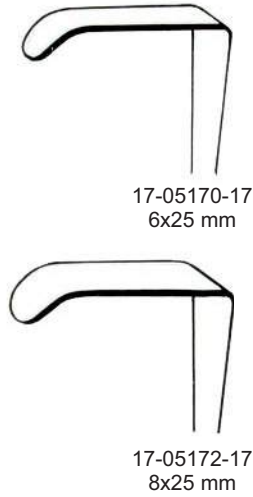

17-05170-17
6x25 mm

17-05172-17
8x25 mm



Strandell-Stille
19cm/7½"



17-05176-19



17-05178-19

Tendon Sheath Hook



17-05182-02



17-05182-03



Klapp
17.5 cm/7"



17-05182-04

Decompression Hook



Cushing
17-05186-20
20cm/8"



Senn-Miller
16cm/6¼"

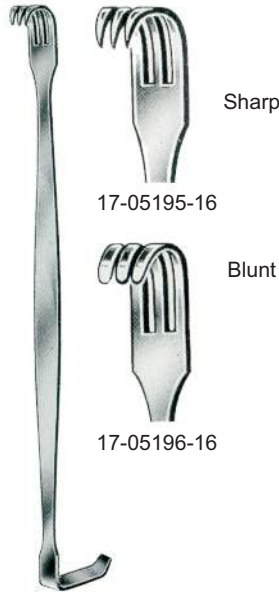

Baby-Senn-Miller
16cm/6¼"



Rangell-Davis
17-05200-14
14cm/5½"



Senn-Green
15cm/6"



Langenbeck-Green
16cm/6¼"



Collin-Hartmann

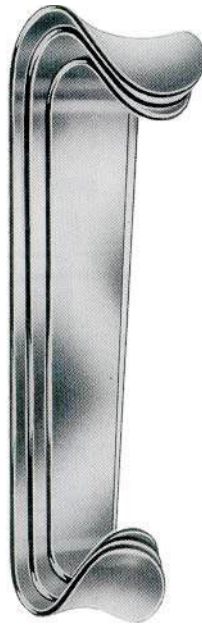

Roux



Baby-Roux
13 cm/5"



Mini-Roux
14 cm/5½"

Set	17-05214-00	Set	17-05218-00	17-05222-13	17-05224-14
14 cm/5½"	17-05214-01	14 cm/5½" Fig. 1	17-05218-01		
16 cm/6"	17-05214-02	15 cm/6" Fig. 2	17-05218-02		
		17 cm/6¾" Fig. 3	17-05218-03		

37x40 mm

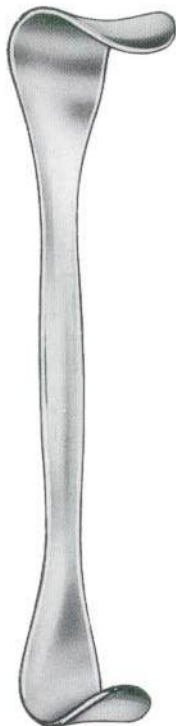

37x31 mm

Goelet
17-05228-19
19 cm/7½"



Parker-Langenbeck (US-Army)
17-05232-21
21cm/8¼"

Set



Parker
17-05236-13
13.5 cm/5¼"

Set



Parker
17-05240-18
18 cm/7"

Set



Set

Parker-Mott
17-05244-16
16 cm/6¼"



Set

Farabeuf
17-05248-12
12 cm/4¾"



Set

Farabeuf
17-05250-15
15 cm/6"



Set

Collin
17-05254-16
16.5 cm/6½"



Set

Mayo-Collin
17-05256-15
15 cm/6"



Set

Mathieu
17-05260-19
19 cm/7½"



Volkmann
17-05263-22
22 cm/8¾"



Volkmann
17-05264-22
22 cm/8¾"





















17-05267-23
23 cm/9"



17-05268-23
23 cm/9"



Volkmann
22cm/8¾"

	9x8 mm	9x13 mm	9x19 mm	9x29 mm	9x40 mm	
sharp	 17-05273-01	 17-05273-02	 17-05273-03	 17-05273-04	 17-05273-06	 17-05273-08
blunt	 17-05274-01	 17-05274-02	 17-05274-03	 17-05274-04	 17-05274-06	 17-05274-08
semi-sharp	 17-05275-01	 17-05275-02	 17-05275-03	 17-05275-04	 17-05275-06	 17-05275-08



Volkmann
23 cm/9"





sharp

blunt

semi-sharp

Kocher
21.5cm/8½"

15x10 mm

15x15 mm

15x20 mm

15x30 mm

15x40 mm



17-05295-01



17-05295-02



17-05295-03



17-05295-04



17-05295-06



17-05295-08



17-05296-01



17-05296-02



17-05296-03



17-05296-04



17-05296-06



17-05296-08



17-05297-01



17-05297-02



17-05297-03



17-05297-04



17-05297-06



17-05297-08



sharp

17-05301-20
20 cm/8"



blunt

17-05302-20
20 cm/8"



sharp

17-05305-14
14 cm/5½"



17-05308-03
36x30 mm



17-05308-04
36x60 mm

Ollier
22.5 cm/9"



Murphy
19.5 cm/7 3/4"

Sharp



17-05311-02



17-05311-03



17-05311-04



17-05311-06



blunt



17-05312-02



17-05312-03



17-05312-04



17-05312-06





Wassmund
17-05316-20
20cm/8"

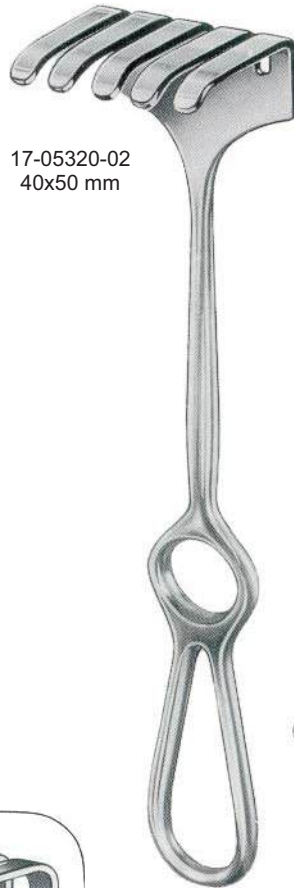

Israel
25cm/10"

17-05320-02
40x50 mm



17-05320-01
40x40 mm



17-05320-03
50x60 mm



17-05320-04
70x70 mm

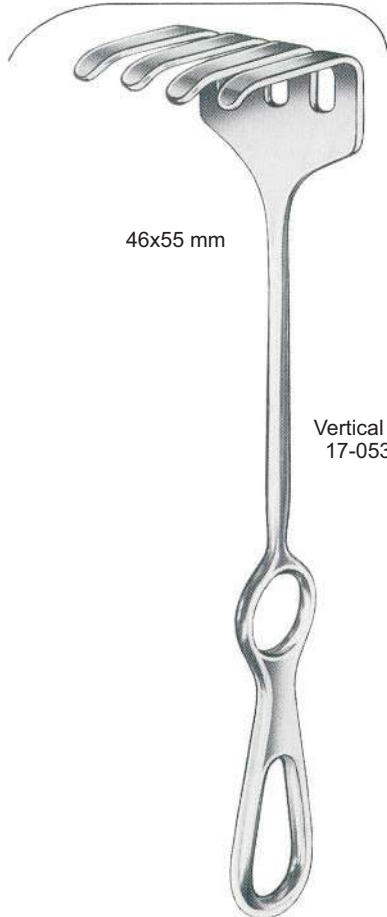

46x55 mm

Vertical Handle
17-05324-23

Koerte
23cm/9"



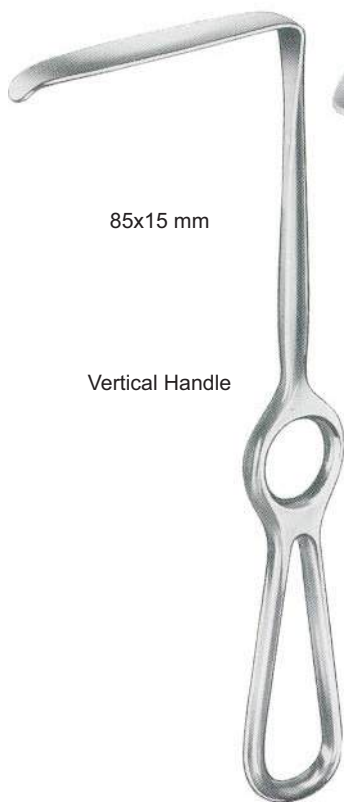

85x15 mm

Vertical Handle

Langenbeck
17-05340-21
21.5cm/8½"



17-05344-01
55x20 mm
17-05344-02
63x20 mm
17-05344-03
60x20 mm

Langenbeck
21cm/8¼"



17-05348-01
35x7 mm
17-05348-02
35x10 mm
17-05348-03
35x15 mm
17-05348-04
60x20 mm

Langenbeck
21cm/8¼"

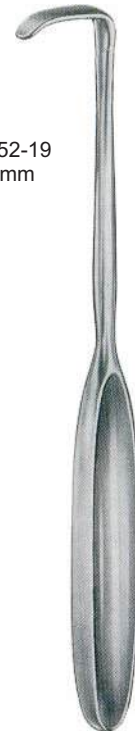

17-05352-19
28x6 mm

Lahey
19cm/7½"



23cm/9"

Sauerbruch
17-05356-01 45x15 mm
17-05356-02 55x23 mm
17-05356-03 72x20 mm



Langenbeck
21cm/8¼"

17-05360-01 30x11 mm 17-05364-01
17-05360-02 30x14 mm
17-05360-03 33x14 mm
17-05360-04 30x16 mm
17-05360-05 40x11 mm 17-05364-05
17-05360-06 42x13 mm 17-05364-06
17-05360-07 50x11 mm



Langenbeck
22cm/8¾"



38x20 mm

Kocher
17-05368-22
22cm/8¾"

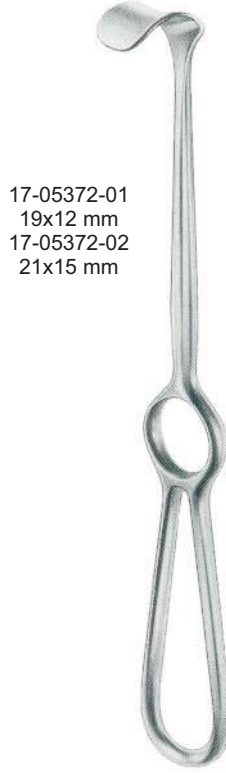

17-05372-01
19x12 mm
17-05372-02
21x15 mm

Kocher
19cm/7½"

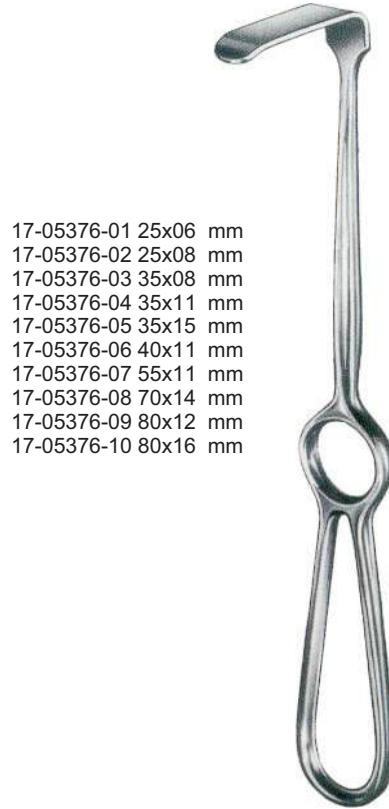

17-05376-01 25x06 mm
17-05376-02 25x08 mm
17-05376-03 35x08 mm
17-05376-04 35x11 mm
17-05376-05 35x15 mm
17-05376-06 40x11 mm
17-05376-07 55x11 mm
17-05376-08 70x14 mm
17-05376-09 80x12 mm
17-05376-10 80x16 mm

Kocher-Langenbeck
21.5cm/8½"



67x17cm

Casper
17-05380-21
21.5cm/8½"

17-05388-01
22x15 mm



17-05388-02
38x20 mm

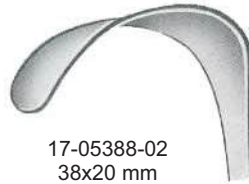

17-05388-03
67x25 mm



17-05388-04
100x35 mm

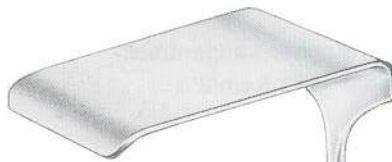

17-05384-01
40x18 mm
17-05384-02
60x20 mm
17-05384-03
60x25 mm
17-05384-04
75x30 mm
17-05384-05
75x40 mm

Kocher
23cm/9"



Kocher-Wagner
28cm/11"



17-05392-01
60x20 mm
17-05392-02
80x30 mm
17-05392-03
100x30 mm
17-05392-04
120x30 mm
17-05392-05
140x30 mm
17-05392-06
140x40 mm

Heosel
25cm/10"





130x60 mm

St. Marks
17-05396-29
29cm/11½"

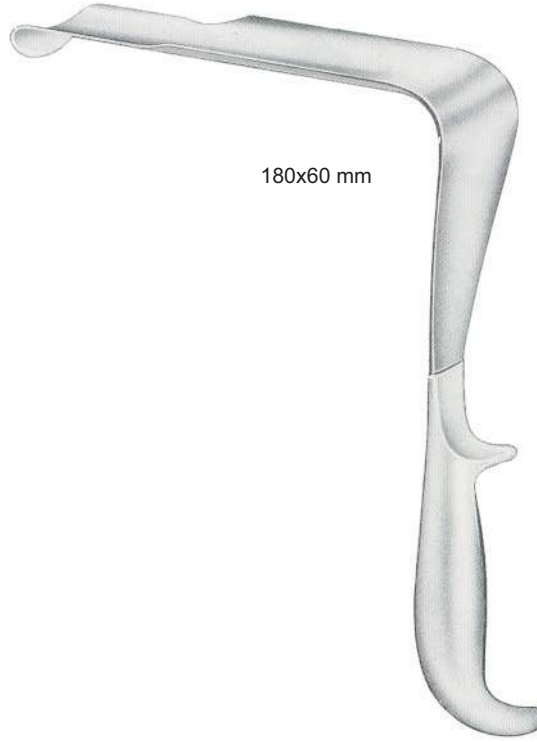

180x60 mm

St. Marks
17-05396-32
32.5cm/12¾"

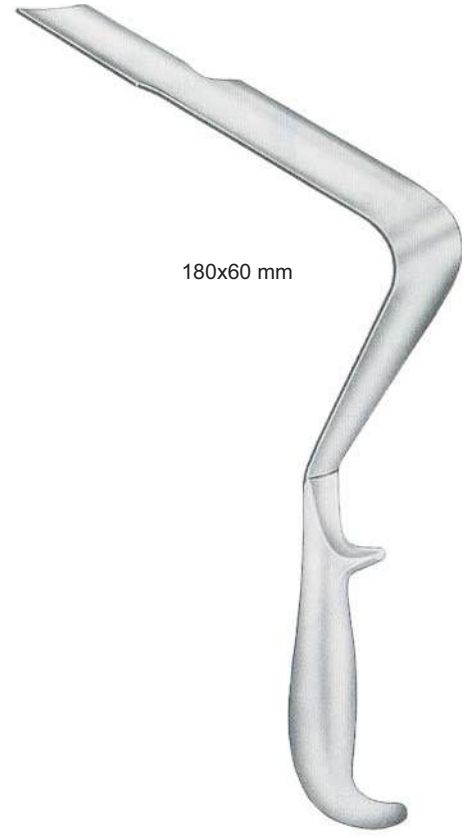

180x60 mm

St. Marks
17-05396-33
33cm/13"



17-05400-01
70x40 mm
17-05400-02
70x50 mm
17-05400-03
70x65 mm

Morris
21cm/8¼"



17-05402-01
32x50 mm/38x50mm
17-05402-02
45x50 mm/50x50mm
17-05402-03
65x50 mm/38x50mm

Morris
24cm/9½"

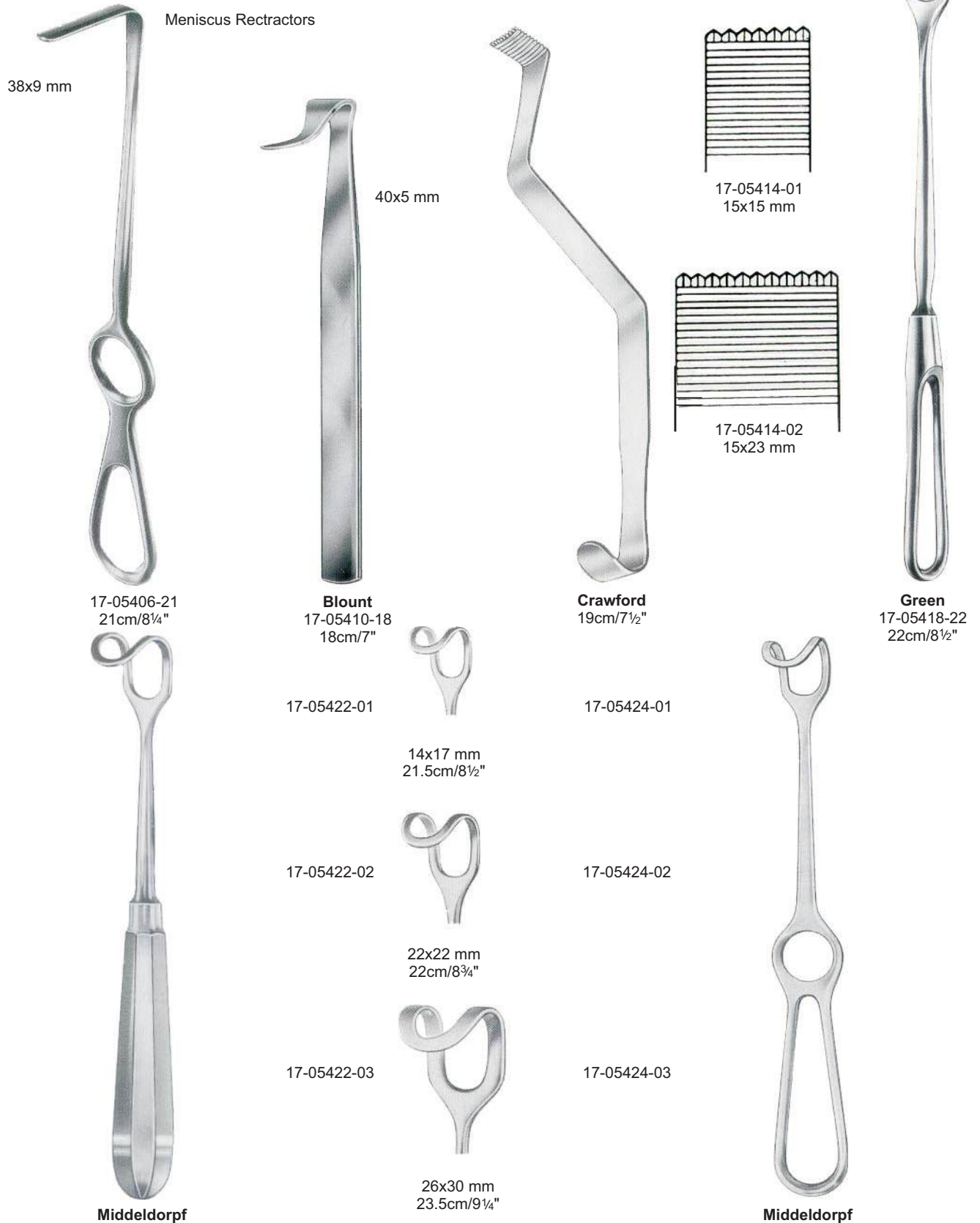

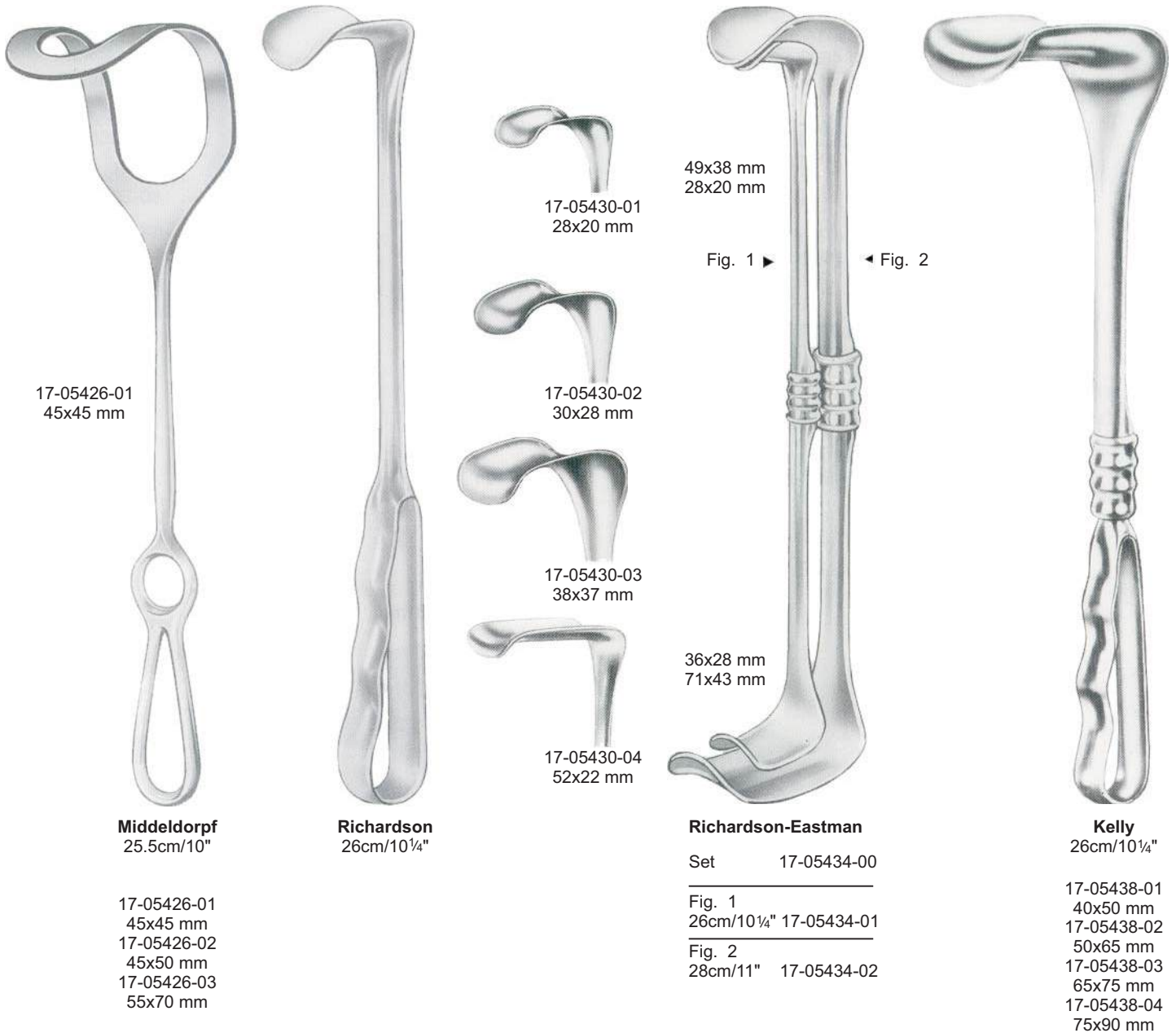

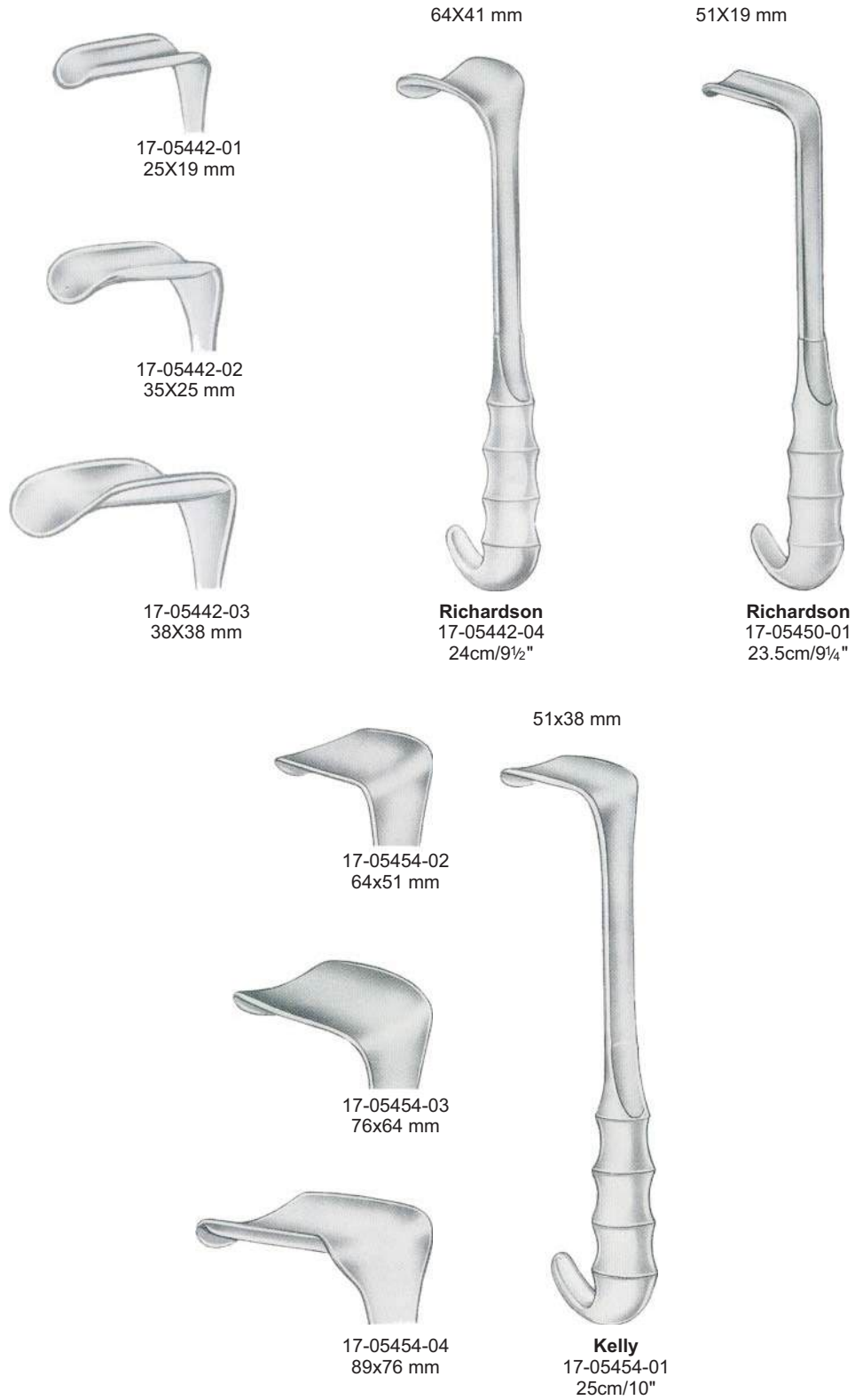



17-05458-01
45x40 mm
17-05458-02
45x50 mm
17-05458-03
45x60 mm
17-05458-04
45x75 mm
17-05458-05
65x85 mm

Fritsch
24cm/9½"

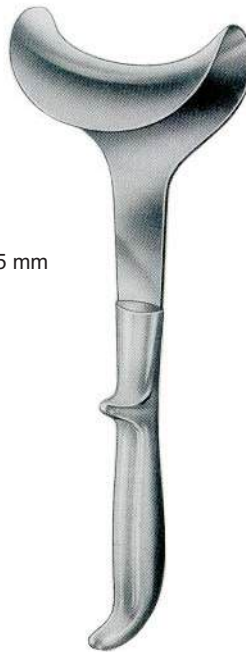

50x85 mm

Doyen
17-05462-25
25cm/10"

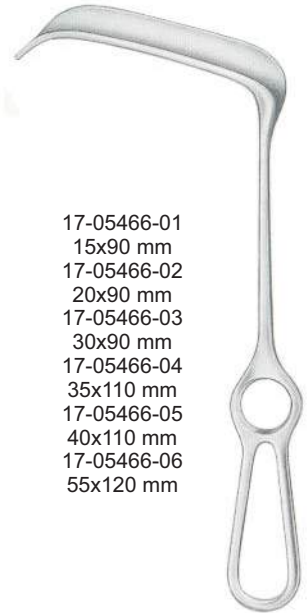

17-05466-01
15x90 mm
17-05466-02
20x90 mm
17-05466-03
30x90 mm
17-05466-04
35x110 mm
17-05466-05
40x110 mm
17-05466-06
55x120 mm

Doyen-Stille
24cm/9½"



70x25 mm

Kocher
17-05470-22
22.5cm/9"

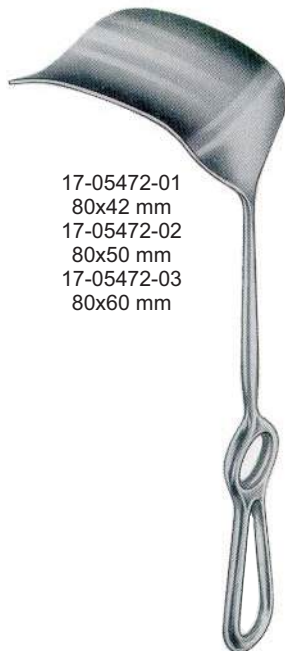

17-05472-01
80x42 mm
17-05472-02
80x50 mm
17-05472-03
80x60 mm

Kocher
25cm/10"



60x60 mm

Tuffier
17-05476-23
23cm/9"

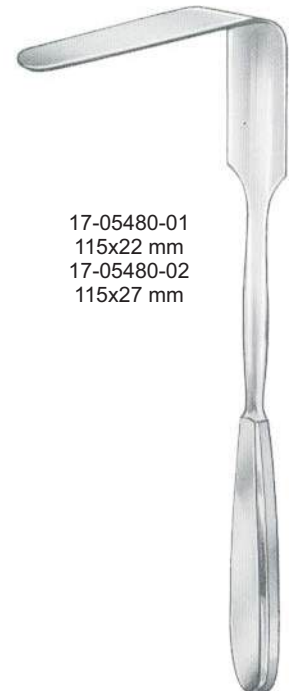

17-05480-01
115x22 mm
17-05480-02
115x27 mm

Simon
28cm/11"

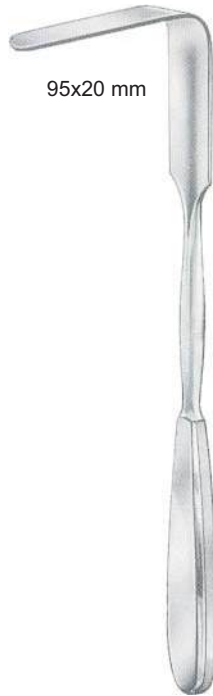

95x20 mm

Tuebingen
17-05484-28
28cm/11"



105x27 mm

Martin
17-05488-26
26cm/10¼"

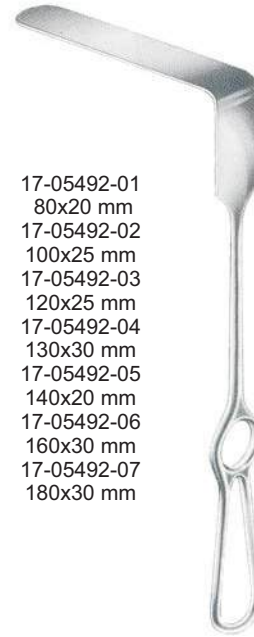

17-05492-01
80x20 mm
17-05492-02
100x25 mm
17-05492-03
120x25 mm
17-05492-04
130x30 mm
17-05492-05
140x20 mm
17-05492-06
160x30 mm
17-05492-07
180x30 mm

Brunner
25cm/10"

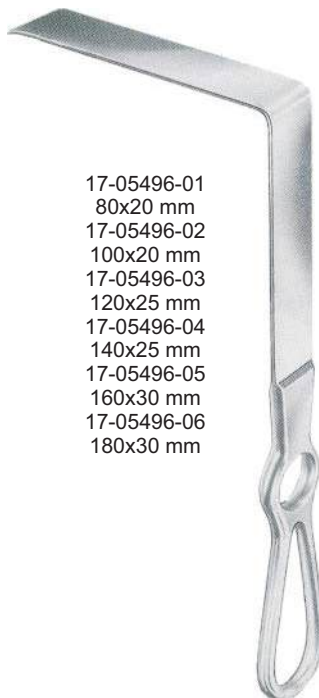

17-05496-01
80x20 mm
17-05496-02
100x20 mm
17-05496-03
120x25 mm
17-05496-04
140x25 mm
17-05496-05
160x30 mm
17-05496-06
180x30 mm

Brunner
25cm/10"



17-05500-01
85x35 mm
17-05500-02
120x50 mm
17-05500-03
155x50 mm

Mikulicz
26cm/10¼"



90x50 mm

Mikulicz
17-05502-26
26cm/10¼"



17-05506-01
160x38 mm
17-05506-02
160x57 mm
17-05508-01
190x38 mm
17-05508-02
190x57 mm

Kelly
27cm/10½"



Polloson
17-05510-27
27cm/10½"



Polloson
17-05512-27
27cm/10½"



17-05516-03
115x65 mm

17-05516-02
115x38 mm

17-05516-01
82x20 mm

Coryllos
23.0cm/9"

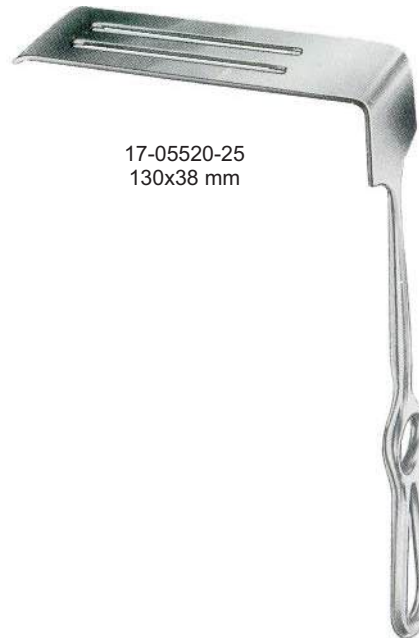

17-05520-25
130x38 mm

Sauerbruch
25cm/10"





17-05536-01
50x16 mm
17-05536-02
75x25 mm
17-05536-03
90x50 mm

Meyerding
22.5cm/9"



Zenker

17-05540-01 25cm/10" 35x08 mm
17-05540-02 26cm10¼" 60x12 mm
17-05540-03 27.5cm/10¾" 75x12 mm



17-05544-00
Set of 2
Fig. 1
17-05544-01
25x75 mm
Fig. 2
17-05544-02
25x80 mm

Hibbs
24cm/9½"



17-05548-01
45x25 mm
17-05548-02
73x28 mm
17-05548-03
82x28 mm

Heaney
27cm/10½"

46 mm



Kuemmel
17-05552-33
33cm/13"

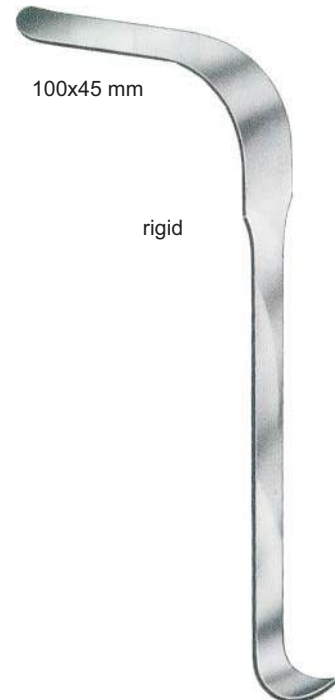

100x45 mm

rigid

Koerte
17-05556-28
28cm/11"

17-05560-20
20 mm
17-05560-30
30mm
17-05560-40
40 mm



Kader
27cm/10½"



17-05564-01
25.5cm/10"
45 mm
17-05564-02
27.5cm/10¾"
60 mm

Leriche



Malleable
17-05568-01 20 mm
17-05568-02 25 mm
17-05568-03 30 mm
17-05568-04 35 mm
17-05568-05 40 mm
17-05568-06 45 mm
17-05568-07 50 mm
17-05568-08 64 mm
17-05568-09 76 mm
17-05568-10 102 mm
33cm/13"

Malleable



Tuffier
17-05570-20
20 cm/8"
17x25 mm

Malleable

17-05572-01
200x6 mm
17-05572-02
200x8 mm
17-05572-03
200x10 mm
17-05572-04
200x12 mm
17-05572-05
200x17 mm
17-05572-06
200x20 mm
17-05572-07
200x25 mm
17-05572-08
250x25 mm



20cm/8"

Malleable

17-05574-01
280x25/30 mm
17-05574-02
300x37/45 mm
17-05574-03
300x40/50 mm



Haberer
21cm/8¼"



Reverdin
17-05578-28
28 cm/11"



Davidson
16cm/6¼"

75x50 mm 17-05582-01
75x90 mm 17-05582-02



Cooley
17-05586-01
21.5cm/8½"

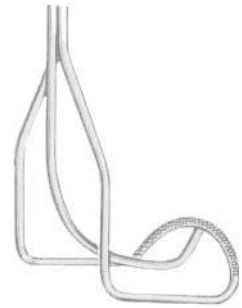

Cooley
17-05586-02
21.5cm/8½"



Cooley
17-05586-03
23cm/9"



Ross
27cm/10½"

- Fig. 1 17-05590-01 13x13 mm
- Fig. 2 17-05590-02 14x12 mm
- Fig. 3 17-05590-03 18x18 mm
- Fig. 4 17-05590-04 20x20 mm
- Fig. 5 17-05590-05 22x18 mm
- Fig. 6 17-05590-06 26x24 mm

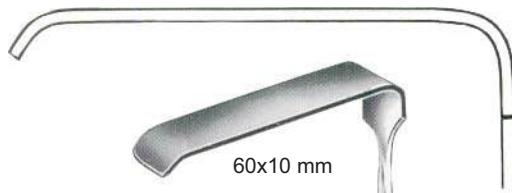

60x10 mm



Kirsch
17-05594-01
20cm/8"

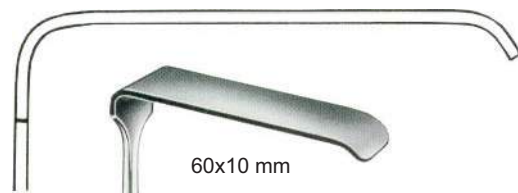

60x10 mm



Kirsch
17-05594-02
20cm/8"



Set
17-05600-00

17-05600-01
24.5cm/10"

17-05600-02
24.5cm/10"



17-05604-01
40x12 mm

17-05604-02
55x14 mm

Dockhorn
20cm/8"



22cm/8³/₄"



17-05608-01
25x7 mm



17-05608-02
31x10 mm



17-05608-03
42x11 mm



17-05608-04
55x12 mm



17-05608-05
70x14 mm

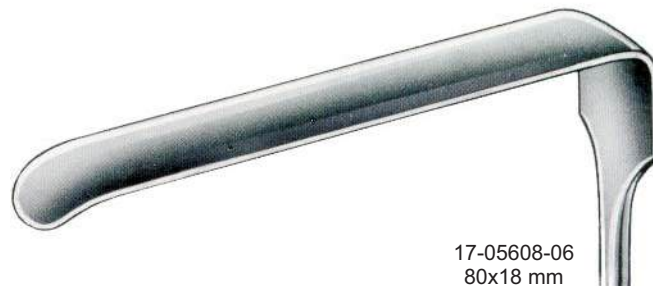

17-05608-06
80x18 mm



22cm/8 $\frac{3}{4}$ "



17-05612-01
42x13 mm



17-05612-02
60x12 mm



17-05612-03
80x16 mm



Spina-Nasalis
17-05616-01
22 cm/8¾"

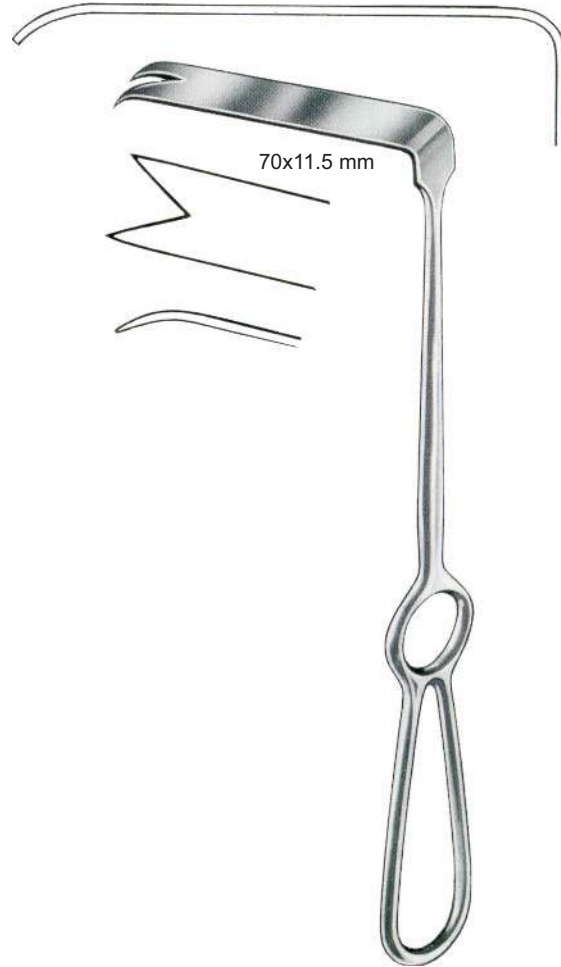

Ramus
17-05616-02
22 cm/8¾"



17-05620-15
15.5 cm/6"



17-05624-16
16 cm/6¼"

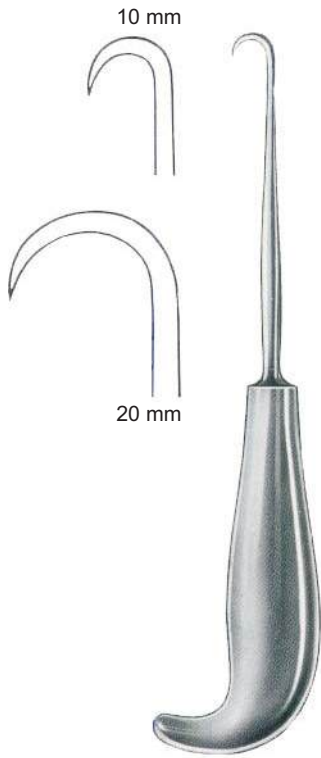

17-05627-10 10 mm
17-05627-20 20 mm
19cm/7½"



Dingman
17-05629-17
17.5cm/7"



Soeresen-Hein
17-05632-17
17.5cm/7"



Dingman
17-05636-21
21cm/8¼"



17-05640-18
18.5cm/7¼"

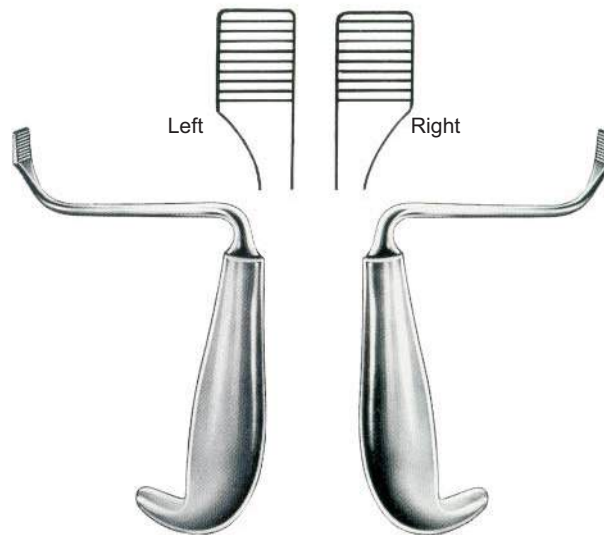

Tessier
17-05644-01
15cm/6"

Tessier
17-05646-02
15cm/6"



Dingman
17-05648-00



17-05652-21
21cm/8¼"



17-05658-20
20.5cm/8"



17-05662-17
17.5cm/7"



17-05668-05
5 mm



17-05668-07
7 mm



17-05668-09
9 mm



20cm/8"



17.5cm/7"



17-05672-06
6 mm



17-05672-07
7 mm



17-05672-09
9 mm



17-05672-11
11 mm

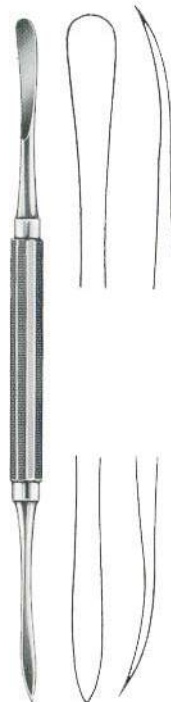

Dingman
17-05676-18
18cm/7"



17-05680-23
23.5cm/9¼"
10 mm

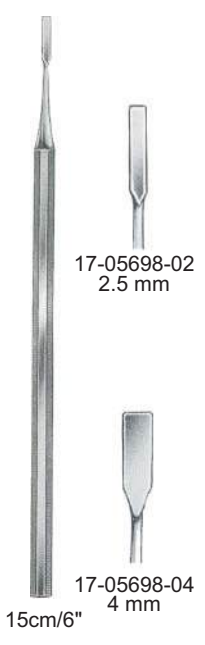
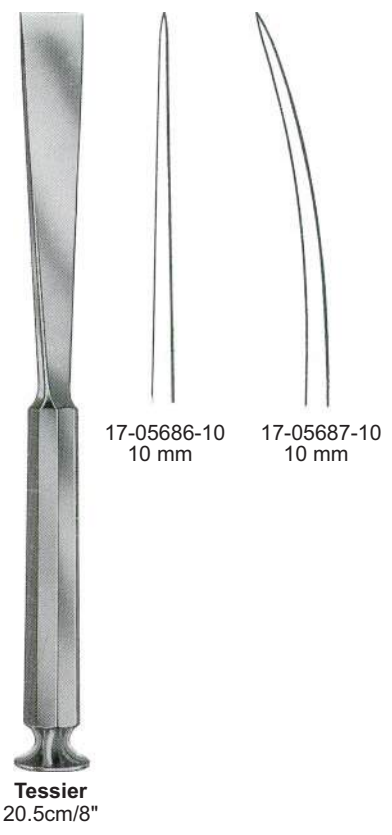

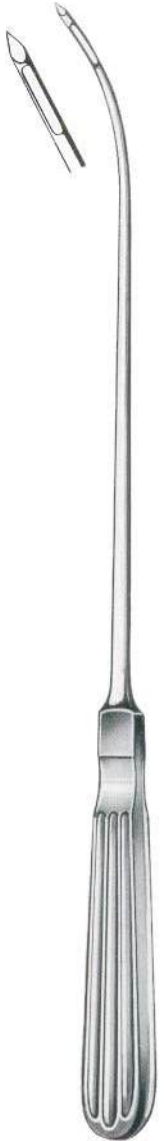

Sanders-Brown
17-05712-30
30cm/12"



Sanders-Brown
17-05716-29
29cm/11½"



17-05720-14
14cm/5½"



17-05722-23
23cm/9"



17-05724-18
18cm/7"



Kelsey-Fry
17-05726-15
15cm/6"



Kelsey-Fry
17-05728-18
18cm/7"



Mershon
17-05732-14
14.5cm/5½"



Bose



Finsen



Finsen

Sharp

Blunt

Sharp

cm	in				
5	2		17-05739-05		17-05740-05
7	2¾"	17-05736-07	17-05739-07	17-05740-07	17-05743-07



Allport
17-05750-09
9.5cm/3¾"

Sharp



Alm

Blunt

cm	in		cm	in		
8.5	3½"	17-05746-08	7	2¾"	17-05753-07	17-05756-07
11.5	4½"	17-05746-11	10	4	17-05753-10	17-05756-10



Holzheimer
Sharp 17-05759-10 10 cm/4"
blunt 17-05760-10



Jansen
Sharp 17-05763-10 10.5 cm/4 1/4"
blunt 17-05764-10



Jansen-Deep
Sharp 17-05767-10 10.5 cm/4 1/4"
blunt 17-05768-10



Plester
17-05772-11
11.5 cm/4 1/2"



Plester
17-05774-11
11.5 cm/4 1/2"



Plester
Sharp 17-05777-13 13 cm/5"
blunt 17-05778-13

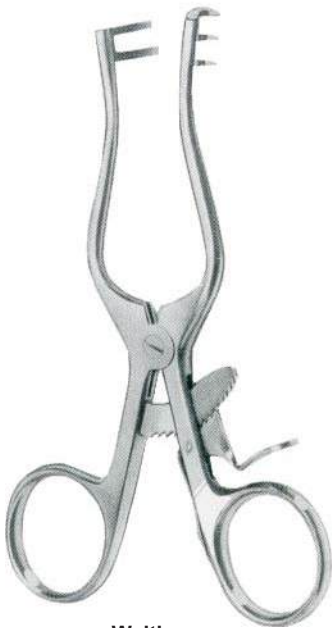

Weitlaner

Sharp

Blunt



Weitlaner

Sharp

Blunt



Weitlaner-Wullstein

Sharp

Blunt

10.5 cm/4¼"	17-05781-10	17-05782-10				
13.0 cm/5"	17-05781-13	17-05782-13	17-05785-13	17-05786-13	17-05789-13	17-05790-13
14.0 cm/5½"	17-05781-14	17-05782-14	17-05785-14	17-05786-14	17-05789-14	17-05790-14
16.5 cm/6½"	17-05781-16	17-05782-16	17-05785-16	17-05786-16	17-05789-16	17-05790-16



Mollison
17-05793-15
15 cm/6"

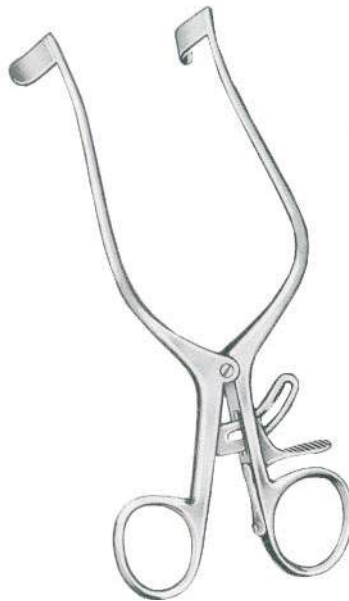

Tuebinger-Modell
17-05796-16
16 cm/6¼"

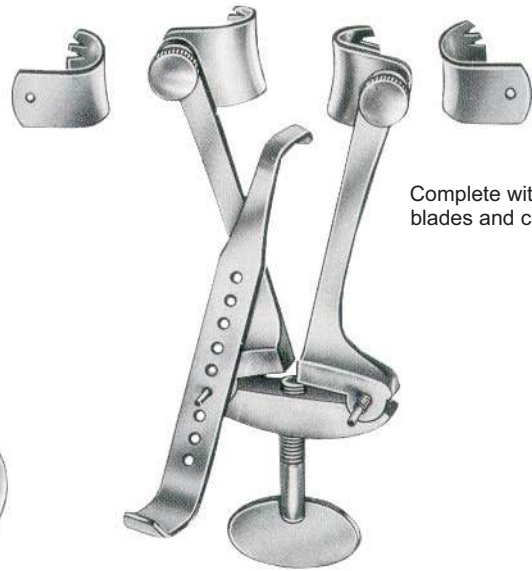

Henner(Lempert)
17-05800-12
12 cm/4½"

Complete with 2 pairs of blades and centre blade

Complete with 3 Central blades

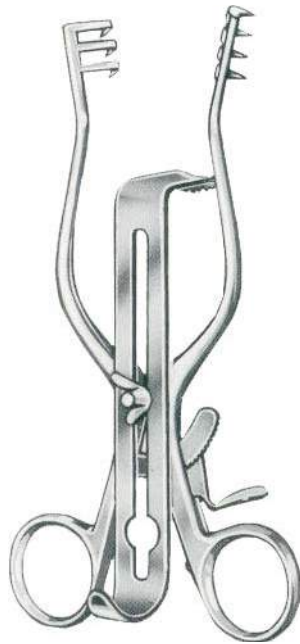

Henley

Sharp		Blunt
17-05803-16	16.5 cm/6½"	17-05804-16

Central blades, only



17-05805-19	17-05805-25	17-05805-32
16x19 mm	16x25 mm	16x32 mm



Weitlaner-Baby

13 cm/5"	17-05808-13
16 cm/6¼"	



Milligan

Sharp	Blunt
17-05811-13	17-05812-13



Cone (Adson-Baby)

Sharp	Blunt
17-05815-13	17-05816-13
17-05815-16	17-05816-16



Weitlaner

	Sharp	Blunt	Sharp	Blunt
20 cm/8"	17-05819-20	17-05820-20	17-05821-25	17-05822-25
25 cm/10"	17-05819-25	17-05820-25		



3x4 Teeth



5x6 Teeth



Adson

	Sharp	Blunt
20 cm/8"	17-05823-20	17-05824-20
26 cm/10¼"	17-05823-26	17-05824-26



Anderson-Adson

	Sharp	Blunt
20 cm/8"	17-05827-20	17-05828-20



Cone

	Sharp	Blunt
20 cm/8"	17-05831-20	17-05832-20
26 cm/10¼"	17-05831-26	17-05832-26

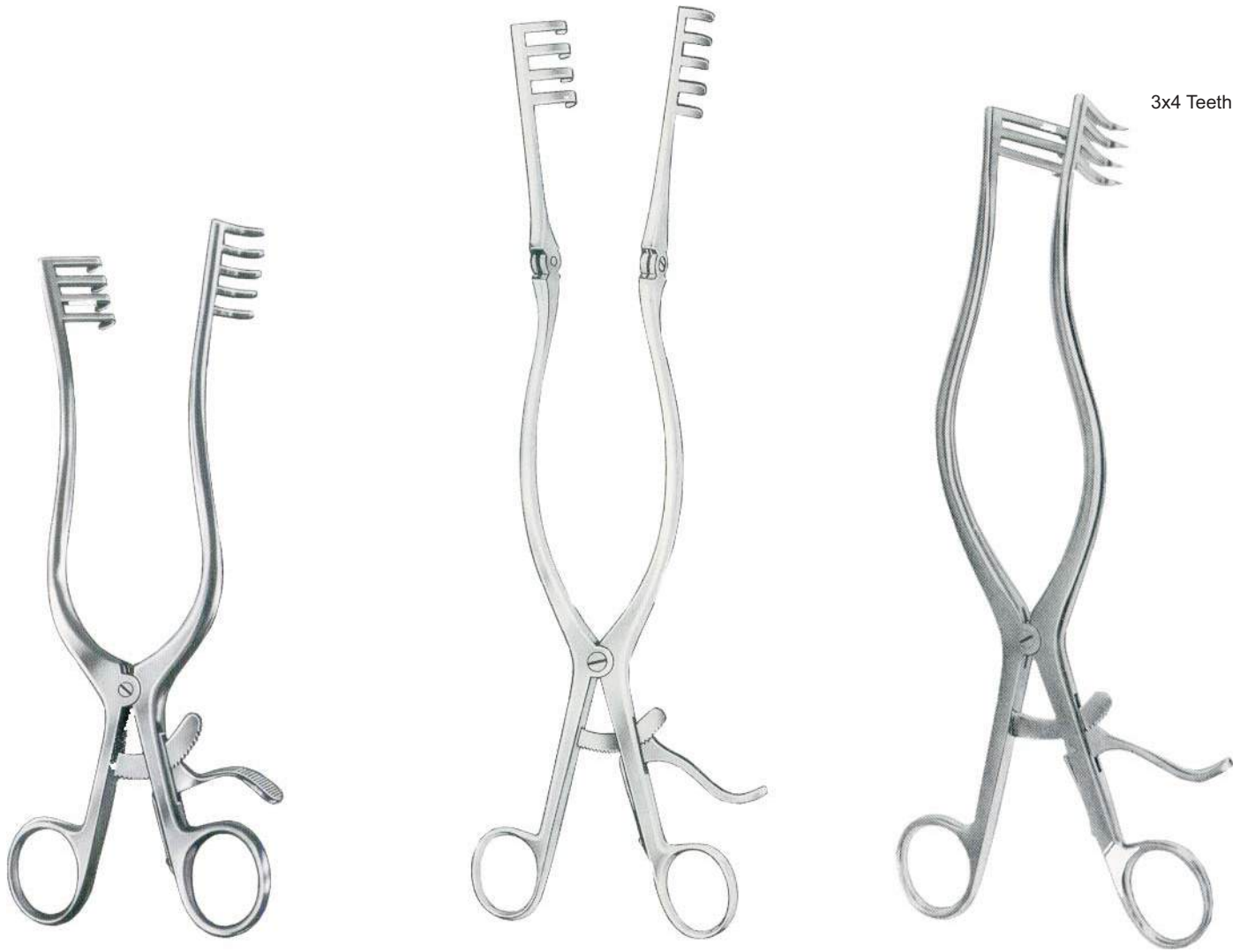

Travers
17-05836-21
21 cm/8¼"

Jaws Depth

25 mm
44 mm

Beckmann-Adson
31 cm/12¼"

Sharp	Blunt
17-05839-01	17-05840-01
17-05839-02	17-05840-02

Adson
27 cm/10½"

Sharp	Blunt
17-05843-27	17-05844-27

5x6 Teeth



Adson

Sharp 17-05847-27 27cm/10½"
Blunt 17-05848-27



**Beckmann-Adson
(Standard)**

Sharp 17-05851-31 31cm/12¼"
Blunt 17-05852-31



Adson

17-05856-33
33cm/13"

Hemilaminectomy Retractor



17-05861-27
27cm/10½"



Beckmann-Eaton
17-05864-33
33 cm/13"

Retractor Only 17-05868-01
Lateral Blades 17-05868-02



Collin
17-05868-00
20cm/8"

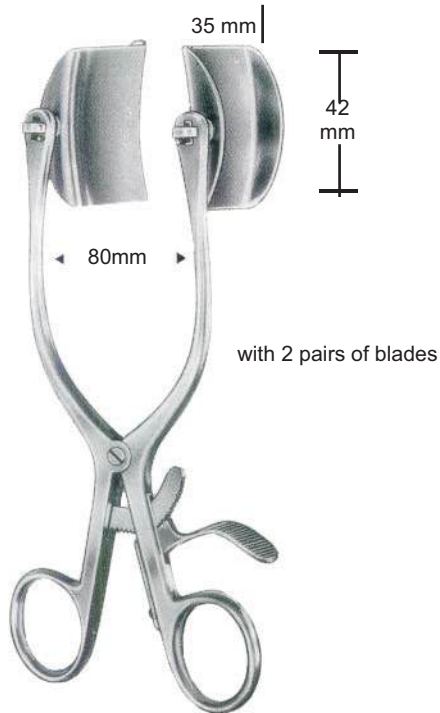

Baby-Collin
17-05872-00

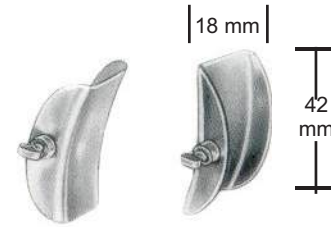

17-05872-01



Collin
20 cm/8"

	Fig. 1	Fig. 2	Fig. 3
Retractors Complete	17-05876-00	17-05878-00	17-05880-00
Retractors Only	17-05876-01	17-05878-01	17-05880-01
Lateral Blades	17-05876-02 38x62 mm	17-05878-02 38x80 mm	17-05880-02 38x100 mm
Central Blades	17-05876-03 55x55 mm		17-05880-03 55x75 mm

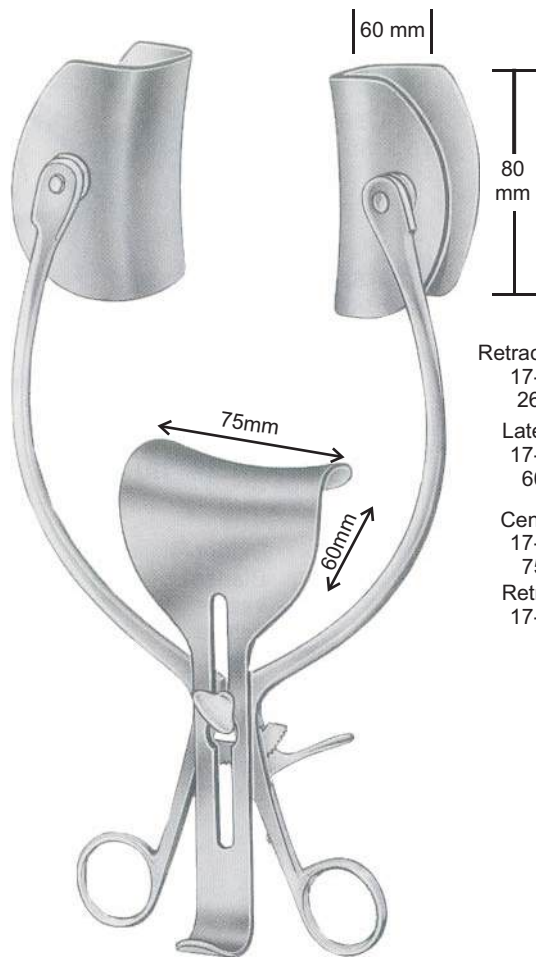

Collin

Retractor Complete
17-05884-00
26cm/10½"
Lateral Blades
17-05884-01
60X80mm
Central Blades
17-05884-02
75X60mm
Retractor Only
17-05884-03



Mayo-Adams
17-05886-01
17cm/6¾"

Mayo-Adams
17-05886-02
17cm/6¾"

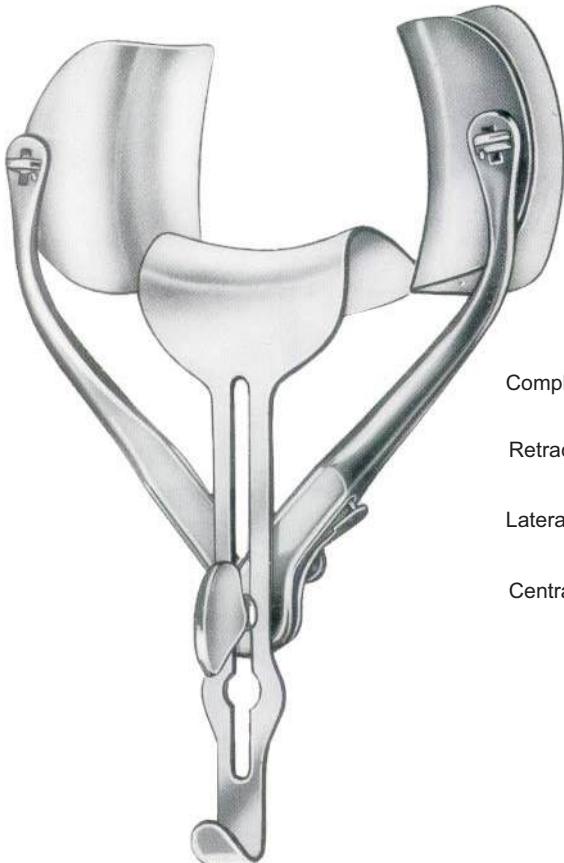

Ricard
17-05890-00 28cm/11"
17-05894-00 30cm/12"

	Fig. 1	Fig. 2
Complete	17-05890-00	17-05894-00
Retractors Only	17-05890-01	17-05894-01
Lateral Blades	17-05890-02 60x80 mm	17-05894-02 75x85 mm
Central Only	17-05890-03 53x70 mm	17-05894-03 80x90 mm

Vulval Retractor



Richter
17-05898-16
16.5 cm/6½"



Gelpi
17-05902-09 9 cm/3½"
17-05902-11 11 cm/4½"
17-05902-13 13 cm/5"
17-05902-19 19 cm/7½"



Gelpi
17-05904-19
19 cm/7½"



Meyerding
Fig. 1 17-05908-01
Fig. 2 17-05908-02
Fig. 3 17-05908-03
Fig. 4 17-05908-04
18 cm/7"

Blades

- Fig. 1 1¼"x1"
- Fig. 2 2⅛"x1"
- Fig. 3 2⅜"x1¼"
- Fig. 4 2⅜"x1"



Markham-Meyering

17-05912-18 18cm/7" 17-05914-18

Rigby

17-05918-19
19cm/7½"

De Bakey

17-05922-12 12cm/4¾"
17-05922-17 17cm/6¾"

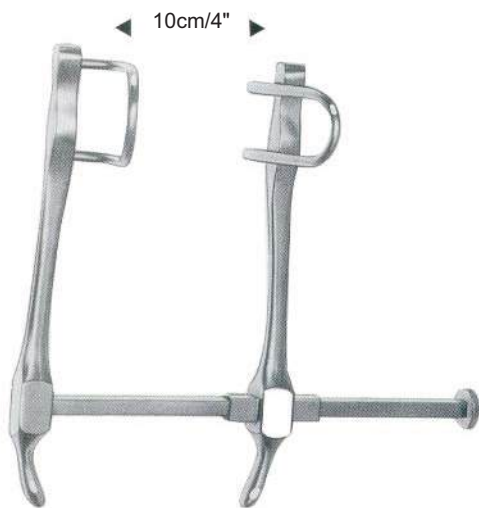

Gosset
17-05926-00

Fig.1 ◀ 10cm/4" ▶
Fig.2 ◀ 14cm/5½" ▶



Gosset
Fig.1 17-05928-01
Fig.2 17-05928-02



Gosset
17-05932-00

Retractors Only
17-05932-01

Central Blade
17-05932-02
56X60mm

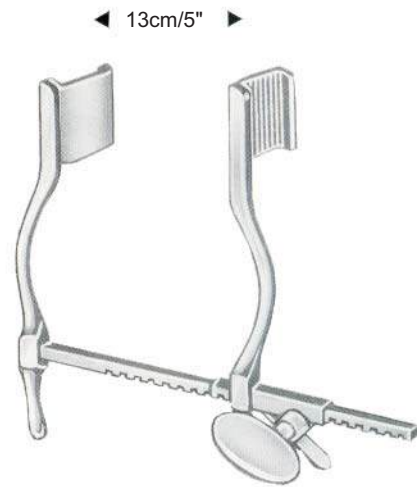

Hertzler
17-05936-00

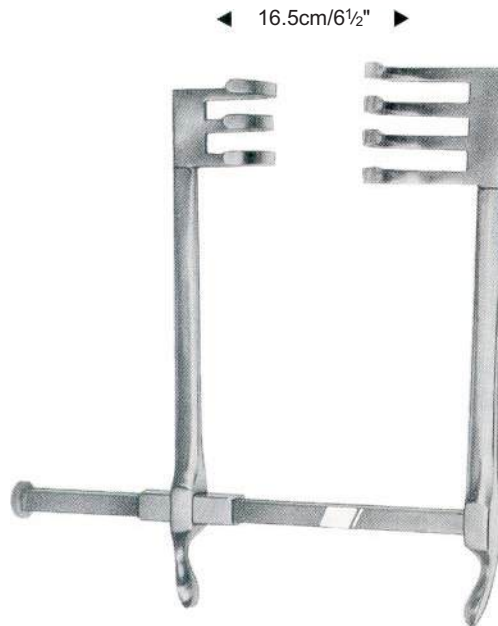

Frazier
17-05940-00

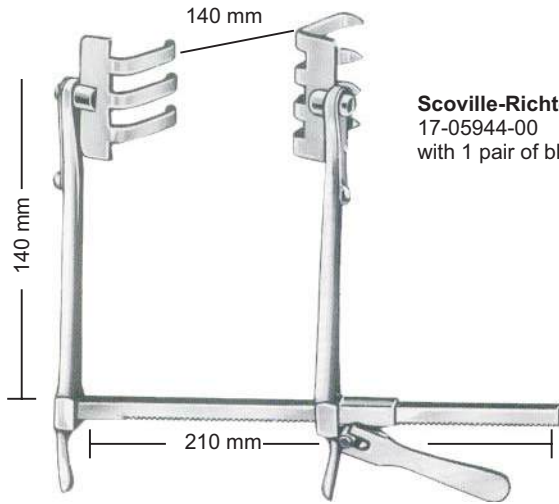

Scoville-Richter
17-05944-00
with 1 pair of blades 17-05944-01

the blades are available by pairs



17-05944-01
60x50 mm

17-05944-02
48x50 mm



17-05944-03
28x40 mm



17-05944-04
38x62 mm

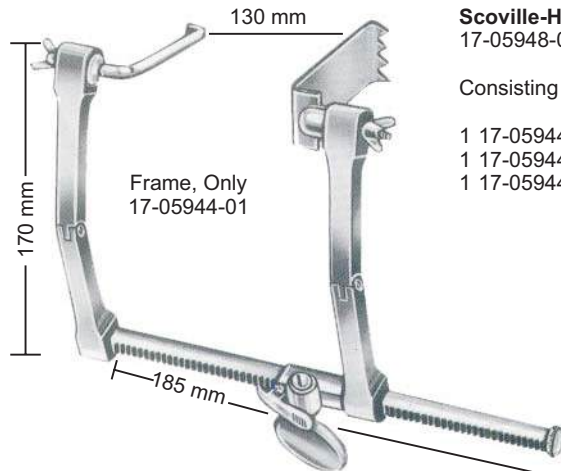

Frame, Only
17-05944-01

Scoville-Haverfield
17-05948-00

Consisting of:

- 1 17-05944-01
- 1 17-05944-02
- 1 17-05944-03



Scoville
17-05948-02
51 mm



Scoville
17-05948-03 63x25 mm
17-05948-04 63x51 mm
17-05948-05 67x32 mm
17-05948-06 89x25 mm



Taylor
17-05948-07
48x38 mm



Taylor
17-05948-08 63x51 mm
17-05948-09 79x57 mm

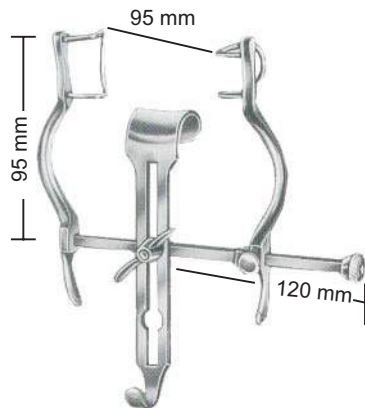

Baby-Balfour
17-05952-00

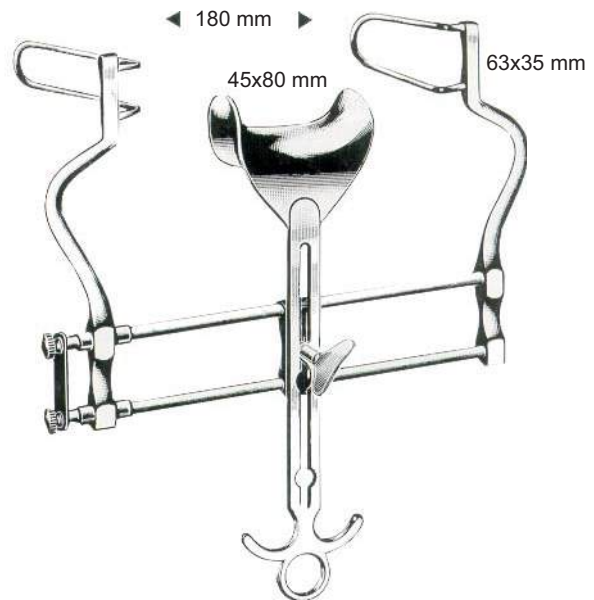

Balfour
17-05956-00

Retractor Complete

Retractor Only

Central Blade Only

17-05952-01

17-05952-02

17-05956-01

17-05956-02



Retractor Complete
17-05960-00

Retractor Only
17-05960-01

Central Blade Only
17-05960-02

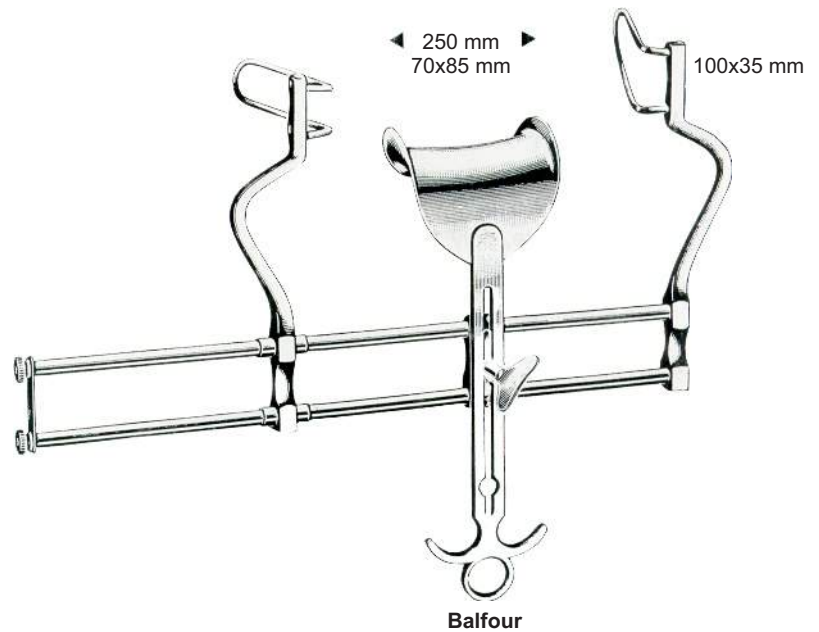

Retractor, Complete
17-05964-00

Retractor Only
17-05964-01

Central Blade Only
17-05964-02

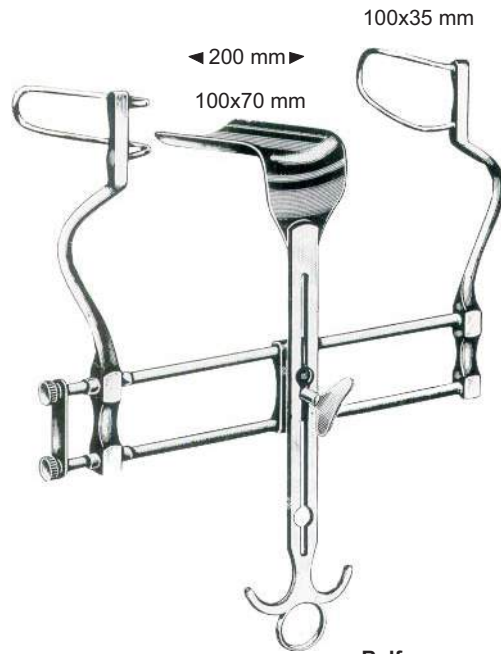

Balfour

- Retractor, complete
17-05968-00

- Retractor, only
17-05968-01

- Central blade, only
17-05968-02

Retractor, complete
17-05972-00

Retractor, only
17-05972-01

Central blade, only
17-05972-02
45x68 mm

Lateral blades, only
17-05972-04
60 mm

17-05972-03
68x85 mm

17-05972-05
80 mm

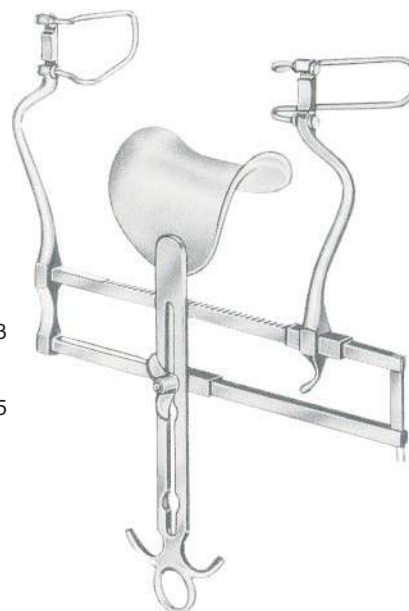

Balfour USA-Modell

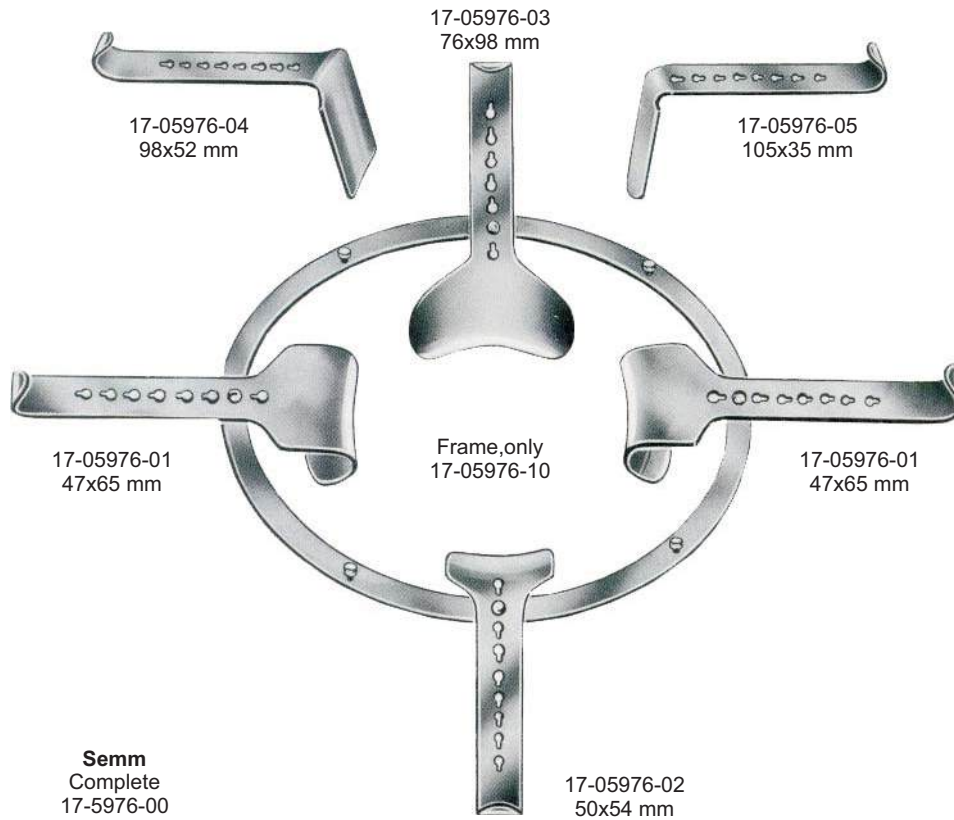



Frame

17-05988-10 178x140 mm
17-05990-20 255x178 mm



Fig.1 17-05988-01 38x38 mm
Fig.2 17-05988-02 38x25 mm

Complete
17-05988-00
17-05990-00

Denis-Brown
Consisting of

1x 17-05988-10
1x 17-05990-20

2x 17-05988-01
2x 17-05988-02

2x 17-05988-02
2x 17-05988-02

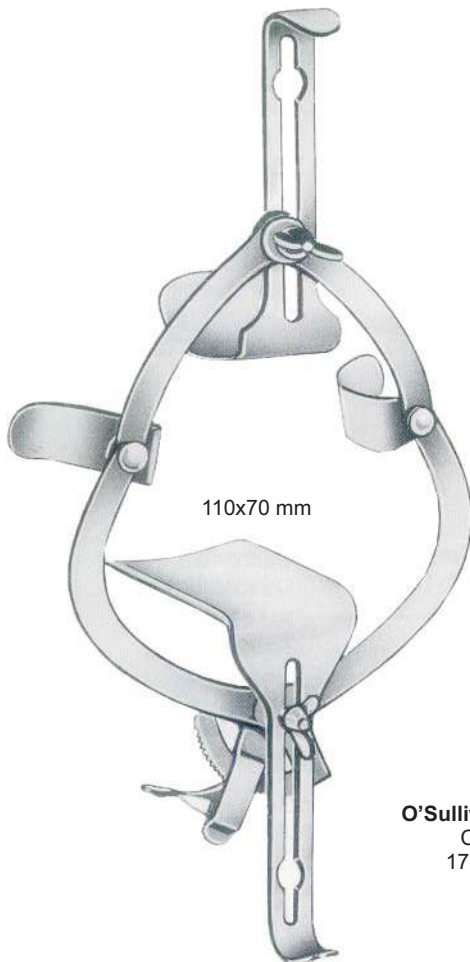

110x70 mm

O'Sullivan-O'Connor
Complete
17-05994-00



17-05994-01
80x45 mm



17-05994-02
80x45 mm



17-05994-03
110x70 mm

17-05998-01 38x60 mm
17-05998-02 45x80 mm



17-05998-03 50x65 mm
17-05998-04 60x85 mm

Foldable Frame
17-05998-10

Franz

Complete with 4 valves
17-5998-00

With
con 17-05998-10 1x
17-05998-01 2x
17 05998-03 2x

Complete with 8 valves
17-5999-00

With
con 17-05998-10 1x
17-05998-01 2x
17 05998-02 2x
17-05998-03 2x
17-05998-04 2x



17-06002-01 48x90 mm
17-06002-02 48x105 mm
17-06002-03 48x120 mm
17-06002-04 48x135 mm

Doyen
28cm/11"

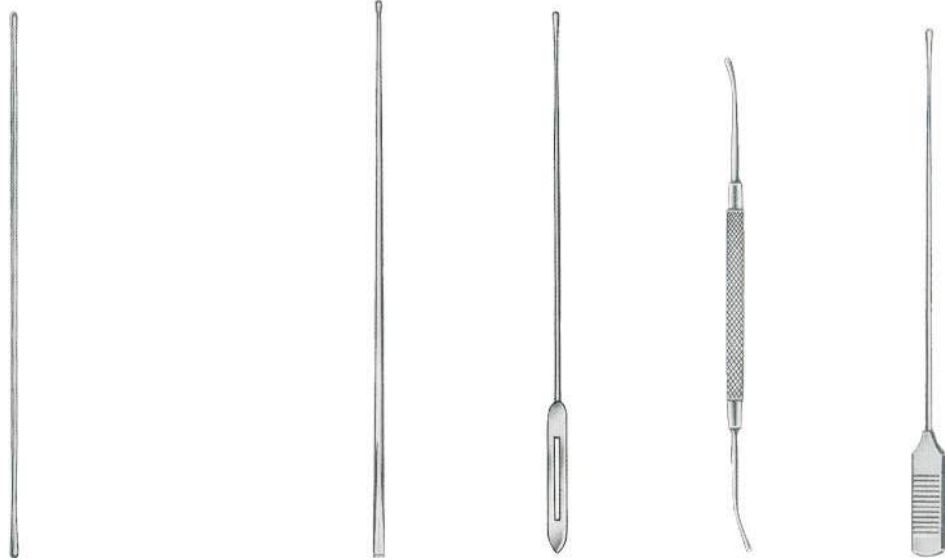

cm	In	1.0 mmØ	1.5 mmØ	2.0 mmØ	2.0 mmØ	Watson-Cheyne	Fish
11.5	4 1/2"	18-06004-11	18-06006-11	18-06008-11		18-06012-11	
13	5"	18-06004-13	18-06006-13	18-06008-13		18-06012-13	18-06016-13
14.5	5 3/4"	18-06004-14	18-06006-14	18-06008-14	18-06010-14	18-06012-14	18-06020-14
16	6 1/4"	18-06004-16	18-06006-16	18-06008-16	18-06010-16	18-06012-16	
18	7"	18-06004-18	18-06006-18	18-06008-18		18-06012-18	18-06016-18
20	8"	18-06004-20	18-06006-20	18-06008-20		18-06012-20	18-06020-18
25	10"	18-06004-25	18-06006-25	18-06008-25			



cm	In			Nelaton	Stacke 1.0 mm Ø	Brodie
10.5	4 1/4"				18-06036-10	
11.5	4 1/2"	18-06024-11				
13	5"	18-06024-13		18-06028-13	18-06032-13	
14.5	5 3/4"	18-06024-14	18-06025-14	18-06028-14	18-06032-14	
16	6 1/4"	18-06024-16		18-06028-16	18-06032-16	18-06040-16
18	7"	18-06024-18		18-06028-18		
20	8"	18-06024-20			18-06032-20	

Of tin



18-06044-25 25 cm/10"
18-06044-30 30 cm/12"
18-06044-40 40 cm/15¾"

Plaster spatulas



18-06048-13 13 cm/5"
18-06048-14 14 cm/5½"

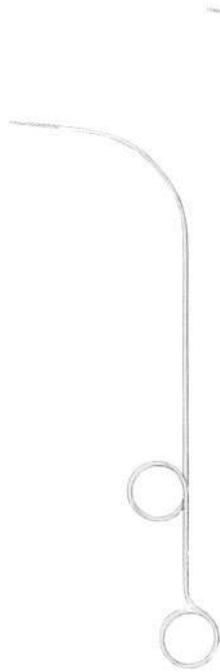

Pelteson
18-06052-23
23 cm/9"



Fein
18-06054-28
28 cm/11"



Buie
18-06058-16
16 cm/6¼"

Fistula probes



Lockhart-Mummary
16.5 cm/6½"



Fig. 1
18-6062-01



Fig. 2
18-6062-02



Fig. 3
18-6062-03



Fig. 4
18-6062-04



Pratt
21 cm/8¼"



18-06070-01



18-06070-02



18-06070-03



Universal

cm	in	1.2 mm Ø	1.5 mm Ø	1.7 mm Ø
12.5	5"	18-06074-12		
16	6¼"	18-06074-16		
18	7"	18-06074-18	18-06075-18	18-06076-18



Uckermann
 18-06078-16
 16 cm/6¼"



Jobson-Horne
 18-06080-13 13 cm/5"
 18-06080-18 18 cm/7"



Round Triangular

Farrell
 (Farrell-Lathbury)

cm	in	0.9 mm Ø	1.1 mm Ø	1.2 mm Ø	1.5 mm Ø	1.5 mm Ø
12	4¾"			●	▲	
14	5½"	18-06084-14	18-06086-14			
16	6¼"	18-06084-16	18-06086-16			
18	7"					



Round Triangular

1.2 mm Ø	1.5 mm Ø	1.5 mm Ø
●	●	▲
18-06090-12	18-06092-12	18-06094-12
18-06090-14	18-06092-14	18-06094-14
18-06090-16	18-06092-16	18-06094-16
18-06090-18	18-06092-18	18-06094-18

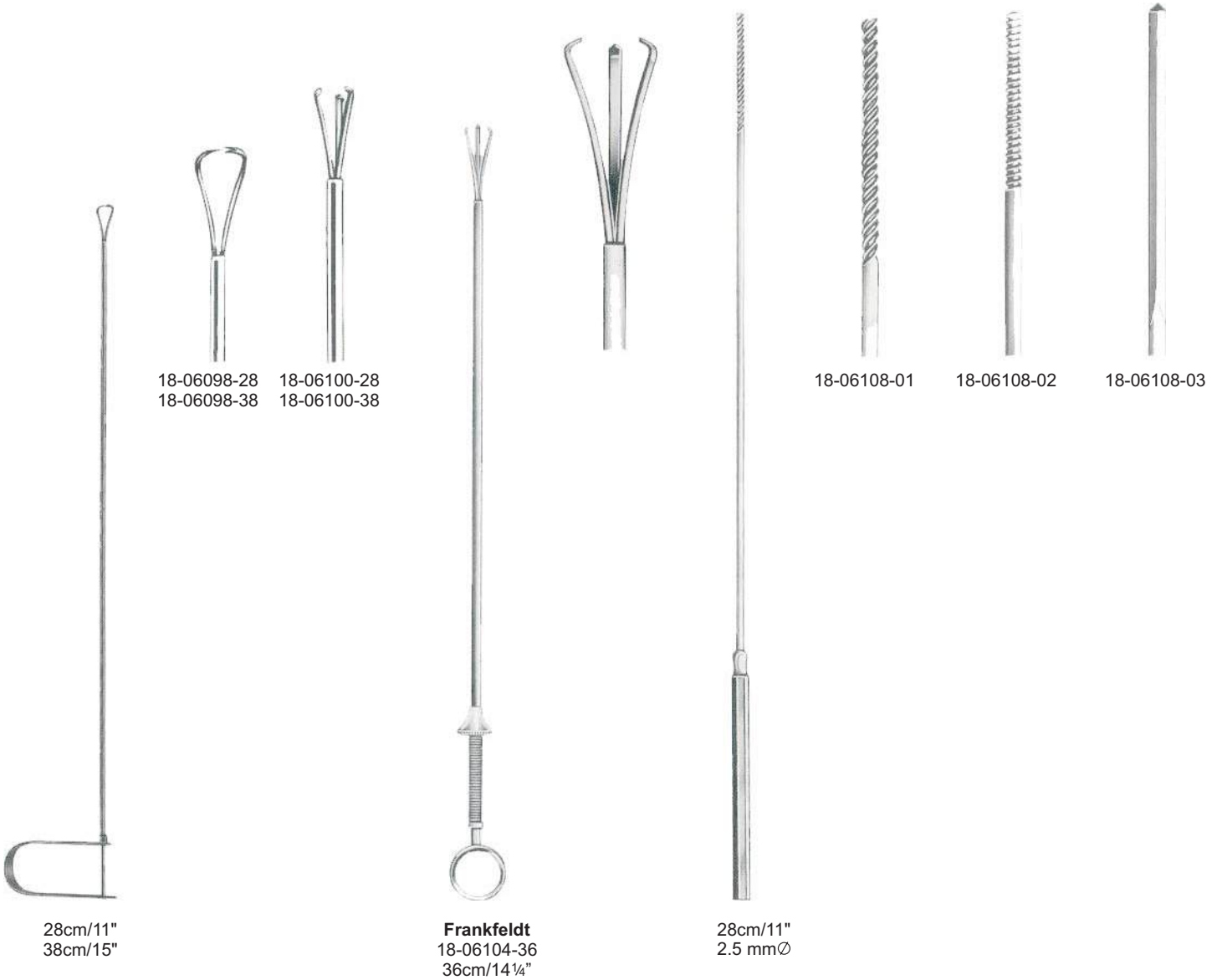



Nabatoff
18-06112-00
135x100x25 mm

Sterilizable

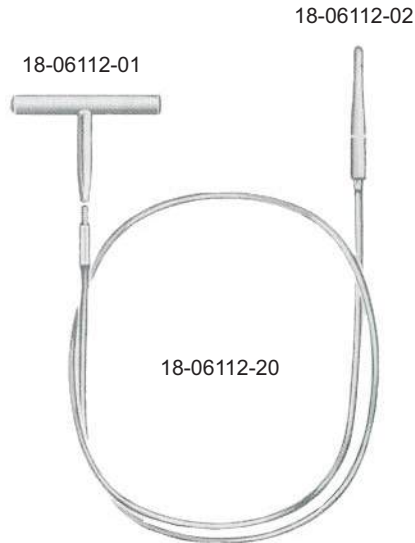

18-06112-01

18-06112-02

18-06112-20

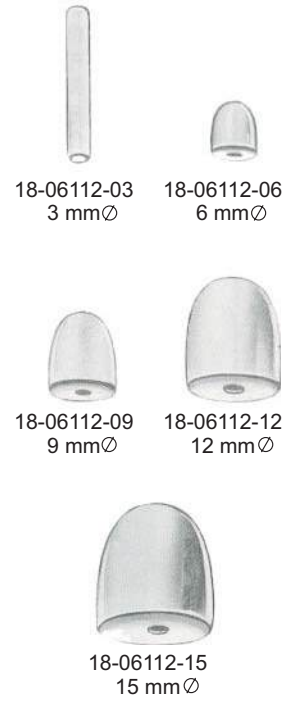

18-06112-03
3 mmØ

18-06112-06
6 mmØ

18-06112-09
9 mmØ

18-06112-12
12 mmØ

18-06112-15
15 mmØ

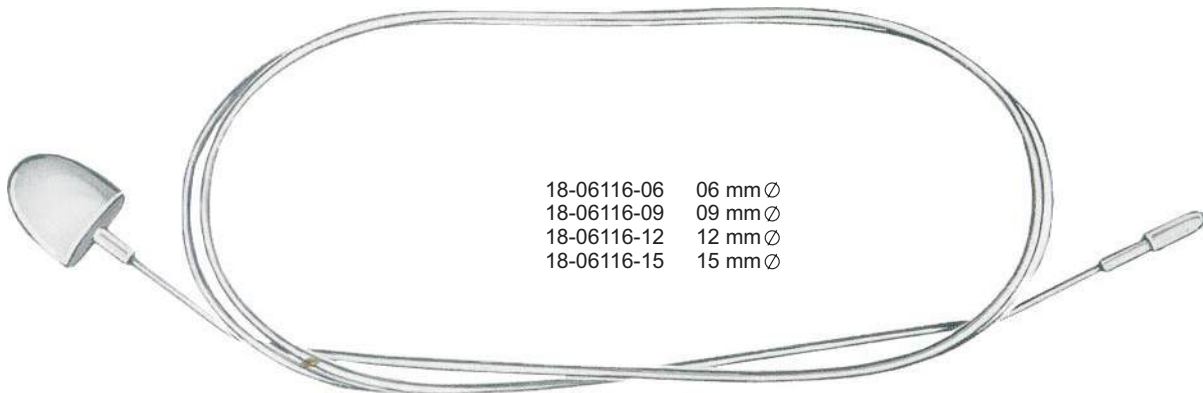

18-06116-06 06 mm Ø
18-06116-09 09 mm Ø
18-06116-12 12 mm Ø
18-06116-15 15 mm Ø

Myers

Strippers



55cm/21½"

	mm Ø
18-06120-02	2.0
18-06120-03	3.0
18-06120-04	4.0
18-06120-06	6.0
18-06120-07	7.0
18-06120-08	8.5
18-06120-10	10.0
18-06120-12	12.0
18-06120-14	14.0



Handle for
18-06120-00

Probes for Varicose Veins



Malleable

cm	in	
40	13½"	18-06124-40
50	20"	18-06124-50
65	26"	18-06124-65
80	32"	18-06124-80

Babcock

Vessel Irrigating Cannulas



Schimd



18-06128-03
3 mm Ø



18-06128-04
4 mm Ø



18-06128-05
5mmØ



18-06128-06
6mmØ

Spatulas



3 mm
Blunt

18-06132-18 18.0 cm/7"
18-06132-21 21.5 cm/8½"



Schmid



18-06136-14
14 cm/5½"
5 mm



18-06136-24
24 cm/9¼"
7 mm



Castroviejo
14cm/5 1/2"

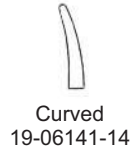
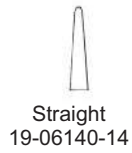

Castroviejo

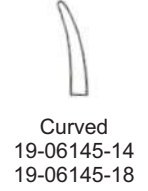
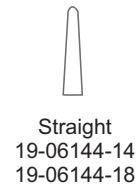

Castroviejo
9cm/3 1/2"

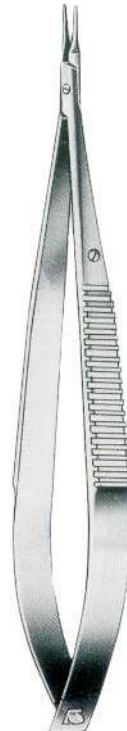

Castroviejo
14cm/5 1/2"





Castroviejo
9 cm/3½"

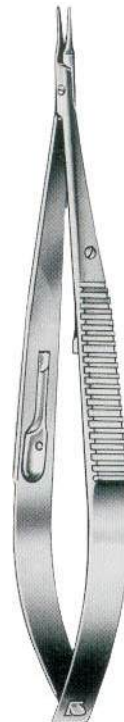

Castroviejo
14 cm/5½"

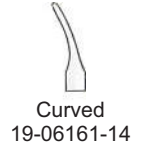

Paton
19-06164-11
11.5 cm/4½"



Jacobson

cm	in	Without ratchet	With ratchet
18	7"	19-06168-18	19-06170-18
21	8¼"	19-06168-21	19-06170-21



Straight

19-06174-20 20.0 cm/8"
19-06174-22 22.5 cm/9"



Curved

19-06175-16 16.5 cm/6½"
19-06175-20 20.0 cm/9"
19-06175-22 22.5 cm/9"
19-06175-24 24.5 cm/9¾"



Straight

19-06178-16 16.0 cm/6¼"
19-06178-18 18.5 cm/7¼"



Curved

19-06179-16 16.0 cm/6¼"
19-06179-18 18.5 cm/7¼"

Yasargil



Straight
19-06182-15
15 cm/6"



Curved
19-06183-15
15 cm/6"

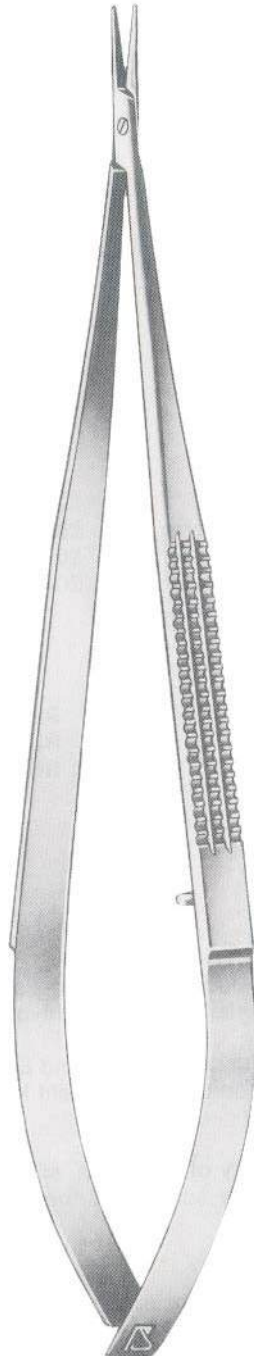

Straight
19-06186-18
18 cm/7"

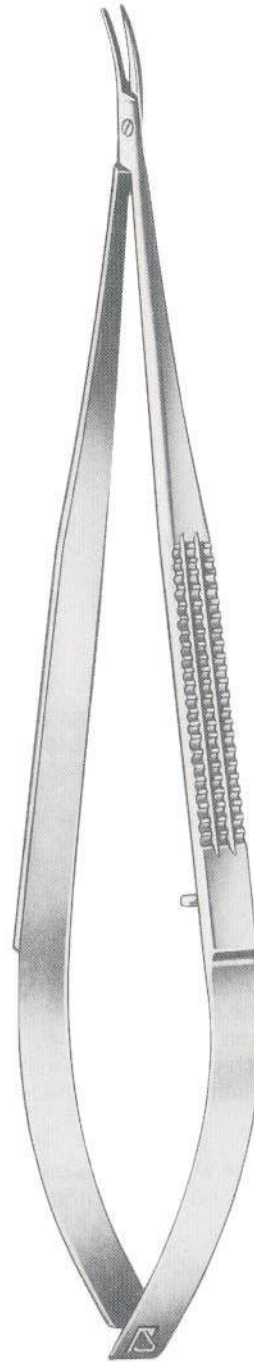

Curved
19-06187-18
18 cm/7"

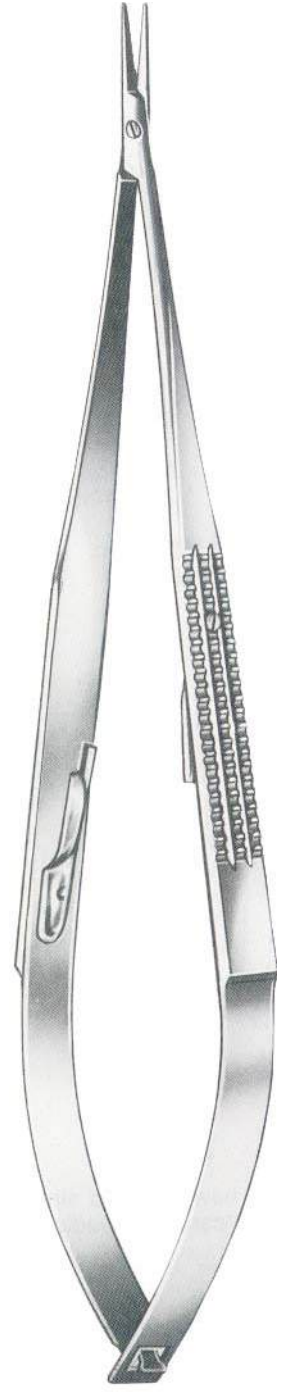

Straight
19-06190-18
18 cm/7"

Straight

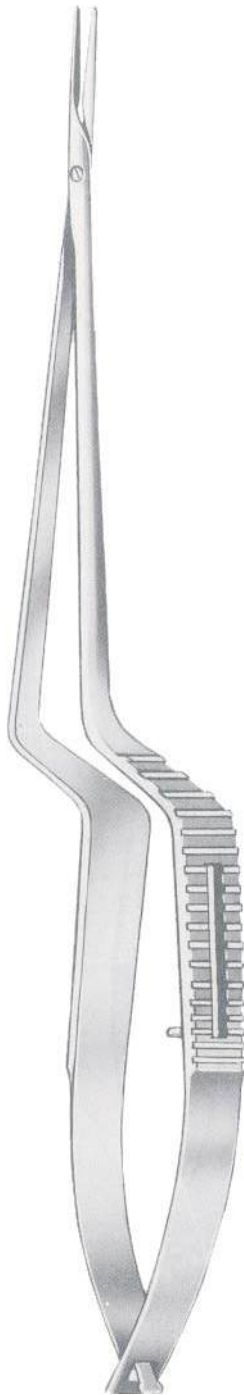

19-06194-18
19-06194-22

Curved

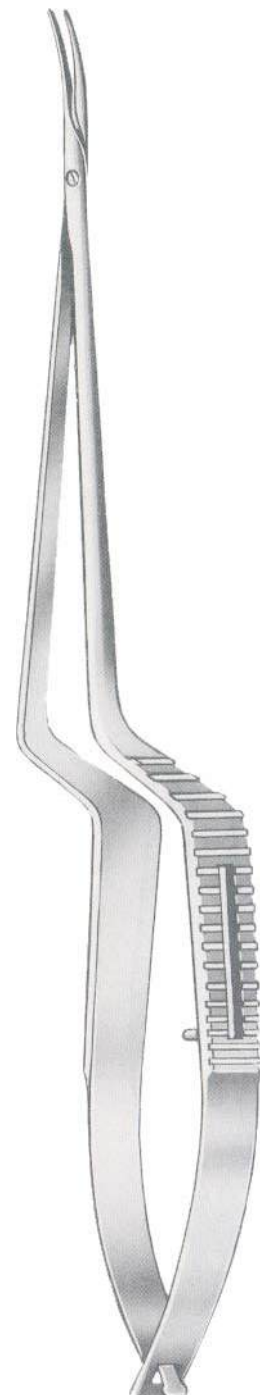

19-06195-18
19-06195-22

Yasargil
18.0 cm/7"
22.5 cm/8¾"



Straight
19-06198-15
15 cm/6"



Curved
19-06199-15
15 cm/6"



Straight
19-06206-15
15 cm/6"



Curved
19-06207-15
15 cm/6"



Straight
19-06210-18
18.5 cm/7¼"



Curved
19-06211-18
18.5 cm/7¼"



Straight
19-06214-18
18.5 cm/7¼"

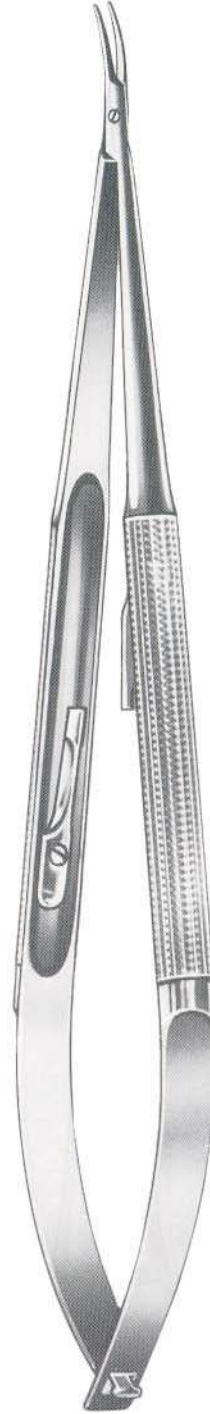

Curved
19-06215-18
18.5 cm/7¼"



23 cm/9"



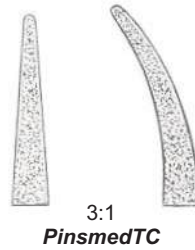

Straight



Curved

19-06222-18 18 cm/7"
19-06222-21 21 cm/8¼"
19-06222-23 23 cm/9¼"

With ratchet

19-06223-18 18 cm/7"
19-06223-21 21 cm/8¼"
19-06223-23 23 cm/9¼"

Without ratchet

The new modified structure of a Mouth aires the possibility of the smooth , slide surface of the suture material.
The "careful" Needleholder does not cause notches on the surface of the needles. The needle would not loose her gliding ability.



Straight
19-06226-12
12 cm/4¾"



Curved
19-06227-12
12 cm/4¾"



Angled
19-06229-12
12 cm/4¾"



Straight
19-06232-12
12 cm/4¾"



Curved
19-06233-12
12 cm/4¾"

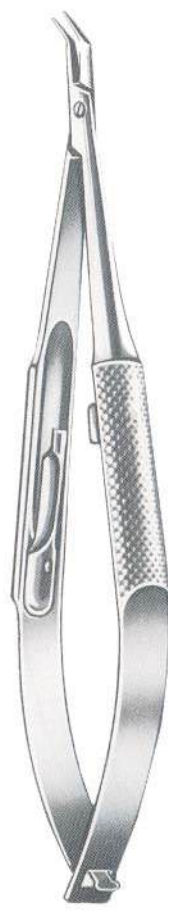

Angled
19-06235-12
12 cm/4¾"



Arruga
14 cm/5½"

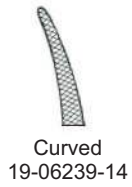
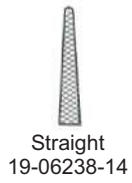

Stevens
19-06242-13 13 cm/5"
19-06242-15 15 cm/6"



Kalt
19-06246-14
14 cm/5½"



Castroviejo-Kalt
19-06248-13
13.5 cm/5¼"



Kalt-Arruga
19-06250-14
14 cm/5½"



Castroviejo
12cm/4 $\frac{3}{4}$ "



Castroviejo
12cm/4 $\frac{3}{4}$ "



Castroviejo
19-06262-13
13cm/5"



Boynton
19-06266-12
12cm/4 $\frac{3}{4}$ "

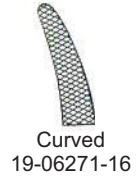
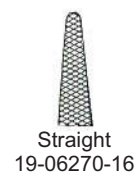

Arruga
16cm/6 $\frac{1}{4}$ "



Castroviejo

14cm/5½"
18cm/7"
21cm/8¼"

PinsmedTC

Smooth



19-06274-14
19-06274-18
19-06274-21



19-06278-14
19-06278-18
19-06278-21



14cm/5½"
18cm/7"
21cm/8¼"

19-06275-14
19-06275-18
19-06275-21



19-06279-14
19-06279-18
19-06279-21



Kalt
14cm/5½"



19-06282-14



19-06284-14



Barraquer
19-06288-14
14cm/5½"



Castroviejo
19-06292-13
13cm/5"



19-06296-18



19-06298-18
Smooth



Hepp-Schiedel
18cm/7"

PinsmedTC



Arruga
14cm/5½"

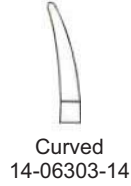

Jacobson
19-06306-18 18cm/7"
19-06306-20 20cm/8"
19-06306-23 23cm/8¾"



Diethrich

Straight		Curved
19-06310-16	16cm/6¼"	19-06311-16
19-06310-18	18cm/7"	19-06311-18
19-06310-20	20cm/8"	19-06311-20
19-06310-23	23cm/9"	19-06311-23
19-06310-25	25cm/10"	19-06311-25



19-06314-13



19-06315-13

Smooth



Halsey
13cm/5"

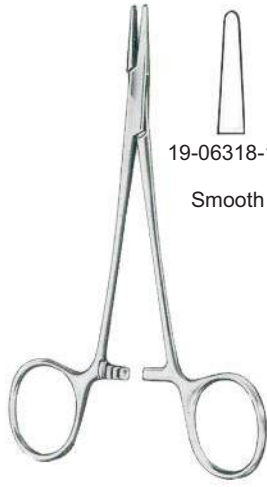

Webster
13cm/5"



19-06318-13

Smooth



Derf
19-06322-12
12cm/4¾"



Derf
19-06324-12
12.5cm/5"



Collier
19-06326-12
12.5cm/5"



Hegar-Baumgartner
19-06330-14
14cm/5½"



Brown
19-06334-13 13cm/5"
19-06334-18 18cm/7"



New Orleans
19-06338-18
18cm/7"





Mayo-Hegar

13cm/5"	19-06342-13	
14cm/5½"	19-06342-14	
16cm/6¼"	19-06342-16	19-06343-16
18cm/7"	19-06342-18	19-06343-18
20cm/8"	19-06342-20	19-06343-20
24cm/9½"	19-06342-24	19-06343-24
26cm/10¼"	19-06342-26	19-06343-26
30cm/12"	19-06342-30	19-06343-30



Heaney
19-06347-21
21cm/8¼"

Delicate Pattern



Mayo-Hegar
19-06350-16 16cm/6¼"
19-06350-18 18cm/7"
19-06350-20 20cm/8"

Heavy Pattern



Hegar
19-6354-16 16cm/6¼"
19-6354-18 18cm/7"
19-6354-20 20cm/8"



M.G.H.
(Mass.-General-Hospital)
19-06358-17
17 cm/6¾"



Sarat
19-06362-18 18.5 cm/7¼"
19-06362-26 26.0 cm/10¼"



Finocchietto
19-06365-27
27 cm/10½"



Masson
19-06368-27
27 cm/10½"



Jameson
19-06372-23
23.5 cm/9¼"



Wangensteen
19-06376-27
27 cm/10½"



Crile-Wood
19-06380-15
15 cm/6"



Crile-Murray
19-06384-15
15 cm/6"



Adson
19-06388-18
18 cm/7"



Ermold
19-06392-17 17 cm/6¾"
19-06392-20 20 cm/8"

Needle holders with scissors



Baby-Olsen-Hegar
11.5 cm/4½"



Smooth
19-06396-11



Olsen-Hegar
19-06398-14 14 cm/5½"
19-06398-18 18 cm/7"



Olsen-Hegar
19-06400-17
17 cm/6¾"



Olsen-Hegar
19-06404-14
14 cm/5½"



Gillies
19-06406-16
16 cm/6¼"



Gillies Slim
19-06408-14
14 cm/5½"



Crile
19-06412-15
15 cm/6"



Axhausen
19-06416-18
18.5 cm/7¼"



Lichtenberg
19-06420-20
20 cm/8"



Toennis
19-06424-18
18 cm/7"



Mathieu



19-06428-14 14 cm/5½"
19-06428-17 17 cm/6¾"
19-06428-20 20 cm/8"



19-06430-14
19-06430-17
19-06430-20



Mathieu

19-06434-14 14 cm/5½"
19-06434-17 17 cm/6¾"
19-06434-20 20 cm/8"

Two rings angled

PinsmedTC



Neivert
19-06438-13
13 cm/5"

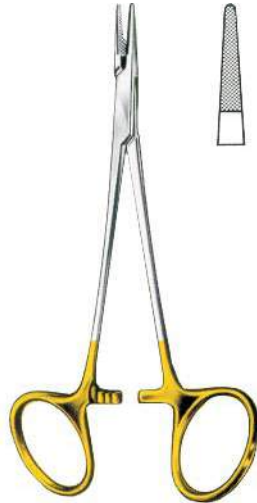

Neivert
19-06440-13
13 cm/5"



Webster
19-06444-13
13 cm/5"

Smooth



Derf
19-06448-12
12.5 cm/5"



New Orleans
19-06452-18
18 cm/7"



Bozemann
19-06456-20 20 cm/8"
19-06452-24 24 cm/9½"
19-06452-26 26 cm/10½"

PinsmedTC



19-06460-16
19-06460-18
19-06460-20
19-06460-24
19-06460-26
19-06460-30

19-06461-20
19-06461-24
19-06461-26

16cm/6¼"
18cm/7"
20cm/8"
24cm/9½"
26cm/10½"
30cm/12"



Mayo-Hegar



Hegar-Baumgartner
19-06464-14
14cm/5½"



Heavy Pattern

Mayo-Hegar
19-06470-20 20cm/8"
19-06470-24 24cm/9½"



De Bakley
19-06474-18
19-06474-20
19-06474-23
19-06474-26
19-06474-31

18cm/7"
20cm/8"
23cm/9"
26cm/10¼"
31cm/12¼"



De Bakley-Fine
19-06476-18
19-06476-20
19-06476-23
19-06476-26
19-06476-31

PinsmedTC



Baby-Crile-Wood
19-06480-15
15cm/6"

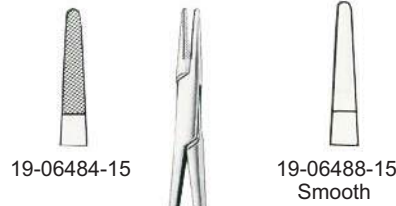

19-06484-15

19-06488-15
Smooth



Crile-Wood
15cm/6"



Crile-Wood

	cm	in
19-06492-18	18	7"
19-06492-20	20	8"
19-06492-23	23	9"
19-06492-26	26	10¼"
19-06492-31	31	12¼"

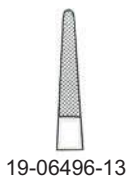

19-06496-13

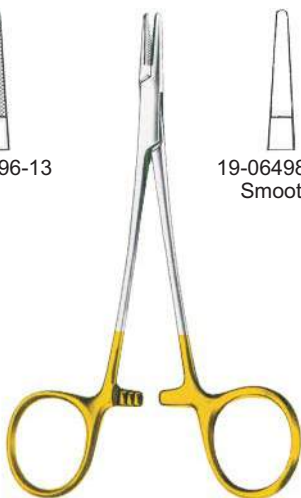

Halsey
13cm/5"



19-06498-13
Smooth



Converse
19-06502-12
12.5cm/5"



Kilner
19-06506-13
13.5cm/5¼"

PinsmedTC



Hegar-Vascular
19-06510-14 14cm/5½"
19-06510-18 18cm/7"
19-06510-20 20cm/8"
19-06510-23 23cm/9"



Ryder
19-06514-13
19-06514-15
19-06514-18
19-06514-20
19-06514-23
19-06514-26



Micro-Ryder
19-06516-13 13cm/5"
19-06516-15 15cm/6"
19-06516-18 18cm/7"
19-06516-20 20cm/8"
19-06516-23 23cm/9"
19-06516-26 26cm/10¼"



(Swedish Pattern)
19-06520-15 15cm/6"
19-06520-17 17cm/6¾"
19-06520-20 20cm/8"



Sarot
19-06524-18 18cm/7"
19-06524-26 26cm/10¼"

PinsmedTC

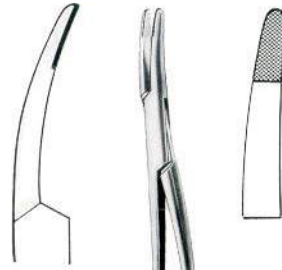

Stratte
19-06528-23
23cm/9"



Masson
19-06532-27
27cm/10½"



Wangensteen
19-06534-27
27cm/10½"



Finocchietto
19-06537-20 20cm/8"
19-06537-27 27cm/10½"

PinsmedTC



Mathieu

14cm/5½"	19-06540-14
17cm/6¾"	19-06540-17
20cm/8"	19-06540-20
24cm/9½"	19-06540-24



Mathieu

19-06542-14
19-06542-17
19-06542-20
19-06542-24



Mathieu-Ryder

19-06544-17
19-06544-20



Langenbeck

16cm/6¼"	19-06548-16
18cm/7"	19-06548-18
20cm/8"	19-06548-20



Langenbeck-Ryder

19-06550-18
19-06550-20



Lichtenberg

19-06554-20

PinsmedTC



Toennis
19-06558-18
18 cm/7"



Mathieu-Kocher
19-06562-14 14 cm/5½"
19-06562-17 17 cm/6¾"
19-06562-20 20 cm/8"



Axhausen
19-06566-18
18.5 cm/7¼"



Zweifel
19-06570-20 20 cm/8"
19-06570-23 23 cm/9"

PinsmedTC



19-06574-20 20 cm/8"
19-06574-25 25 cm/10"



Mathieu
19-06578-20 20 cm/8"
19-06578-24 24 cm/9½"



Metzenbaum
19-06582-17 17 cm/6¾"
19-06582-20 20 cm/8"



Arruga
16 cm/6¼"



Boynton
19-06590-12 12 cm/4¾"



Hosel
19-06594-20 20 cm/8"
19-06594-25 25 cm/10"

PinsmedTC



Baby-Olsen-Hegar
19-06598-11
11.5 cm/4½"



Olsen-Hegar
19-06600-14
14 cm/5½"



Olsen-Hegar
19-06602-17
17 cm/6¾"



Olsen-Hegar
19-06604-18
18 cm/7"



Gillies-Slim
19-06607-14
14.5 cm/5½"



Gillies
19-06609-16
16 cm/6¼"

Left



20 cm/8"



19-06612-01



Blunt



19-06612-02



19-06617-01



Sharp



19-06617-02

Deschamps-Standard

Right



20 cm/8"



20 cm/8"



19-06622-01



Blunt



19-06622-02



19-06627-01



Sharp



19-06627-02

Deschamps



20 cm/8"

Left Right

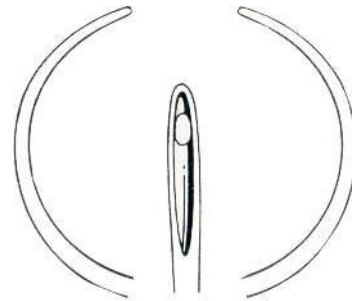

Left

Right

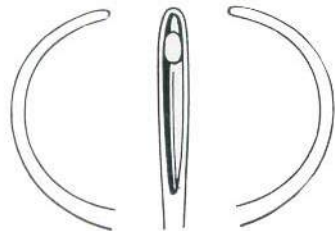

19-06632-01 Blunt 19-06632-02

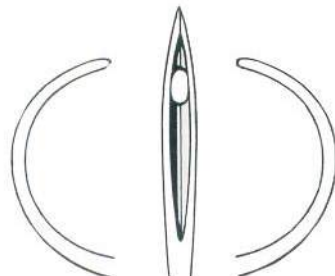

19-06637-01 Sharp 19-06637-02

21cm/8¼"

Deschamps

21 cm/8¼"



Deschamps

24 cm/9½"

19-06642-01

19-06642-02

Left

Right

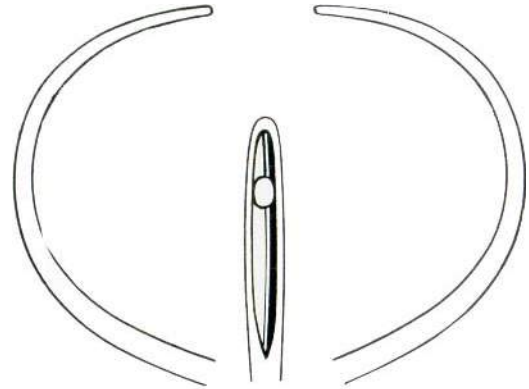

Left

Right

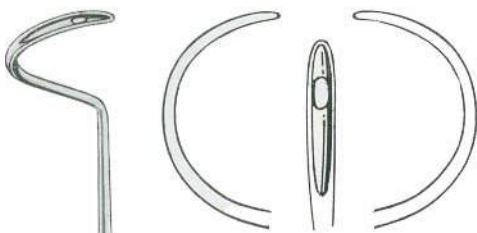

Blunt

19-06648-01 19-06648-02

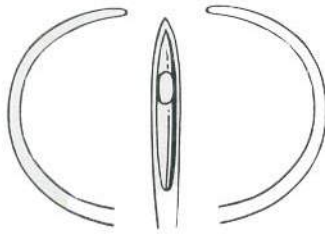

Sharp

19-06653-01 19-06653-02



27 cm/10 1/2"

Deschamps



27 cm/10 1/2"



Deschamps
19-06658-01 28 cm/11" 19-06658-02



Kocher
19 cm/7½"

19-06664-01

19-06664-02

19-06664-03



Kronecker
19-06672-01 13 cm/5" 19-06672-02

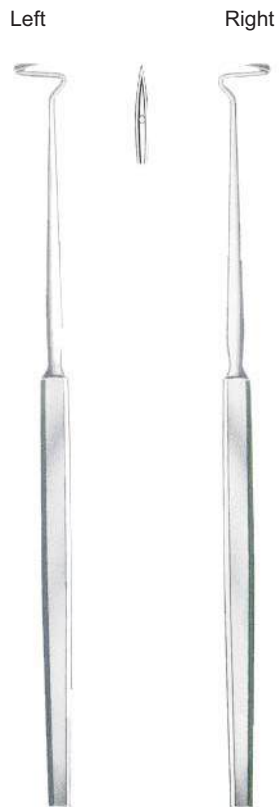

Dupuy-Weiss
19-06677-01 22 cm/8¾" 19-06677-02



Durham
19-06685-01 21 cm/8¼" 19-06685-02

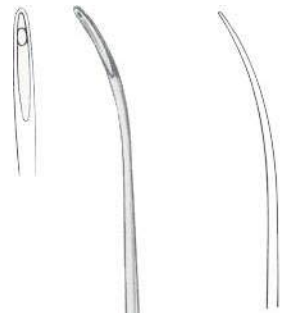

Flexible



Schmieden-Dick
19-06690-32
32 cm/12½"



Schmieden
19-06694-21
21 cm/8¼"



Flexible



Cooper
19-06702-19
19 cm/7½"



With 1 needle

Young

19-06705-21 21 cm/8¼"
19-06707-25 25 cm/10"



19-06705-01



19-06705-02



19-06705-03

Spare needle only



Reverdin
14 cm/5½"



Fig. 1
19-06711-01



Fig. 2
19-06711-02



Fig. 3
19-06711-03



Fig. 4
19-06711-04



Reverdin
19.5 cm/7¾"



Fig. 1
19-06715-01



Fig. 2
19-06715-02



Fig. 3
19-06715-03



Fig. 4
19-06715-04



Reverdin
22.5 cm/8¾"



Fig. 1
19-06717-01



Fig. 2
19-06717-02



Fig. 3
19-06717-03



Fig. 4
19-06717-04



Brunner
19-06720-25
25 cm/10"



Payr
19-06724-22
22 cm/8¾"



Payr
19-06726-22
22 cm/8¾"



Brunner
19-06730-24
24.5 cm/9¾"

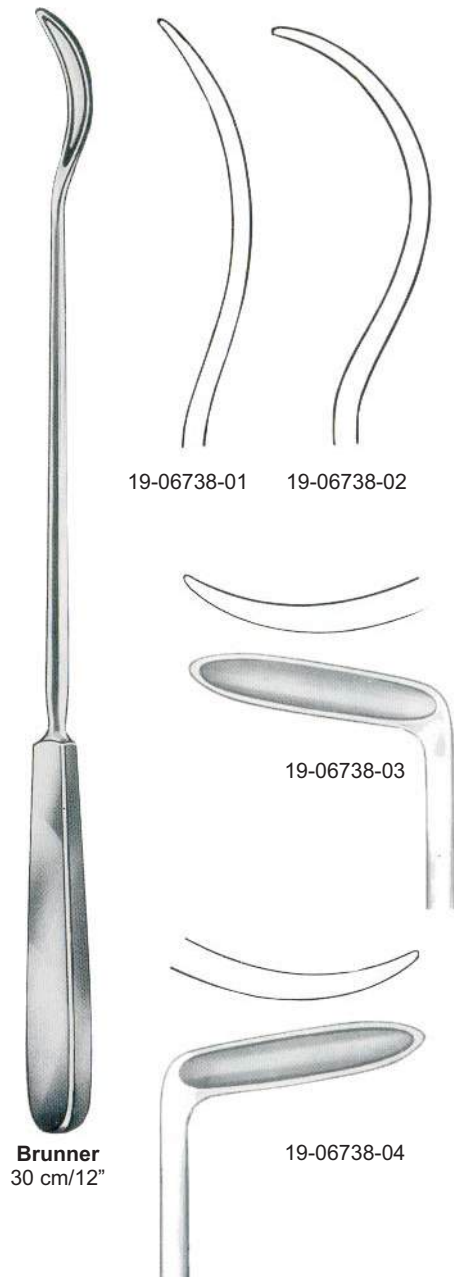
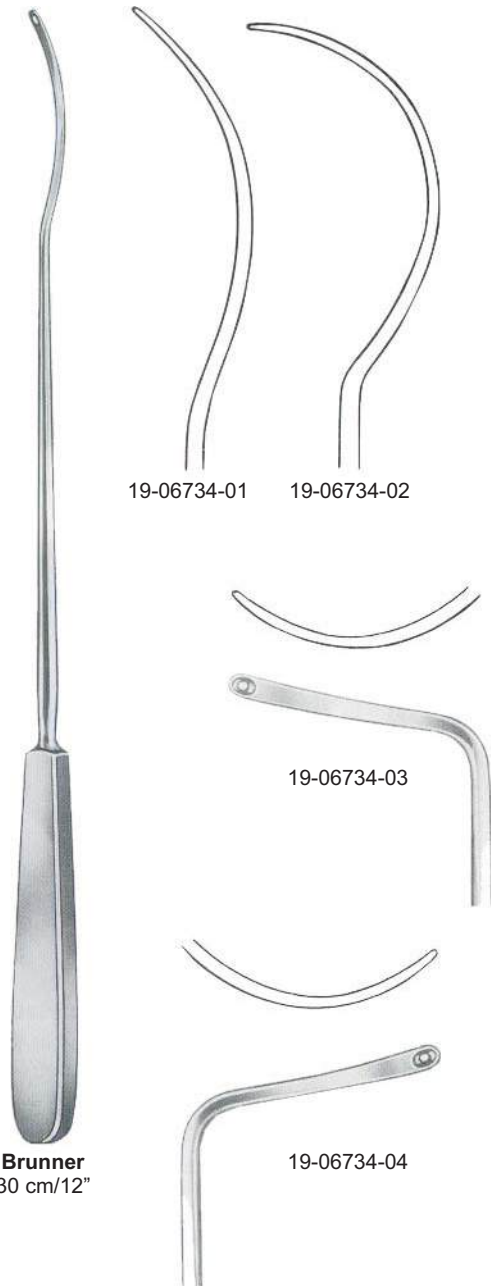



Kirschner
19-06742-25
25.5 cm/10"

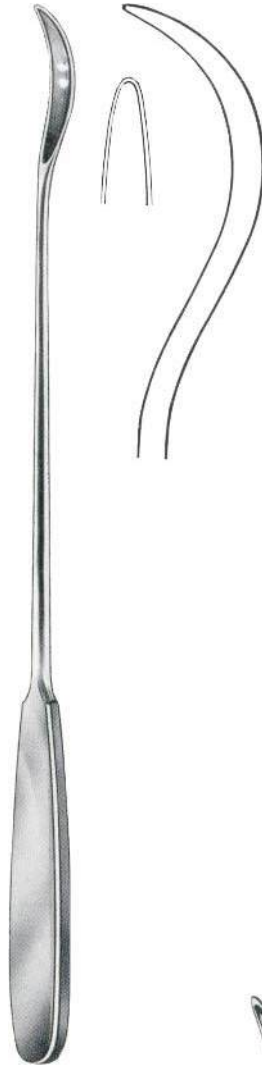

Brunner-Ferrozell
19-06750-18 18 cm/7"
19-06750-27 27 cm/10½"



Schmieden-Payr
19-06754-19
19 cm/7½"



Schmieden
19-06756-19
19 cm/7½"



Konig
19-06760-19
19.5 cm/7¾"



Konig
19-06762-19
19.5 cm/7¾"



Konig
19-06764-20
20 cm/8"



Wien
19-06768-23
23.5 cm/9¼"



Bozemann
19-06772-21
21 cm/8¼"



19-06776-23
23 cm/9"



Micheal
19-06780-12
12 cm/4¾"



Micheal
19-06782-12
12 cm/4¾"



Wachenfeldt
19-06786-12
12 cm/4¾"



Wachenfeldt
19-06788-12
12 cm/4¾"



Wachenfeldt
19-06790-13
13 cm/5"



Wachenfeldt
19-06792-13
13 cm/5"



Michel
19-06796-12
12 cm/4¾"



Michel Modif
19-06798-12
12.5 cm/5"



Collin
19-06802-13
13 cm/5"



Richter-Heath
19-06806-14
14 cm/5½"



Child
19-06810-17
17 cm/6¾"



Child
19-06812-17
17 cm/6¾"



Hopkins
20-06816-20
20 cm/8"



Esmarch
20-06820-18
18 cm/7"



Reiner
20-06824-18
18.5 cm/7¼"

Plaster Saw



Engel
20-06828-14
14cm/5½"



Henning
20-06832-28
28 cm/11"



Beeson
20-06836-30
30 cm/12"



Haglund-Stille
20-06840-28
28 cm/11"



Mod. USA
20-06844-23
23 cm/9"



Wolff
20-06848-18 18 cm/7"
20-06848-24 24 cm/9½"



Stille
20-06852-24
24 cm/9½"



Stille
20-06856-23 23 cm/9"
20-06856-26 26 cm/10¼"
20-06856-37 37 cm/14½"



mm	Partsch	
02	21-06860-02	21-06862-02
03	21-06860-03	21-06862-03
04	21-06860-04	21-06862-04
05	21-06860-05	21-06862-05
06	21-06860-06	21-06862-06
07	21-06860-07	21-06862-07
08	21-06860-08	21-06862-08
	13.5 cm/5¼"	17 cm/6¾"



mm	Partsch	
02	21-06866-02	21-06868-04
03	21-06866-03	21-06868-06
04	21-06866-04	21-06868-08
05	21-06866-05	21-06868-10
06	21-06866-06	21-06868-12
07	21-06866-07	21-06868-14
08	21-06866-08	21-06868-16
	13.5 cm/5¼"	17 cm/6¾"

Width



mm	Width		
04	21-06870-04	21-06872-04	21-06874-04
06	21-06870-06	21-06872-06	21-06874-06
08	21-06870-08	21-06872-08	21-06874-08
10	21-06870-10	21-06872-10	21-06874-10
12	21-06870-12	21-06872-12	21-06874-12
14	21-06870-14	21-06872-14	21-06874-14
16	21-06870-16	21-06872-16	21-06874-16
	13.5 cm/5¼"		

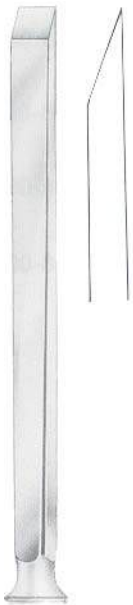

mm	Mod. USA	
06	21-06878-06	21-06880-06
12	21-06878-12	21-06880-12
18	21-06878-18	21-06880-18
		16 cm/6¼"



21-06882-06
21-06882-12
21-06882-18



16 cm/6¼"

- 21-06886-03
3mm
- 21-06886-05
5mm
- 21-06886-07
7mm
- 21-06886-09
9mm



Passow
12 cm/4¾"

- 21-06890-02
2.5mm
- 21-06890-03
3.5mm



Lexer
27.5 cm/10¾"

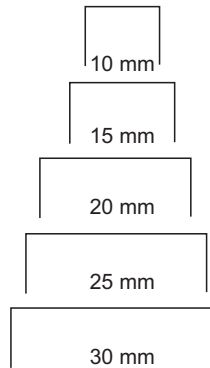

- 21-06893-10
- 21-06893-15
- 21-06893-20
- 21-06893-25
- 21-06893-30

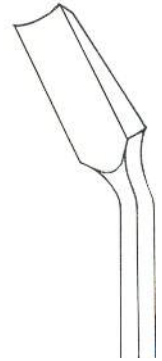

- 21-06895-10
- 21-06895-15
- 21-06895-20
- 21-06895-25
- 21-06895-30



Cloward
24 cm/9½"

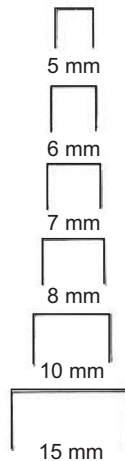

- 21-06898-05
- 21-06898-06
- 21-06898-07
- 21-06898-08
- 21-06898-10
- 21-06898-15



- 21-06900-05
- 21-06900-06
- 21-06900-07
- 21-06900-08
- 21-06900-10
- 21-06900-15



Alexander
18 cm/7"

	mm
21-06904-04	04
21-06904-06	06
21-06904-08	08
21-06904-10	10
21-06904-12	12
21-06904-14	14



21-06906-04
21-06906-06
21-06906-08
21-06906-10
21-06906-12
21-06906-14



Hoke

14 cm/5½"

	mm
21-06910-02	2
21-06910-03	3
21-06910-04	4
21-06910-05	5
21-06910-06	6
21-06910-07	7
21-06910-08	8

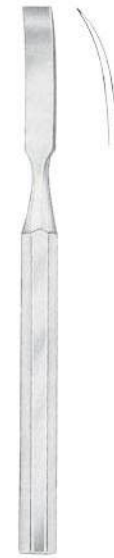

21-06911-02
21-06911-03
21-06911-04
21-06911-05
21-06911-06
21-06911-07
21-06911-08



Smith-Petersen
20 cm/8"



mm				
06	21-06914-06	21-06915-06	21-06918-06	21-06919-06
09	21-06914-09	21-06915-09	21-06918-09	21-06919-09
13	21-06914-13	21-06915-13		
14			21-06918-14	21-06919-14
16	21-06914-16	21-06915-16	21-06918-16	21-06919-16
19	21-06914-19	21-06915-19	21-06918-19	21-06919-19
25	21-06914-25	21-06915-25	21-06918-25	21-06919-25
32	21-06914-32	21-06915-32	21-06918-32	21-06919-32



Lambotte

	mm
21-06922-04	04
21-06922-06	06
21-06922-08	08
21-06922-10	10
21-06922-13	13
21-06922-16	16
21-06922-18	18
21-06922-20	20
21-06922-25	25
21-06922-30	30
21-06922-38	38
21-06922-44	44
21-06922-50	50

24 cm/9½"

Curved



21-06923-04
21-06923-06
21-06923-08
21-06923-10
21-06923-13
21-06923-16
21-06923-18
21-06923-20
21-06923-25
21-06923-30
21-06923-38
21-06923-44
21-06923-50

23 cm/9"



Mini-Lambotte

	mm	
21-06926-02	02	21-06927-02
21-06926-03	03	21-06927-03
21-06926-04	04	21-06927-04
21-06926-06	06	21-06927-06
21-06926-08	08	21-06927-08
21-06926-10	10	21-06927-10
21-06926-12	12	21-06927-12
21-06926-15	15	21-06927-15
12.5 cm/5"		17 cm/6¾"



Mini-Lexer

	mm	
21-06930-04	04	21-06932-04
21-06930-06	06	21-06932-06
21-06930-08	08	21-06932-08
21-06930-10	10	21-06932-10
21-06930-12	12	21-06932-12

18 cm/7"



Lexer

	mm	
21-06936-05	05	21-06938-05
21-06936-07	07	21-06938-07
21-06936-10	10	21-06938-10
21-06936-15	15	21-06938-15
21-06936-20	20	21-06938-20
21-06936-25	25	21-06938-25
21-06936-30	30	21-06938-30

22 cm/8¾"





Chisel
21-06942-20
24.5 cm/9 ³/₄"
20 mm



Chisel-Curved
21-06943-20
26.5 cm/10 ¹/₂"
20 mm

Gouge for the
removing of
broken screws



21-06944-22
22 cm/8 ³/₄"



Stille
20 cm/8"

mm
06
08
10
12
15
20
25
30

Width



21-06950-06	21-06952-06	21-06953-06	21-06956-06	21-06957-06
21-06950-08	21-06952-08	21-06953-08	21-06956-08	21-06957-08
21-06950-10	21-06952-10	21-06953-10	21-06956-10	21-06957-10
21-06950-12	21-06952-12	21-06953-12	21-06956-12	21-06957-12
21-06950-15	21-06952-15	21-06953-15	21-06956-15	21-06957-15
21-06950-20	21-06952-20	21-06953-20	21-06956-20	21-06957-20
21-06950-25	21-06952-25	21-06953-25	21-06956-25	21-06957-25
21-06950-30	21-06952-30	21-06953-30	21-06956-30	21-06957-30

Hibbs
24 cm/9½"

mm
06
09
13
16
19
25
32



21-06960-06	21-06961-06	21-06964-06	21-06966-06	21-06967-06
21-06960-09	21-06961-09	21-06964-09	21-06966-09	21-06967-09
21-06960-13	21-06961-13	21-06964-13	21-06966-13	21-06967-13
21-06960-16	21-06961-16	21-06964-16	21-06966-16	21-06967-16
21-06960-19	21-06961-19	21-06964-19	21-06966-19	21-06967-19
21-06960-25	21-06961-25	21-06964-25	21-06966-25	21-06967-25
21-06960-32	21-06961-32	21-06964-32	21-06966-32	21-06967-32



mm **Lexer**
05 21-06970-05
10 21-06970-10
15 21-06970-15
28 cm/11"



Lexer
21-06972-05
21-06972-10
21-06972-15
25 cm/10"



Lexer
21-06973-05
21-06973-10
21-06973-15
25 cm/10"



21-06976-01



21-06977-02



21-06977-03



Cobb
28 cm/11" 21-06977-04



Volkmann
17 cm/6¾"

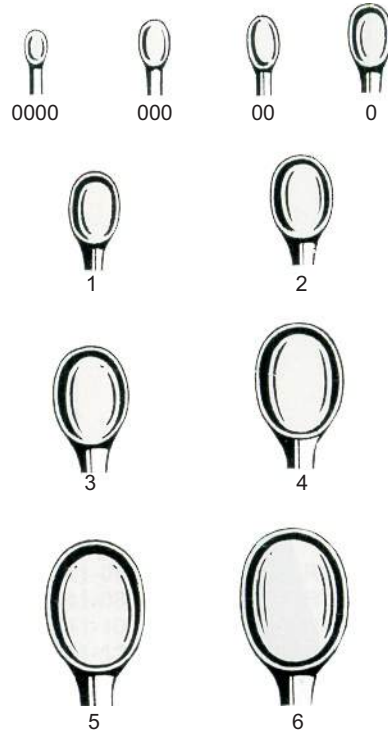

- Fig.
0000 21-06980-40
000 21-06980-30
00 21-06980-20
0 21-06980-10
1 21-06980-01
2 21-06980-02
3 21-06980-03
4 21-06980-04
5 21-06980-05
6 21-06980-06



Volkmann
17 cm/6¾"

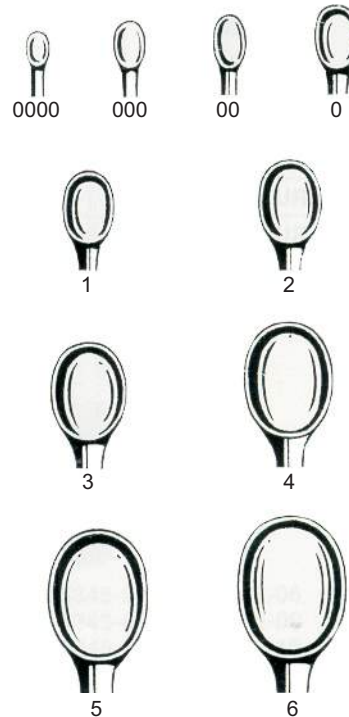

- Fig.
0000 21-06984-40
000 21-06984-30
00 21-06984-20
0 21-06984-10
1 21-06984-01
2 21-06984-02
3 21-06984-03
4 21-06984-04
5 21-06984-05
6 21-06984-06

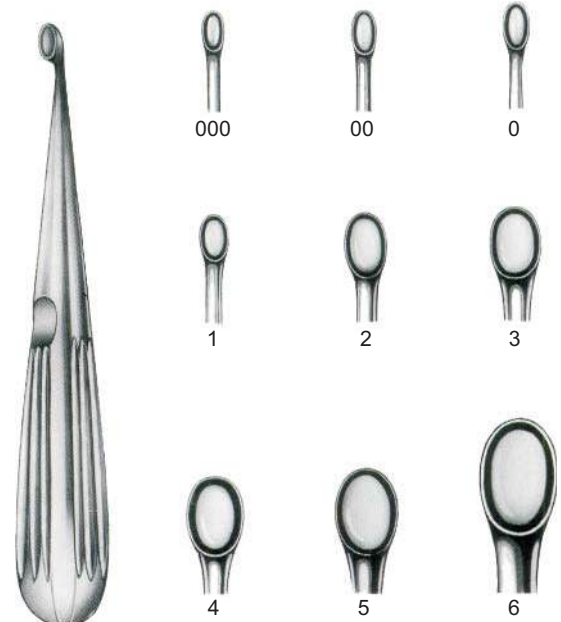

Fig.	A	B	C	D
000	21-06988-30	21-06990-30	21-06991-30	21-06993-30
00	21-06988-20	21-06990-20	21-06991-20	21-06993-20
0	21-06988-10	21-06990-10	21-06991-10	21-06993-10
1	21-06988-01	21-06990-01	21-06991-01	21-06993-01
2	21-06988-02	21-06990-02	21-06991-02	21-06993-02
3	21-06988-03	21-06990-03	21-06991-03	21-06993-03
4	21-06988-04	21-06990-04	21-06991-04	21-06993-04
5	21-06988-05	21-06990-05	21-06991-05	21-06993-05
6	21-06988-06	21-06990-06	21-06991-06	21-06993-06



Bruns
17 cm/6¾"

Bruns	Fig.	Spratt
21-06996-30	000	21-06998-30
21-06996-20	00	21-06998-20
21-06996-10	0	21-06998-10
21-06996-01	1	21-06998-01
21-06996-02	2	21-06998-02
21-06996-03	3	21-06998-03
21-06996-04	4	21-06998-04
21-06996-05	5	21-06998-05
21-06996-06	6	21-06998-06



Spratt
16 cm/6¼"



Swedish pattern

mm	Round	Oval
2	21-07002-02	21-07004-02
3	21-07002-03	21-07004-03
4	21-07002-04	21-07004-04
5	21-07002-05	21-07004-05
6	21-07002-06	21-07004-06
7	21-07002-07	21-07004-07
8	21-07002-08	21-07004-08
10	21-07002-10	21-07004-10
12	21-07002-12	21-07004-12
14	21-07002-14	21-07004-14
	17cm/6¾"	22cm/8½"



Schede
17 cm/6¾"

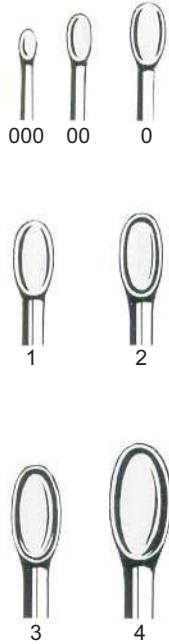
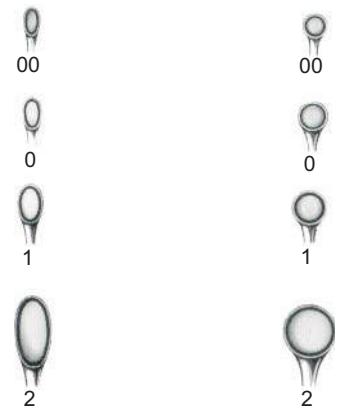

Fig.	
000	21-07008-30
00	21-07008-20
0	21-07008-10
1	21-07008-01
2	21-07008-02
3	21-07008-03
4	21-07008-04



Williger
17.5 cm/7"



Straight, Oval

21-07012-20
21-07012-10
21-07012-01
21-07012-02

Straight

Fig.	
00	21-07014-20
0	21-07014-10
1	21-07014-01
2	21-07014-02



21-07017-01

Uffenorde
17 cm/6¾"



21-07017-02



Fig. 0
21-07018-10



Fig. 1
21-07018-01



Fig. 2
21-07018-02



Fig. 3
21-07018-03



Volkmann
27 cm/10½"



Fig. 1
21-07020-01



Fig. 2
21-07020-02



Fig. 3
21-07020-03



Simon
24 cm/9½"



Fig. 4
21-07020-04



Fig. 5
21-07020-05



Fig. 6
21-07020-06



Fig. 0000
21-07022-40



Fig. 000
21-07022-30



Fig. 00
21-07022-20



Fig. 0
21-07022-10



Simon
24 cm/9½"



Fig. 00
21-07024-20



Fig. 0
21-07024-10



Fig. 1
21-07024-01



Fig. 2
21-07024-02



Daubenspeck
20 cm/8"

Flexible



Halle
21 cm/8¼"



25 cm/10"



Bushe
25 cm/10"



	Volkmann		Volkmann	
Length	Oval/Oval		Oval/Round	
cm	in			
13	5"	21-07038-13	21-07040-13	
14	5½"	21-07038-14		
16	6¼"		21-07040-16	
17	6¾"	21-07038-17		
20	8"	21-07038-20	21-07040-20	



Martini
13.5 cm/5"



Jansen
21-07046-15
15 cm/6"



Jansen
21-07050-16
16 cm/6¼"



Williger
13.5 cm/5"



Jacobson
21-07058-13
13 cm/5"



Janson
21-07062-15
15 cm/6"



Barth
21-07064-18
18 cm/7"



21-07066-21
21 cm/8 1/4"



Epstein



Spinal



Spinal

Fig.	21-07069-30	21-07072-30	21-07074-30
000	21-07069-20	21-07072-20	21-07074-20
0	21-07069-10	21-07072-10	21-07074-10
1	21-07069-01	21-07072-01	21-07074-01
2	21-07069-02	21-07072-02	21-07074-02
3	21-07069-03	21-07072-03	21-07074-03
4	21-07069-04	21-07072-04	21-07074-04
5	21-07069-05	21-07072-05	21-07074-05
6	21-07069-06	21-07072-06	21-07074-06
	20 cm/8"	20 cm/8"	20 cm/8"



Putti
21-07078-30
30 cm/12"



Putti
21-07080-27
27 cm/10½"



21-07084-25
25 cm/10"



21-07088-24
24 cm/9½"



21-07092-22
22 cm/8¾"



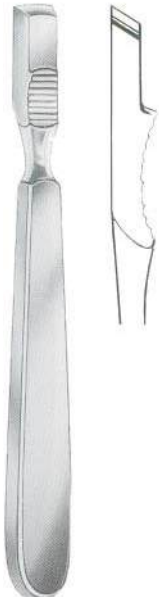

Farabeuf
21-07096-15
15 cm/6"



Farabeuf
21-07098-15
15 cm/6"



Farabeuf-Collin
21-07100-15
15.5 cm/6"
11 mm



Farabeuf-Collin
21-07102-15
15.5 cm/6"
11 mm



Farabeuf
21-07104-19
19 cm/7½"
13 mm



Sedillot
21-07108-18
18 cm/7"
18 mm



Sedillot
21-07110-21
21 cm/8¼"
15 mm



Langenbeck
21-07114-19
19 cm/7½"



Langenbeck
21-07116-18
18 cm/7"



Lambotte
21 cm/8¼"

Width

	mm
21-07120-05	05
21-07120-10	10
21-07120-15	15
21-07120-20	20
21-07120-25	25



Schneider
21-07124-17
13 mm
17.5 cm/7"



Schneider-Sauerbruch
21-07126-19
13 mm
19 cm/7½"



Alexander
21-07130-20
20 cm/8"



Jansen
21-07134-16
15 mm
16.5 cm/6½"



Seldin
21-07138-19
19 cm/7½"



Davidson-Alexander
21-07142-29
29 cm/11½"



Williger
21-07146-29
13 cm/5"

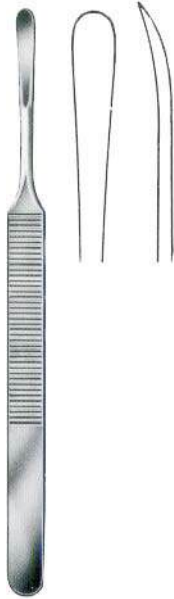

König
21-07150-15
15.5 cm/6"
5 mm



Williger
21-07154-16
16 cm/6¼"



Adson
17 cm/6¾"



21-07158-01



21-07158-02



21-07158-03



21-07158-04



21-07162-06 17 cm/6¾"
6 mm

21-07162-08
8 mm



Overholt
21-07166-29
29.5 cm/11½"



Overholt
21-07168-29
29.5 cm/11½"



Overholt
21-07170-28
28.5 cm/11¼"



Hyllin
21-07174-03
14.5 cm/5¾"



21-07174-01



21-07174-02



21-07174-03



Matson
21-07178-22
22 cm/8¾"



Semb

21-07182-01
19.5 cm/7½"
12 mm



21-07182-02
19.5 cm/7½"
12 mm



21-07182-03
19.5 cm/7½"
12 mm



21-07182-04
22 cm/8¾"
13 mm



21-07182-05
21.5 cm/8½"
13 mm



21-07182-06
22 cm/8½"
15 mm



21-07182-07
22 cm/8½"
15 mm



Doyen
17 cm/6¾"

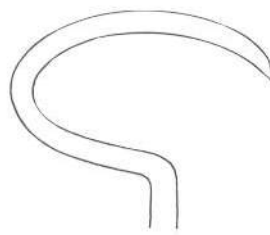

21-07186-01

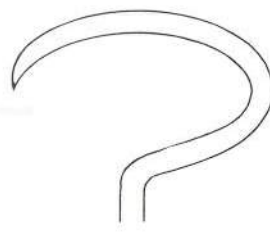

21-07186-02



21-07188-01



21-07188-02



Doyen
24 cm/9½" 21-07190-01





21-07194-04
4 mm



21-07194-06
6 mm



21-07194-08
8 mm



Cobb
24 cm/9½"



21-07194-10
10 mm



21-07194-13
13 mm



21-07194-19
19 mm



21-07194-25
25 mm



21-07198-01
19 cm/7½"
6 mm



21-07199-02
18.5 cm/7¼"
3 mm



21-07201-03
18.5 cm/7¼"
6 mm



21-07203-04
18.5 cm/7¼"
6 mm

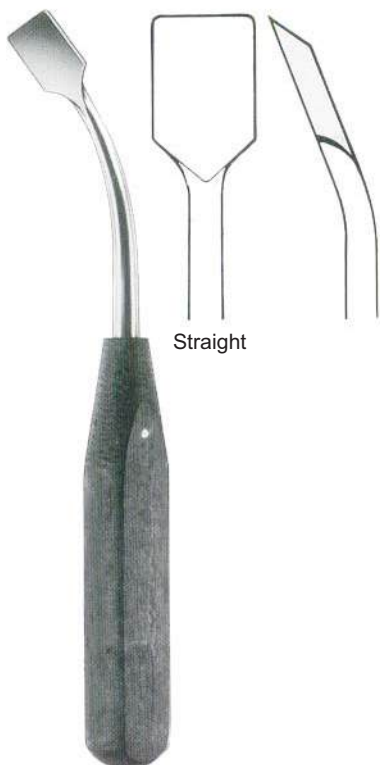

21-07206-05
18.5 cm/7¼"
13 mm



21-07207-06
19.5 cm/7¾"
14 mm



21-07209-07
18.5 cm/7¼"
14 mm



21-07211-08
20 cm/8"
20 mm



21-07214-20
27.5 cm/10³/₄"
20 mm

Wagner
8 mm 21-07218-08 33 cm/13"
17 mm 21-07218-17 33 cm/13"

Cobb
10 mm 21-07222-10 25 cm/10"
13 mm 21-07222-13 25 cm/10"
19 mm 21-07222-19 25 cm/10"
25 mm 21-07222-25 25 cm/10"

Cobb
10 mm 21-07224-10 28 cm/11"
13 mm 21-07224-13 28 cm/11"
19 mm 21-07224-19 28 cm/11"



21-07228-07
16 cm/6¼"
7 mm

21-07228-15
18.5 cm/7¼"
15 mm

21-07228-20
19 cm/7½"
20 mm

Hoen



Yankauer
21-07232-18
18 cm/7"



Langenbeck
21-07236-20
20 cm/8"
8 mm



Langenbeck
21-07238-20
20 cm/8"
10 mm



Langenbeck
21-07240-23
23 cm/9"
11 mm



Mass. Gen. Hosp.
21-07244-15
15 cm/6"



Williger
21-07248-17
17 cm/6¾"
5.5 mm



Williger
21-07250-16
16 cm/6¼"



Quervain
21-07254-20
20 cm/8"



21-07258-16
16 cm/6¼"



Width

Key

6 mm	21-07262-06	19 cm/7½"
12 mm	21-07262-12	19 cm/7½"
19 mm	21-07262-19	19 cm/7½"
25 mm	21-07262-25	19 cm/7½"



König
21-07266-15
15 cm/6"
4.5 mm



König
21-07268-15
15 cm/6"
4.5 mm



Alderdyce
21-07272-21
21 cm/8¼"



McDonald
21-07276-19
19 cm/7½"



Watson-Cheyne
21-07280-19
17.5 cm/7"



Sebilleau
21-07284-17
17 cm/6¾"



21-07288-14
14 cm/5½"
2.8 mm



21-07288-15
15 cm/6"
5 mm



21-07290-15
15 cm/6"
7 mm

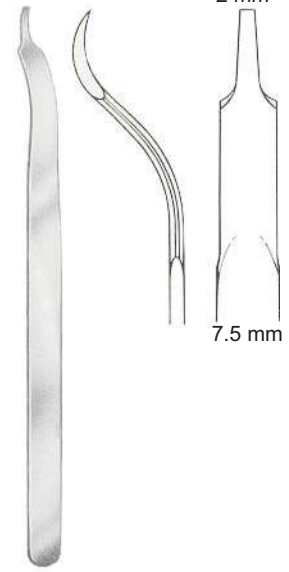

Buck-Gramcko
21-07292-15
15 cm/6"

2 mm
7.5 mm

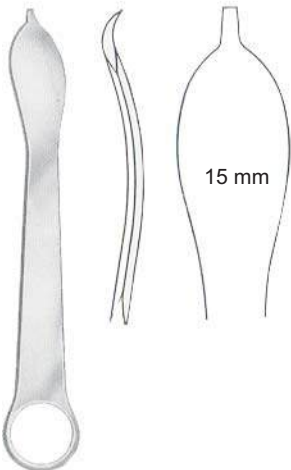

21-07296-12
12.5 cm/5"

2 mm

15 mm



Mini-Hohmann 21-07300-06
16 cm/6¼" 6 mm

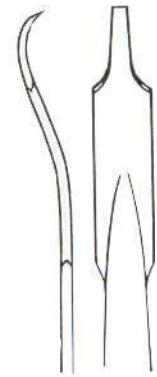

21-07302-08
8 mm

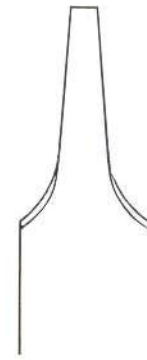

21-07306-17
17 mm

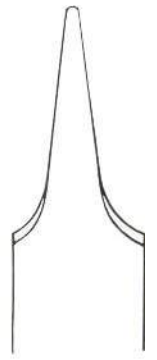

21-07308-17
17 mm



21-07304-26
26.5 cm/10½"
24 mm



Lange-Hohmann
21-07305-26
26 cm/10¼"
22 mm



Hohmann
21-07308-22
22 cm/8¾"
8 mm



Hohmann
21-07308-24
24 cm/9½"
14 mm



Hohmann
21-07308-26
26 cm/10 1/4"
22 mm

Hohmann
21-07308-28
28 cm/11"
33 mm

Hohmann
21-07310-24
24 cm/9 1/2"
43 mm

Hohmann
21-07312-24
24.5 cm/9 3/4"
43 mm

Hohmann
21-07314-24
24 cm/9 1/2"
70 mm

Hohmann
21-07316-22
22 cm/8 3/4"
18 mm



Lange-Hohmann modif			Hohmann-Aldinger	
30 mm	21-07316-26	26.5 cm/10½"	21-07318-27	
33 mm	21-07316-29	29.0 cm/11½"	27 cm/10½"	

Schumacher
(Wagner)
21-07318-34
34.5 cm/13½"

Schumacher
21-07320-29
29 cm/11½"

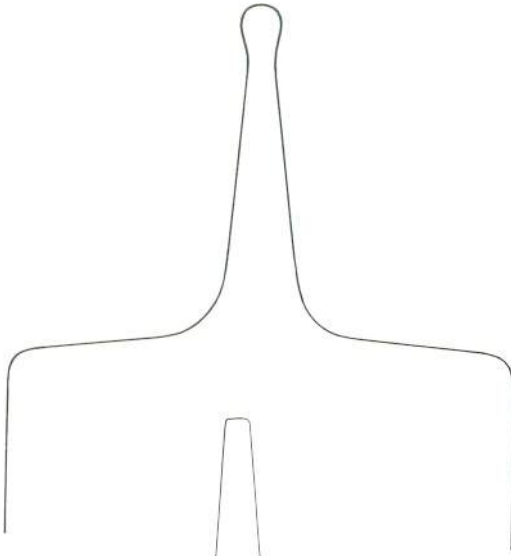

21-07322-25
25.5 cm/10"
65 mm

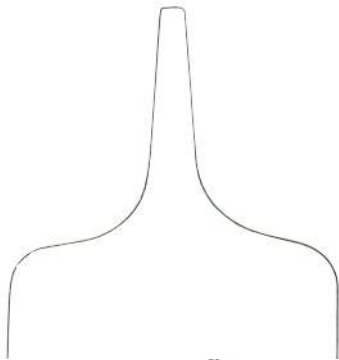

21-07322-24
24 cm/9 "
42 mm



Verbrugge-Muller



Lane Trethowan
21-07324-21
21.5 cm/8½"



Lane
21-07328-25
25.5 cm/10"



Bristow
21-07332-23
23 cm/9"



Murphy-Lane
21-07336-32
32 cm/12½"



Chandler

Length	Width	
18 cm	13 mm	21-07340-13
20 cm	19 mm	21-07340-19
23 cm	25 mm	21-07340-23
25 cm	30 mm	21-07340-30



Blount
21-07344-26
26 cm/10¼"



Blount
21-07346-26
26 cm/10¼"



Bennett 21-07350-44 44 mm
24 cm/9½" 21-07350-64 64 mm



Smillie
14 cm/5½"

- 21-07354-01
32x19 mm
- 21-07354-02
48x19 mm
- 21-07354-03
57x19 mm



21-07356-04
52x13 mm



21-07358-05
12x13 mm

Spinal retractors



- 21-07362-01
75x30 mm
- 21-07362-02
100x30 mm

Taylor
17 cm/6½"



21-07366-21
21.5 cm/8½"

Meniscus retractors



Blount
21-07370-17
17.5 cm/7"



Smillie
21-07374-17
17 cm/6¾"



Smillie
21-07376-17
17 cm/6¾"



Smillie
21-07378-17
17 cm/6¾"



Salenius
21-07382-22
22 cm/8¾"



Salenius
21-07384-22
22 cm/8¾"



21-07388-17
17.5 cm/7"



Neff
21-07392-21
21.5 cm/8½"



Canad-Modell
21-07396-01 20 cm/8"



21-07396-02



Bircher
21-07402-20
20.5 cm/8"





Martin
21-07424-19
19 cm/7½"



Preston
21-07428-18
18 cm/7¼"

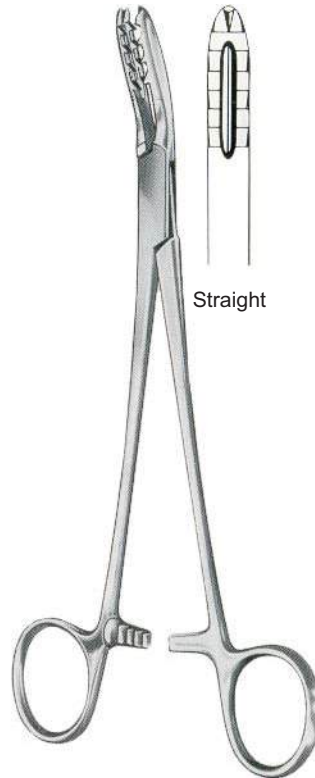

Straight

Bircher-Ganske
21-07432-20
20 cm/8"

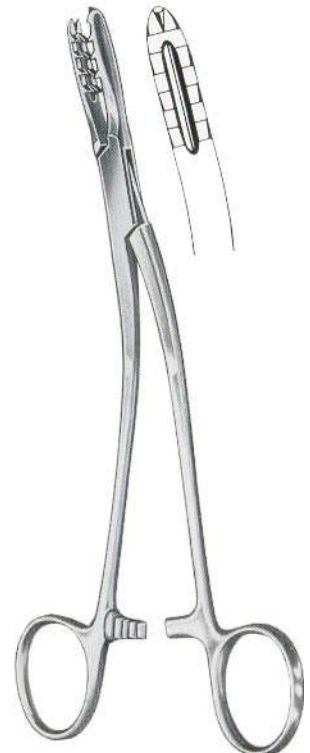

Bircher-Ganske
21-07434-20
20 cm/8"



Lewin
21-07438-17
17.5 cm/7"



Langenbeck
21-07442-21
21 cm/8¼"



Fergusson
21-07446-21
21 cm/8¼"

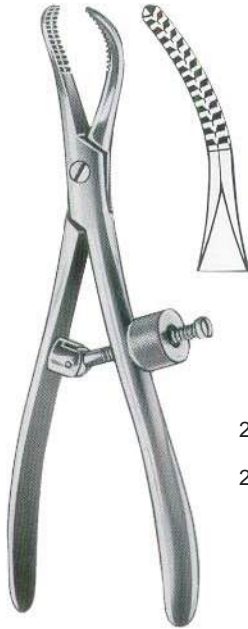

21-07450-16
16 cm/6¼"
21-07450-24
24 cm/9½"

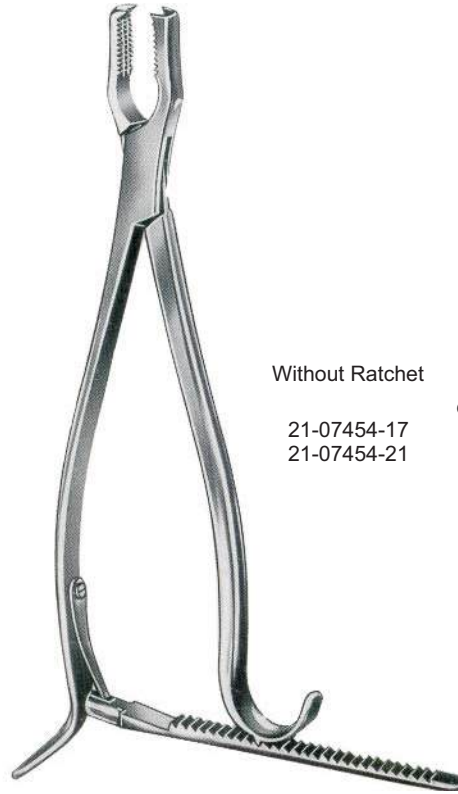

Without Ratchet	Kern		With Ratchet
	cm	in	
21-07454-17	17	6¾"	21-07456-17
21-07454-21	21	8¼"	21-07456-21



21-07460-18	18 cm/07"	21-07461-18
21-07460-23	23 cm/09"	21-07461-23
21-07460-25	25 cm/10"	21-07461-25
21-07460-28	28 cm/11"	21-07461-28



Hey Groves
21-07464-21 21.0 cm/8¼"
21-07464-27 27.0 cm/10½"
21-07464-30 30.5 cm/12"



Semb
21-07468-19
19 cm/7 1/2"



Semb
21-07470-19
19 cm/7 1/2"



Verbrugge
21-07474-17
17.5 cm/7"

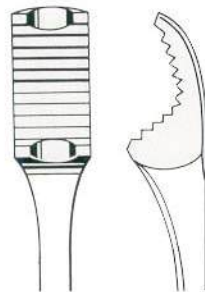

21-07478-25
25 cm/10"

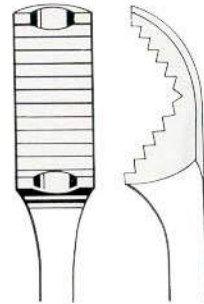

21-07478-26
26 cm/10 1/4"
Verbrugge

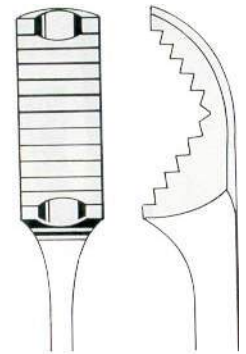

21-07478-27
27 cm/10 1/2"



21-07482-15 15 cm/6"
21-07482-19 19 cm/7½"
21-07482-24 24 cm/9½"
21-07482-26 26 cm/10¼"
21-07482-28 28 cm/11"



Handles Detachable

Percy
21-07486-30

Adjustable



Lambotte
21-07490-22 22 cm/8¾"
21-07490-27 27 cm/10½"
21-07490-30 30 cm/12"



Farabeuf
21-07494-23 23 cm/9"
21-07494-26 26 cm/10¼"



Lambotte
21-07498-22 22.5 cm/9"
21-07498-25 25.5 cm/10½"
21-07498-33 33 cm/13½"



Farabeuf-Lambotte
21-07502-26
26 cm/10¼"



Lambotte
21-07506-19 19 cm/7½"
21-07506-23 23 cm/9"
21-07506-26 26 cm/10¼"



Without Ratchet	Lane	With Ratchet
	cm in	
21-07510-33	33 13"	21-07514-33
21-07510-45	45 17¾"	21-07514-45



21-07518-14
14.5 cm/5¾"



21-07522-12
12 cm/4¾"





Stellbrink
17.5 cm/7"



Bane-Hartmann
21-07563-17
17.5 cm/7"



Mini-Friedmann
21-07567-12
12.5 cm/5"



Friedmann
21-07571-14
14 cm/5½"



Friedmann-Delicate
15 cm/6"



21-07575-15



90°

21-07577-15

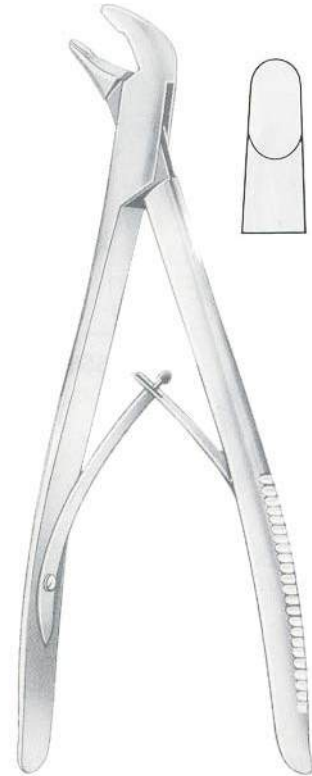

Bacon
21-07580-20
20 cm/8"



Cleveland
21-07583-14 14 cm/5½"
21-07583-17 17 cm/6¾"



Hartmann
21-07587-18
18.5 cm/7¼"



Olivecrona
21-07591-20
20 cm/8"



21-07595-16



21-07597-16

Mead
16.5 cm/6½"



	Lempert	
	cm	in
Straight	16	6¼"
21-07601-16		
21-07601-19	19	7½"
	Curved	
	21-07603-16	
	21-07603-19	



Beyer
21-07607-18
18 cm/7"

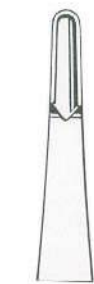

21-07610-17



21-07611-17

Jansen
17.5 cm/7"



21-07615-15



21-07617-15



21-07619-15

Blumenthal
15.5 cm/6"



Hakansson
21-07621-15
15.5 cm/6"



Jansen
21-07623-18
18 cm/7"



Luer
17 cm/6¾"



Straight
21-07626-17

Curved
21-07627-17



Luer
18.5 cm/7¼"

Heavy Pattern

Straight
21-07630-18

Curved
21-07631-18



Luer
15 cm/6"



21-07635-15



21-07637-15



21-07639-15



Adson
20 cm/8"

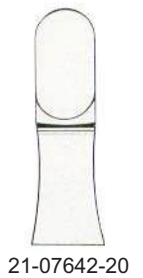

21-07642-20



Kleinert-Kutz
15 cm/6"



21-07645-15
2 mm



21-07647-15
3 mm



Bohler
15 cm/6"



21-07650-15



21-07651-15



**Beyer
Zaufal-Jansen**
18 cm/7"



Zaufal-Jansen
21-07653-18



Beyer
21-07655-18



Mayfield
21-07659-17
17 cm/6³/₄"



Ruskin
21-07663-18
18 cm/7"
Angled



Straight
21-07666-18
18 cm/7"
21-07666-23
23 cm/9"



Ruskin
21-07667-18
18 cm/7"
21-07667-23
23 cm/9"



Marquardt
21-07671-20
20 cm/8"



Rottgen-Ruskin
21-07675-24
24 cm/9½"



21-7679-03
3 mm



21-7679-04
4 mm



21-7679-05
5 mm



21-7681-03
3 mm



21-7681-04
4 mm



21-7681-05
5 mm



Smith-Petersen
24 cm/9½"



Stille-Luer
22 cm/8¾"



Straight
21-07684-22



Curved
21-07685-22



Stille-Luer
27 cm/10½"



21-07688-27



21-07689-27



Semb
21-07693-23
23 cm/9"

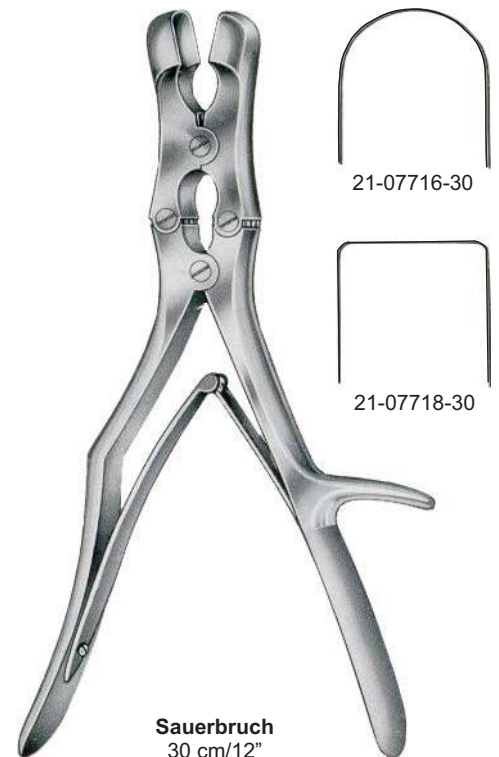



Markwalder
21-07721-20
20 cm/8"



Straight
21-07724-14
21-07724-17
21-07724-19
21-07724-22

cm
14
17
19
22



Curved
21-07725-14
21-07725-17
21-07725-19
21-07725-22

in
5½
6¾
7½
8¾



Littauer-Liston
21-07728-15
15 cm/6"



Cleveland
21-07731-15 15 cm/6"
21-07731-17 17 cm/6¾"



Bohler
15 cm/6"



McIndoe
21-07739-17
17.5 cm/7"



Kazanjian
21-07742-18
18 cm/7"



Ruskin-Liston
18.5 cm/7 1/4"

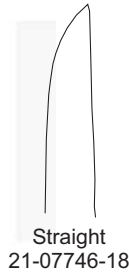

Straight
21-07746-18



Curved on flat
21-07747-18



Stille-Liston
23 cm/9"
27 cm/10 1/2"

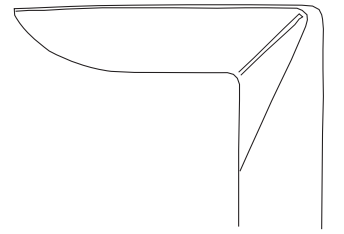

21-07749-27
27 cm/10 1/2"



21-07750-23
21-07750-27

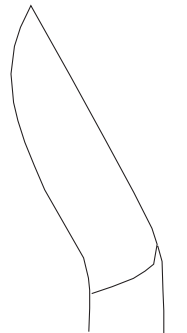

21-07751-23
21-07751-27



Liston-Key (Horsley)
21-07753-27
27 cm/10 1/2"



Semb
21-07755-24
24 cm/9 1/2"



21-07758-13
13.5 cm/5"



18 cm/7"

Forceps for tearing out toe and finger nails



21-07760-18



21-07761-18



21-07762-13
13.5 cm/5 1/4"



Saw blade



21-07764-17
17 cm/6 3/4"

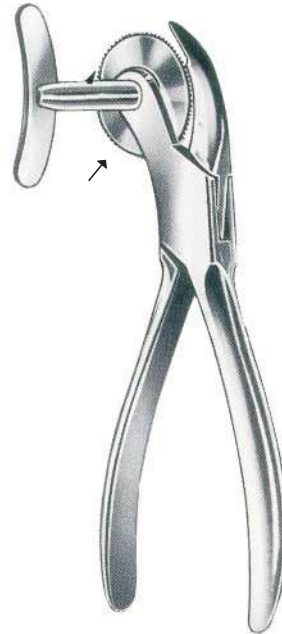

Saw blade

21-07766-17
17 cm/6 3/4"



Langenbeck
21-07768-23
23 cm/9"



Satterlee
21-07770-31
31 cm/12¼"



Charriere
21-07772-27 27 cm/10½"
21-07772-30 30 cm/12"



Spare saw blades
21-07774-12 12 mm
21-07774-15 15 mm
Complete with 2 blades
21-07774-35

Charriere



Spare saw blades
21-07776-43 3 mm
21-07776-45 5 mm
21-07776-47 7 mm
Complete with 3 blades
21-07776-39

Helferich-Bier



Hudson
21-07778-00
Hand drill, with 4 burrs, fig. 1-4

Handle, only
21-07778-10

Conical and spherical burrs, single

Flat trephine

Extension piece



Fig. 1
21-07778-01
9 mmØ



Fig. 2
21-07778-02
14 mmØ



Fig. 3
21-07778-03
16 mmØ



Fig. 4
21-07778-04
22 mmØ



Cushing
Fig. 5
21-07778-05
14 mmØ

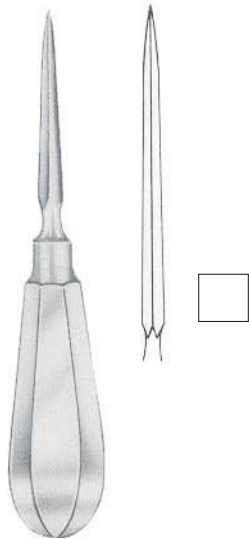

Fig. 6
21-07778-06

Drill guide and dura protecting forceps



Adson
21-07780-15
15 cm/6"



21-07784-14
14 cm/5½"



Perthes
21-07786-21
21 cm/8¼"

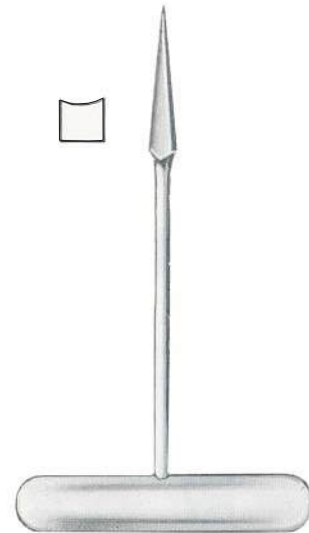

21-07788-14
14 cm/5½"



21-07792-14
14 cm/5½"



21-07794-16
16 cm/6¼"



18cm/7"

Pinsmed TC



21-07798-01



21-07798-02



21-07798-03



21-07798-04



21-07798-05

Pinsmed TC



21-07802-18 18 cm/7"
21-07802-20 20 cm/8"

Pinsmed TC



21-07806-16
15 cm/6"

21-07806-20
20 cm/8"



21-07810-16
15 cm/6"





21-07814-13 13 cm/5"
21-07814-18 18 cm/7"



21-07818-17
17 cm/6¾"



21-07822-15
15.5 cm/6"



21-07826-17 17 cm/6¾" 21-07828-17

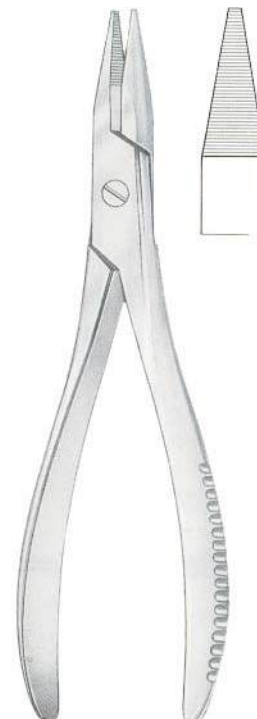

21-07830-19
19 cm/7 ½"



For soft wire
with a diam. of max.

21-07834-15
15 cm/6"
2.0 mm

21-07836-18
18.5 cm/7¼"
1.7 mm

21-07837-16
16 cm/6¼"
2.0 mm

For hard wire
with a diam. of max.

1.5 mm

1.7 mm

2.0 mm

PinsmedTC



21-07840-12
0.7 mm
0.5 mm
12 cm/4¾"



21-07844-15
2.0 mm
1.0 mm
15 cm/6"



21-07848-18
2.0 mm
1.7 mm
18 cm/7"



21-07852-18
2.5 mm
1.5 mm
18.5 cm/7¼"



21-07856-18
2.0 mm
1.7 mm
18 cm/7"



21-07860-22
3.0 mm
2.5 mm
22 cm/8¾"



21-07864-22
3.0 mm
22 cm/8¾"



With 1 Pin

Bohler

cm	in	
h x b	h x b	For Arm
16 x 9	6¼ x 3½	21-07868-16

		For Thigh and Knee
21 x 11	8¼ x 4½	21-07868-21

With 3 Traction Hooks



Kirschner

Clear Width	cm	in
21-07872-01	9.5x7	3¾x2¾
21-07872-02	10.5x10.5	4¼x4¼
21-07872-03	12x12	4¾x4¾
21-07872-04	15.5x15.5	6x6
21-07872-05	20x15.5	8x6

With 3 Traction Hooks



Kirschner

21-07880-01	Small Pattern
21-07880-02	Medium Pattern
21-07880-03	Large Pattern



Clear Width

	cm	in
21-07876-18	18x10	07x04
21-07876-27	27x16	10½x06¼

Screw Nut Wrench



21-07884-10
10 cm/4"

Screw Driver



21-07884-12
12 cm/4¾"

Wire Strainer



21-07884-20
20 cm/8"

Fixation Discs For Drill Wires



21-07884-30
Pair



21-07884-40



21-07884-42

Fixation Discs



21-07884-51
Pair

Bone Wire Guides



Bone Wire Tighteners

Loute
21-07888-00
21 cm/8 1/4"



Demel

Bone Wire Guides
Fig. 1 21-07892-01
Fig. 2 21-07892-02
Fig. 3 21-07892-03

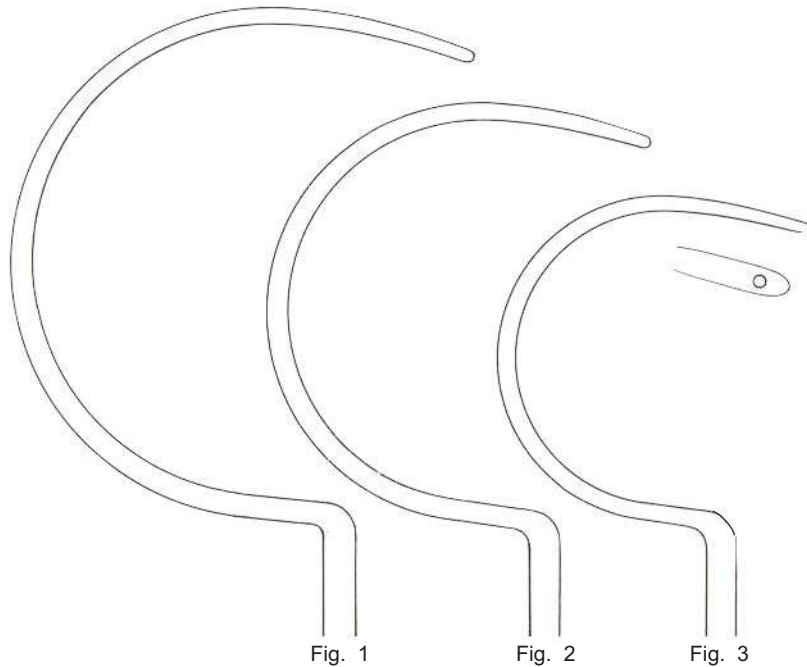



100 g 21-07896-10
350 g 21-07896-35
500 g 21-07896-50
700 g 21-07896-70

22 cm/8½"

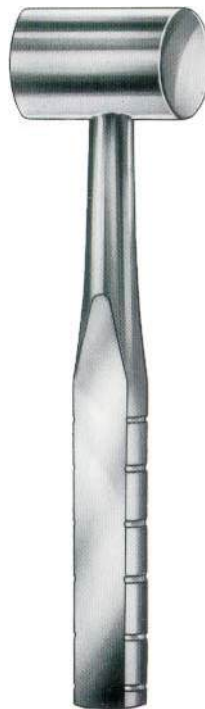

Heath
21-07900-18
18 cm/7" Ø 40 mm

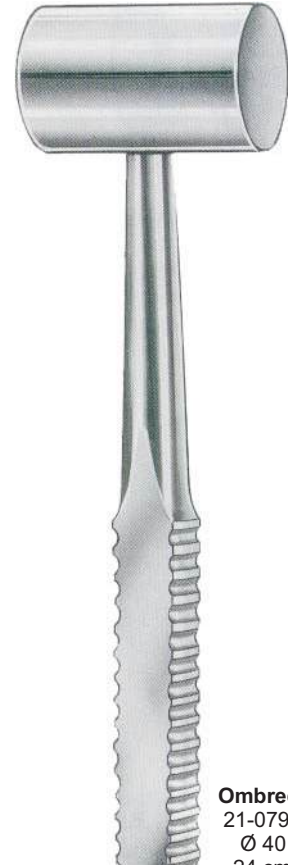

Ombredanne
21-07904-24
Ø 40 mm
24 cm/9½"
550 g



1 Side Flat
1 Side Convex

Cottle
21-07908-19
Ø 30 mm
19 cm/7½"
350 g



Williger
21-07912-23
23 cm/9"
150 g



Hajek
21-07916-21
Ø 27 mm
21 cm/8¼"
140 g



165 g
Ø 22 mm

21-07920-19
19 cm/7½"

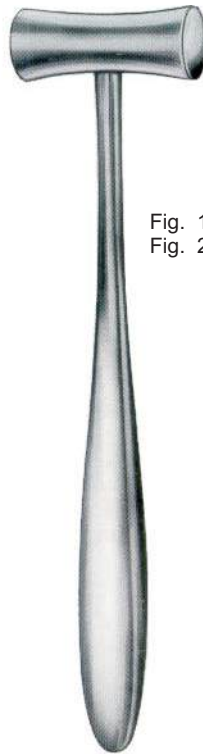
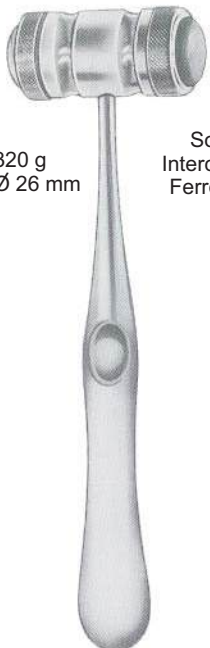

Fig. 1 21-07924-19 19mm Ø
Fig. 2 21-07924-25 25mm Ø

Lucae
19 cm/7½"



21-07928-16
16.5 cm/6½"



320 g
Ø 26 mm

Solid With
Interchangeable
Ferrozell Jaws

Mead
21-07932-17
17 cm/6¾"



280 g
Solid Steel

Gardner
21-07936-14
14 cm/5½"



200 g
22 mm Ø
(7 oz.)

Partsch
21-07940-18
18 cm/7"



Gerzog
21-07944-19
19 cm/7½"



7 mm Ø



Spare Screw

21-07948-34
34cm/13½"

Tendon Passing Instruments



Malleable

Bunnell
21-07950-18 18cm/7"
21-07950-23 23cm/9"

Tendon Strippers



mm Ø
4.0 21-07952-40
4.5 21-07952-45
5.5 21-07952-55
Flexible Shaft

Bunnell
23cm/9"



Fischer
21-07956-31
31 cm/12¼"



Brand

21-07960-50
50 cm/19½"
06 mm Ø



21-07962-30
30 cm/12"
03 mm Ø

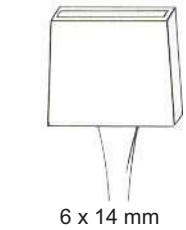

Brand
21-07964-50
50 cm/19½"

6 x 14 mm



Steinmann
21-07968-16
16 cm/6¼"

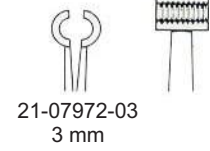

Larsen
10 cm/4"

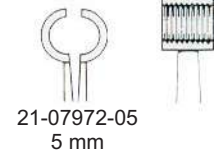

Kleinert-Kutz
21-07976-20
20 cm/8"

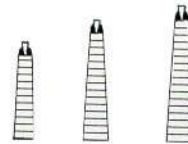

Brand
21-07980-15 15 cm/6"
21-07980-19 19 cm/7½"
21-07980-24 24 cm/9½"



Brand
21-07981-15 15 cm/6"
21-07981-19 19 cm/7½"
21-07981-24 24 cm/9½"



21-07984-20



21-07985-20

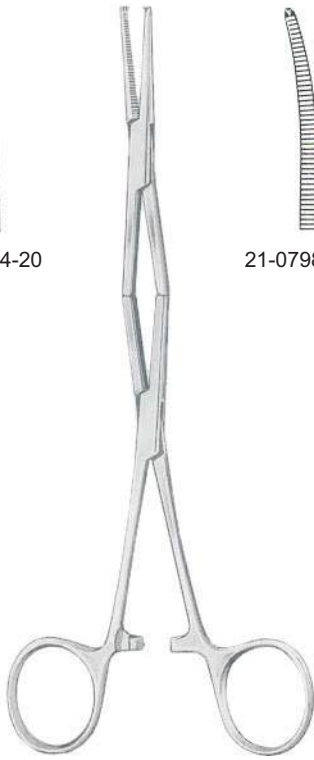

20 cm/8"

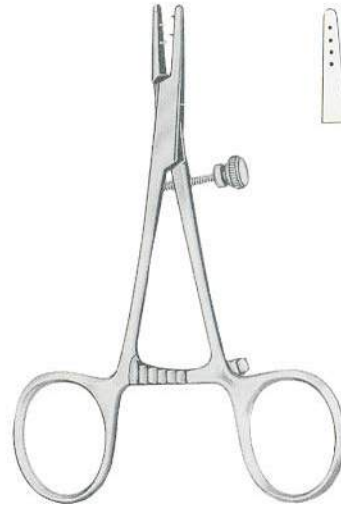

Steinmann
21-07988-13
13 cm/5"

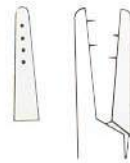

Caroll
21-07992-11
11 cm/4½"

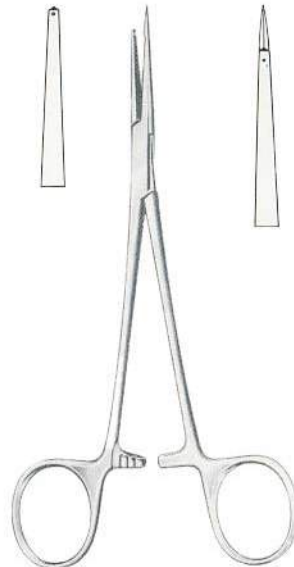
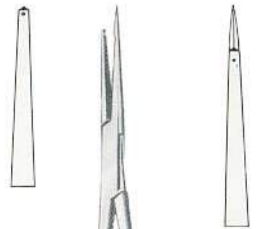

21-07996-15
15 cm/6"



21-07997-15
15 cm/6"



Laborde
22-08000-13 13 cm/5"
22-08000-15 15 cm/6"



Trousseau
22-08004-14
14 cm/5½"



Trousseau-Baby
22-08006-13
13 cm/5"

Hooks

Left

Right

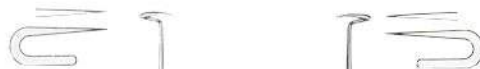

Sharp



Bose
22-08010-07
7 cm/2¾"



22-08013-16



22-08015-16

Bose
16 cm/6¼"



Thyroid Gland Retractor











Trachea Trocars



Schoenborn
22-08018-21
21 cm/8¼"

Uckerman

22-08022-08 08 mm Ø
22-08022-10 10 mm Ø
13 cm/5"

Fig	0	1	2	3	4	5	6	7	8	9
										
Ø mm	04	05	06	07	08	09	10	11	12	13
Charr./Fr.	12	15	18	21	24	27	30	33	36	39
	45	50	55	60	65	70	75	80	85	90

Length of Outer Tube

Standard Pattern



Luer

Fig.	mm Ø	
0	4	22-08026-04
1	5	22-08026-05
2	6	22-08026-06
3	7	22-08026-07
4	8	22-08026-08
5	9	22-08026-09
6	10	22-08026-10
7	11	22-08026-11
8	12	22-08026-12
9	13	22-08026-13



Chevalier-Jackson



Fig.	mm Ø	
0	4	22-08028-04
1	5	22-08028-05
2	6	22-08028-06
3	7	22-08028-07
4	8	22-08028-08
5	9	22-08028-09
6	10	22-08028-10
7	11	22-08028-11
8	12	22-08028-12
9	13	22-08028-13



Luer

Fig.	mm Ø	
4	8	22-08030-08
5	9	22-08030-09
6	10	22-08030-10
7	11	22-08030-11
8	12	22-08030-12
9	13	22-08030-13



Goitre Probes

Kocher

23-08034-15 15 cm/6"
23-08034-16 16 cm/6¼"



Goitre Grasping Forceps

Lahey

23-08038-15 15 cm/6"
23-08038-20 20 cm/8"



Muscle Forceps

23-08042-17

Mastin
17 cm/6¾"

Comedone Extractors



Schamberg
24-08046-10
10 cm/4"



Unna
24-08050-14
14 cm/5½"



Unna
24-08052-14
14 cm/5½"



Sealfeld
24-08056-10
10 cm/4"



Saalfeld
24-08060-14
14 cm/5½"



Katsch
24-08064-14
14 cm/5½"

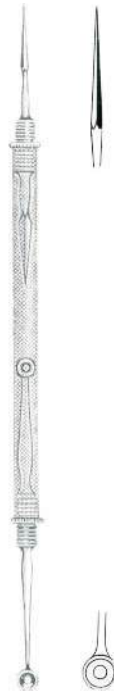

Hebra
24-08068-18
18 cm/7"



Piffard
14.5cm/5¾"

Skin Currettes



Fig. 1 24-08072-01

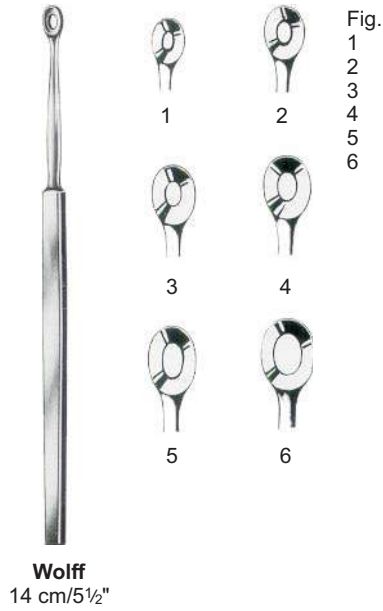

Fig. 2 24-08072-02

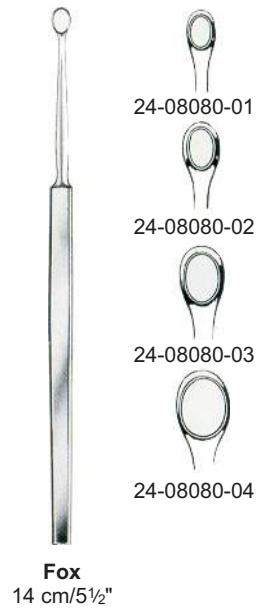

Fig. 3 24-08072-03

Lupus Currettes



Lupus Currettes



Lupus Scraper



Moncorps Knife



Cutaneous Hook

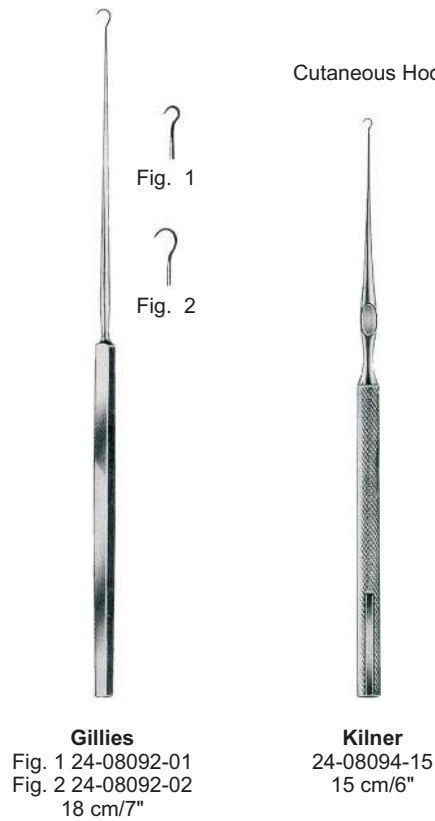



Allis

cm	in	4 : 5	5 : 6
15	6"	25-08096-15	25-08100-15
19	7½"		25-08100-19
23	9"		25-08100-23
25	10"		25-08100-25

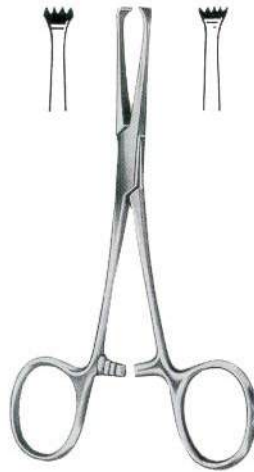

Baby-Allis

25-08104-12	12 cm/4¾"
25-08104-14	14 cm/5½"



Allis-Atrauma

25-08108-16	16 cm/6¼"
25-08108-20	20 cm/8"
25-08108-25	25 cm/10"
25-08108-30	30 cm/12"



Allis-Adair
25-08112-15
15 cm/6"



Baby-Allis
25-08116-15
15 cm/6"



Lockwood-Allis
25-08120-16 16 cm/6¼"
25-08120-20 20 cm/8"



Thoms-Allis
25-08124-20
20 cm/8"



Judd-Allis
25-08128-15 15 cm/6"
25-08128-19 19 cm/7½"



Littlewood
25-08132-18
18.5 cm/7¼"



Williams
25-08136-16
16 cm/6¼"



Lockwood
25-08140-20
20 cm/8"

Pinsmed Atrauma



cm/in **Babcock-Atrauma**
16 cm/6¼" 25-08144-16
18 cm/7" 25-08144-18
20 cm/8" 25-08144-20
24 cm/9½" 25-08144-24



Babcock(Standard)
25-08148-16
25-08148-18
25-08148-20
25-08148-24



Baby-Babcock
25-08152-16



Babcock
25-08156-16
25-08156-20

PinsmedTc

Pinsmed Atrauma

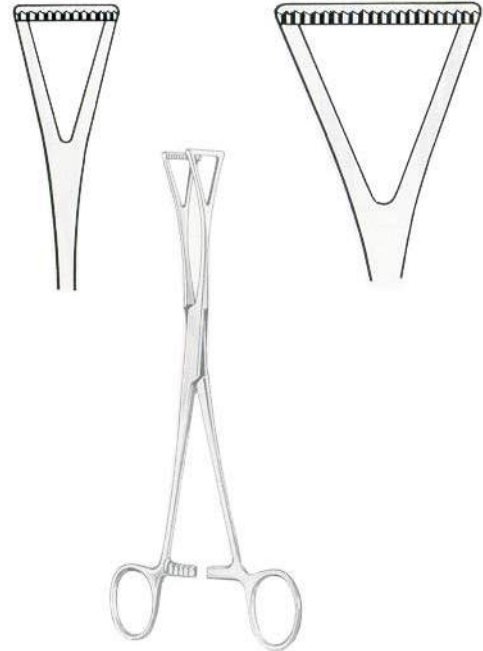

Duval			
	cm	in	
25-08164-18	18	7"	
25-08164-20	20	8"	25-08168-20
25-08164-23	23	9"	25-08168-23

PinsmedTC



Duval
25-08172-20
20 cm/8"

Child
24 cm/9½"



Pinsmed Atrauma





Baby-Doyen
Straight 25-08186-18 18 cm/7"
Curved 25-08187-18 18 cm/7"

Doyen
Straight 25-08190-21 21 cm/8¼"
25-08190-23 23 cm/9"
Curved 25-08191-21 21 cm/8¼"
25-08191-23 23 cm/9"

Scudder
25-08194-25 25 cm/10"

Pinsmed Atrauma

Straight



Doyen-Atrauma

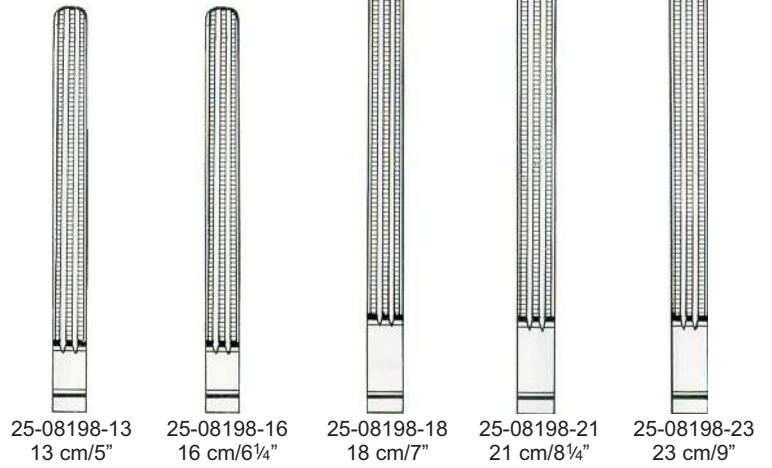

Pinsmed Atrauma

Curved

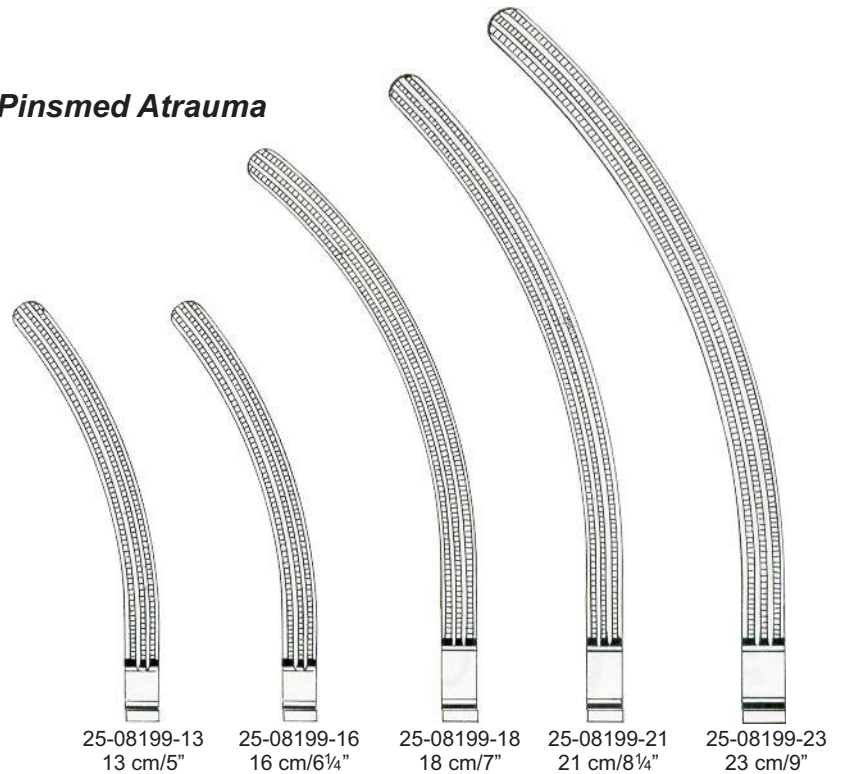



Mayo-Robson
Mayo-Robson Atrauma

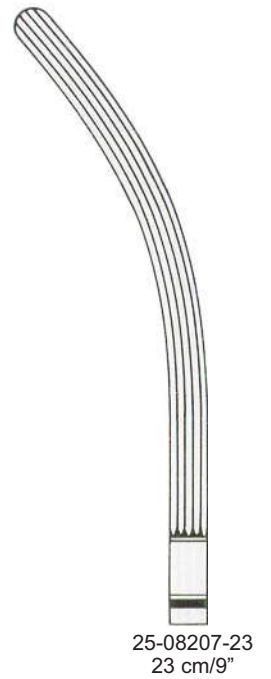
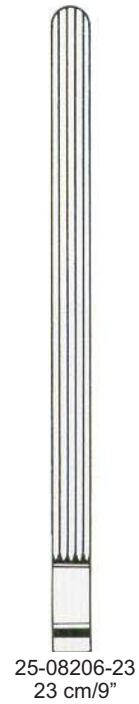
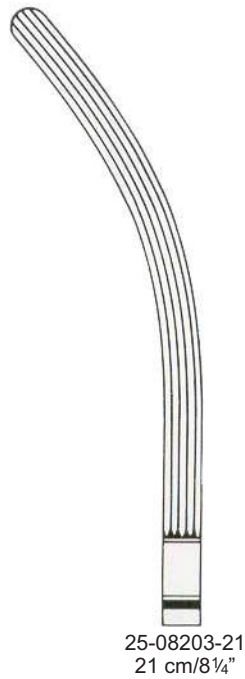
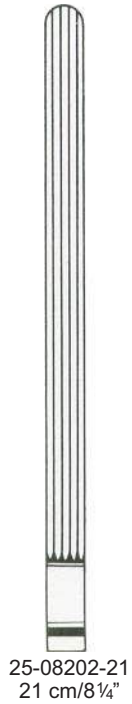

Pinsmed Atrauma

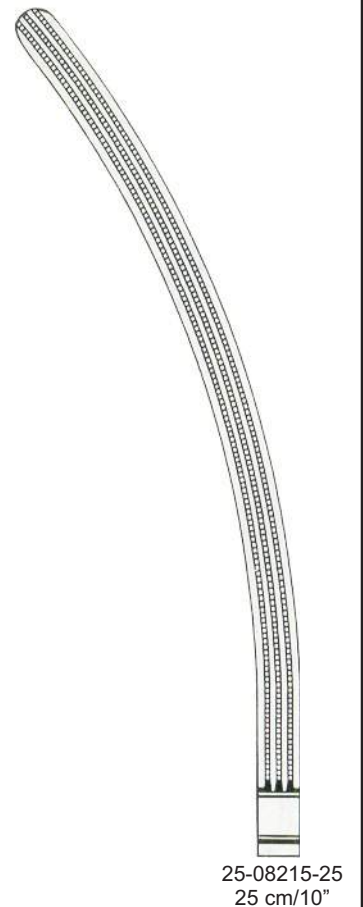
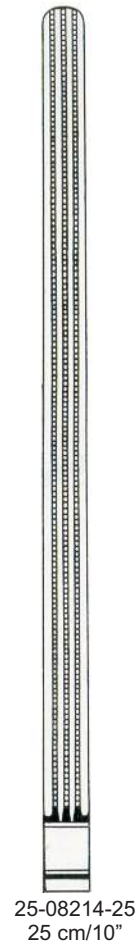
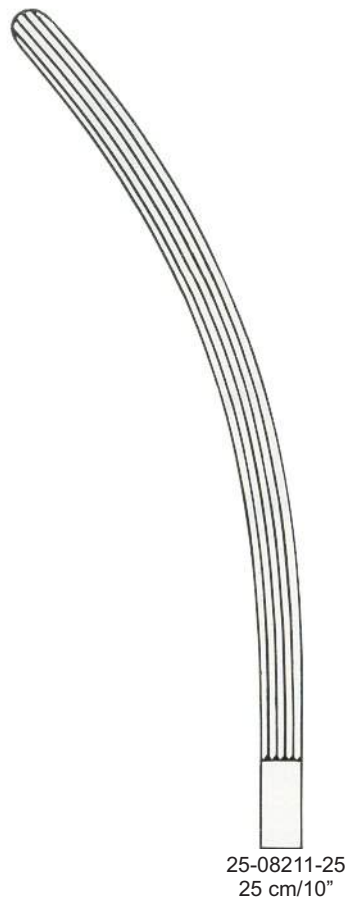
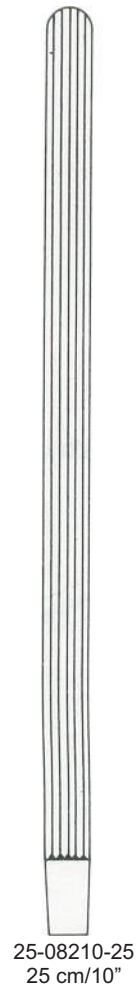

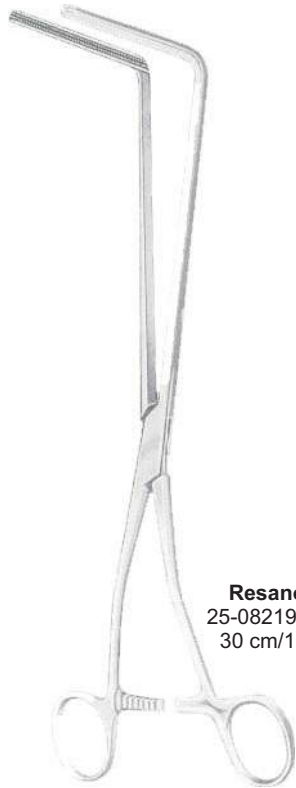

Resano
25-08219-30
30 cm/12"



Hayes



25-08223-26
26 cm/10¼"

Pinsmed Atrauma

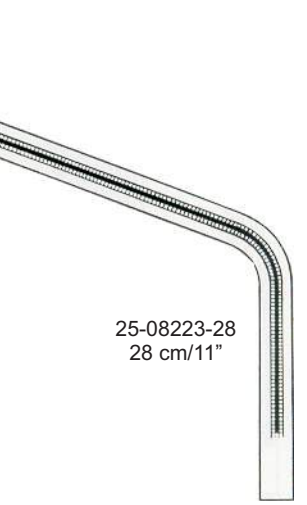

25-08223-28
28 cm/11"

Pinsmed Atrauma



Fehland
25-08227-24
24 cm/9½"



Brunner
24 cm/9½"

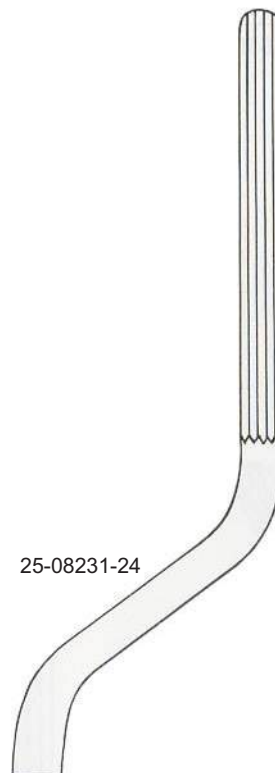

25-08231-24



25-08233-24



Straight **Baby-Kocher** Curved
25-08236-13 25-08237-13
13 cm/5" 13 cm/5"



Kocher



25-08240-22
22 cm/8³/₄"



25-08240-25
25 cm/10"



25-08240-28
28 cm/11"



25-08241-22
22 cm/8³/₄"



25-08241-25
25 cm/10"

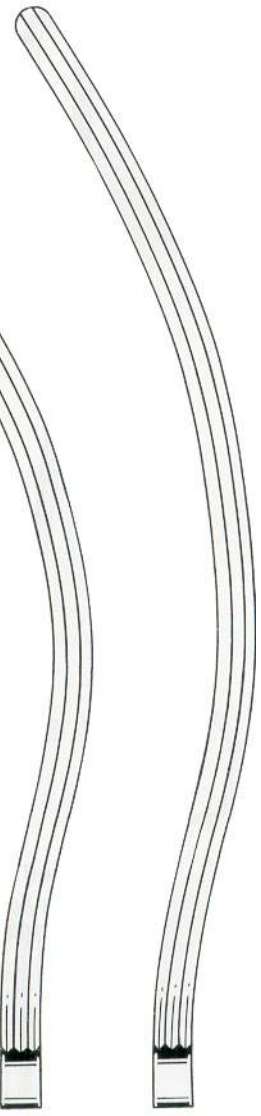

25-08241-28
28 cm/11"

Pinsmed Atrauma



Kocher-Atrauma



25-08244-22
22 cm/8¾"

25-08244-25
25 cm/10"

25-08244-28
28 cm/11"

25-08245-22
22 cm/8¾"

25-08245-25
25 cm/10"

25-08245-28
28 cm/11"



Pylorus spreader

Benson
25-08252-15
15.5 cm/6"



Nussbaum
25 cm/10"

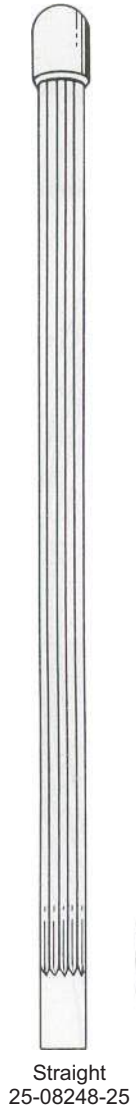

Straight
25-08248-25

Curved
25-08249-25



Allen
25-08253-15 15.5 cm/6"
25-08253-20 20.0 cm/8"



Kleinschmidt
25-08255-12
12 cm/4¾"

Blindgut forceps



Payr
(Payr-Baby)

For children



25-08258-15
15 cm/6"

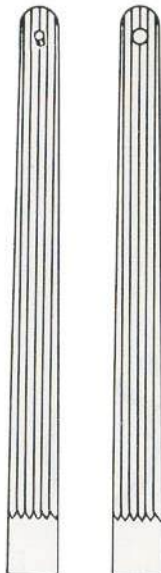

25-08258-21
21 cm/8¼"



25-08258-29
29 cm/11½"

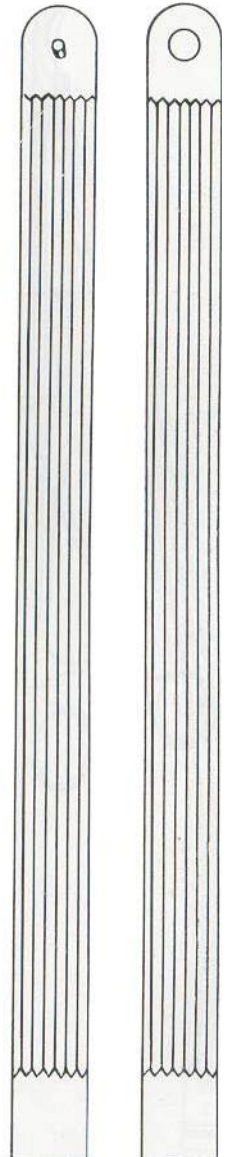

25-08258-35
35 cm/13¾"



Lane
30 cm/12"



Twin Clamps Forceps



Straight
25-08862-30

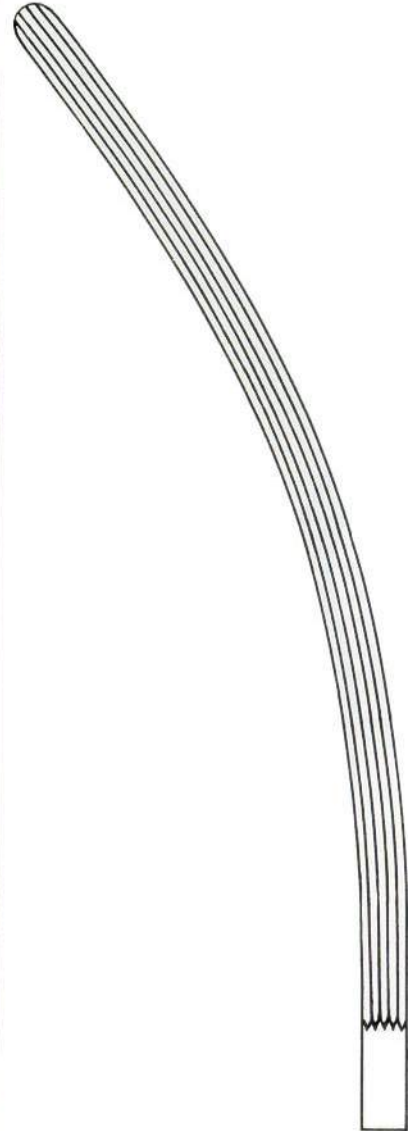

Curved
25-08863-30

Pinsmed Atrauma



**Scudder
Scudder-Atrauma**
33 cm/13"



Straight
25-08266-33

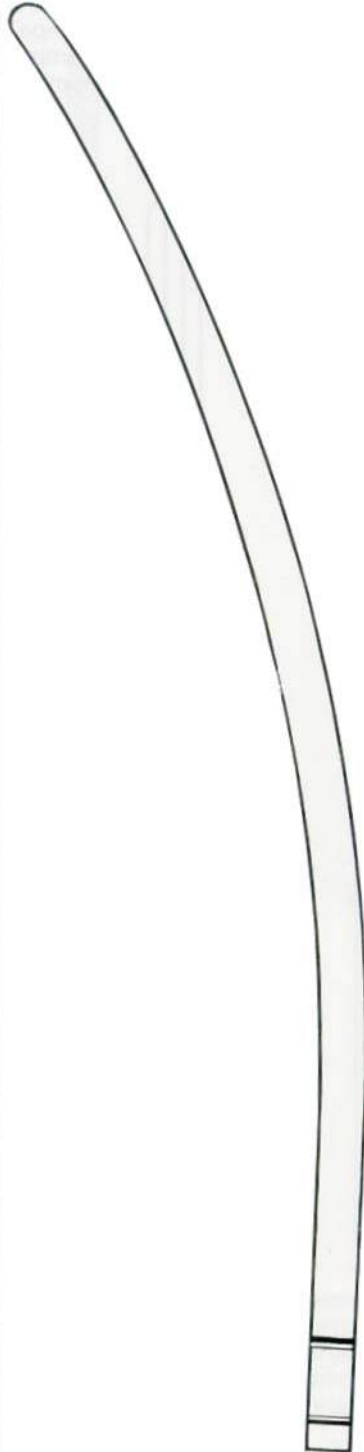

Curved
25-08267-33



Straight
25-08270-33

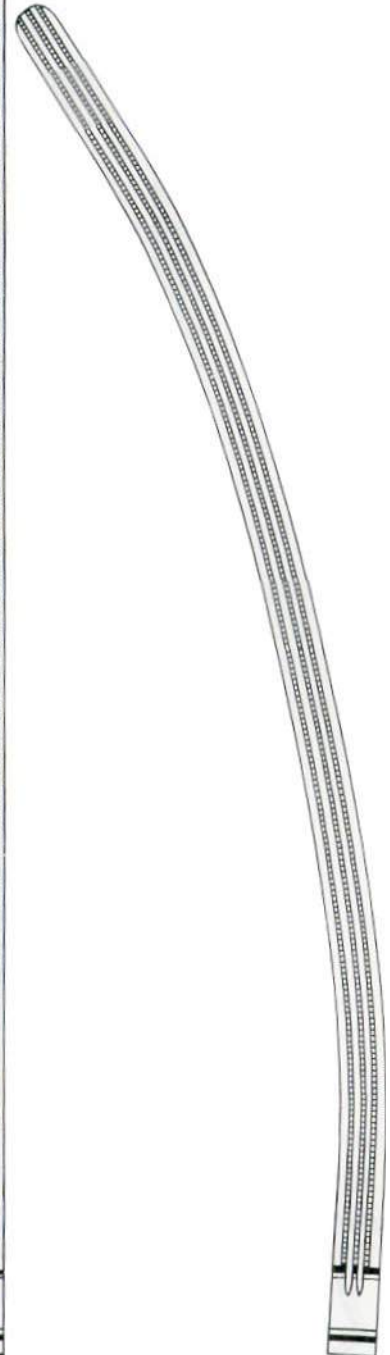

Curved
25-08271-33

Intestinal and Stomach Twin Clamps



Haberer
25-08274-36
36 cm/14"

Straight
25-08278-30

Nussbaum
30 cm/12"

Curved
25-08279-30



Czerny
25-08282-22
22 cm/8¾"



Pratt
25-08286-20
80 x 25 mm
20.5 cm/8"



Sims
25-08291-15

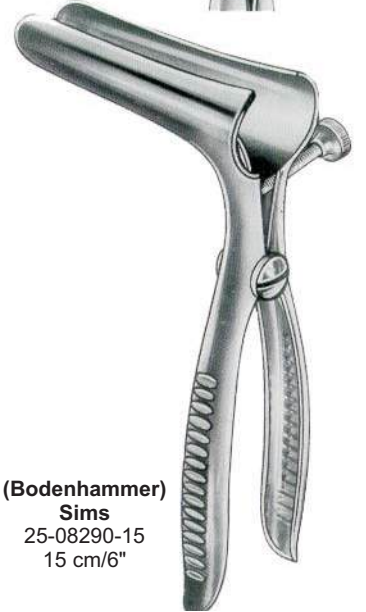

(Bodenhammer) Sims
25-08290-15
15 cm/6"



Sims
22 cm/8¾"



Mathieu
25-08298-19
90 x 15 mm
19.5 cm/7¾"

Length of Blades

- | | |
|-------------|--------|
| 25-08294-06 | 60 mm |
| 25-08294-08 | 80 mm |
| 25-08294-12 | 125 mm |
| 25-08294-15 | 150 mm |



Barr
25-08302-17
17 cm/6¾"
70 X 22 mm



Smith-Bule
25-08306-15
15 cm/6"

Anuscopes



Hirschmann
25-08310-01
25-08310-02
25-08310-03
25-08310-04

Fig. 1 16 mm Ø x 65 mm
Fig. 2 19 mm Ø x 65 mm
Fig. 3 22 mm Ø x 65 mm
Fig. 4 25 mm Ø x 65 mm



Bensaude
25-08314-01
25-08314-02

Fig. 1 19 mm Ø x 70 mm
Fig. 2 22 mm Ø x 70 mm

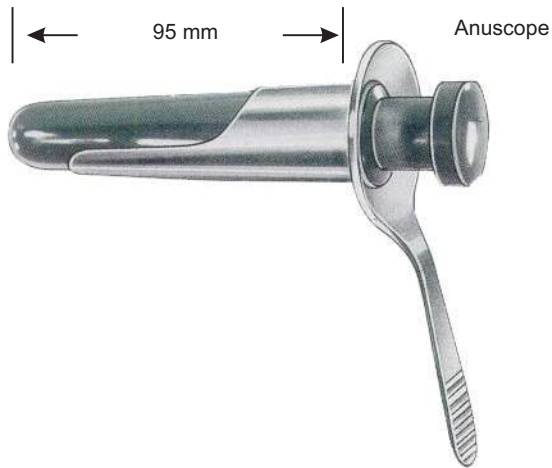

Ives-Fansler
25-08318-22
22 mm Ø

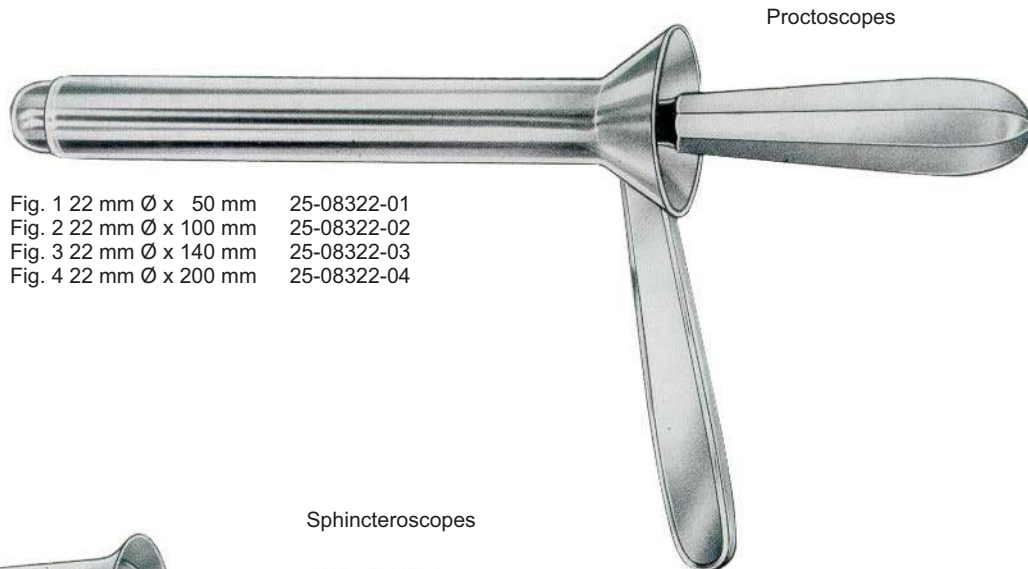

Fig. 1 22 mm Ø x 50 mm	25-08322-01
Fig. 2 22 mm Ø x 100 mm	25-08322-02
Fig. 3 22 mm Ø x 140 mm	25-08322-03
Fig. 4 22 mm Ø x 200 mm	25-08322-04

Kelly



Kelly

Fig. 1 21 mm Ø 50 mm	25-08326-01
Fig. 2 27 mm Ø 50 mm	25-08326-02

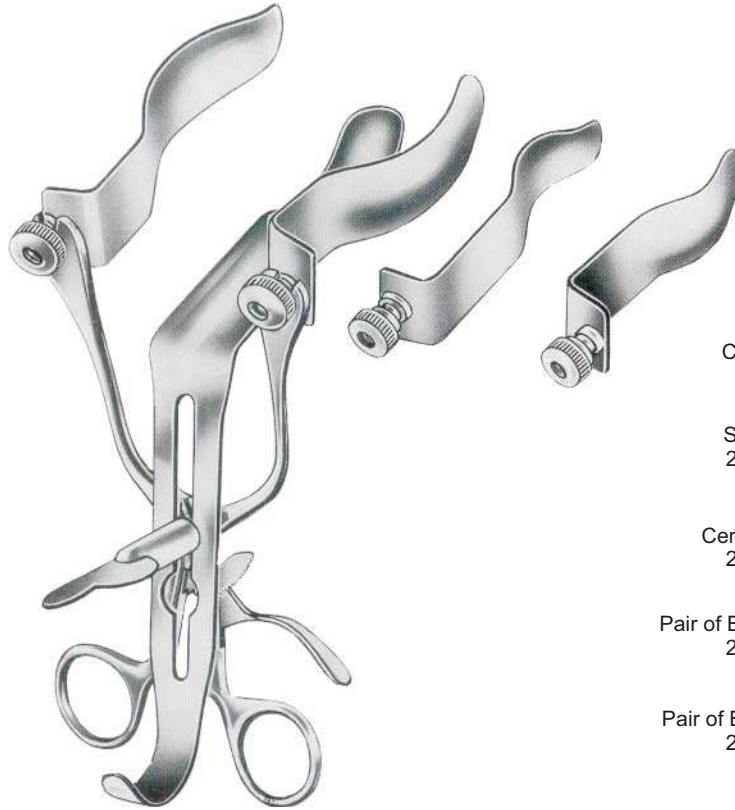

Park
25-08330-00
14.5 cm/5¾"

Consisting of:

Spreader only
25-08330-01

Center Blade only
25-08330-02

Pair of Blades Only 75 mm
25-08330-03

Pair of Blades only 95 mm
25-08330-04



Park
25-08334-00
13 cm/5"

Consisting of:

Spreader only
25-08334-01

Pair of Blades only 95 mm
25-08334-02

Length of Shaft

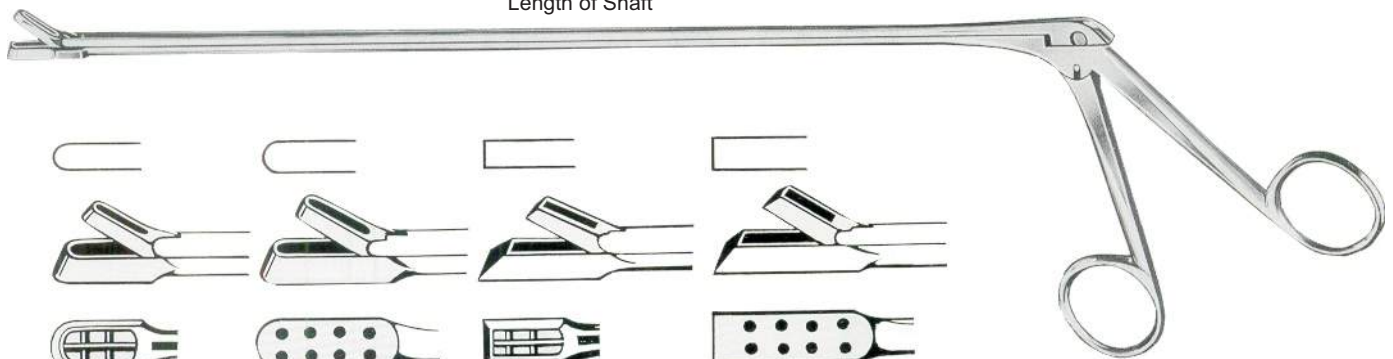



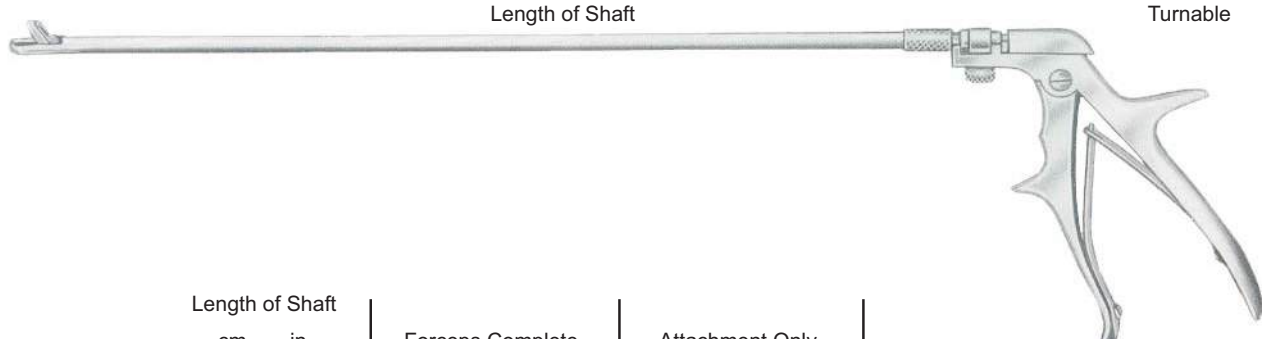

		cm	in	
1	2	28	11	Yeoman
25-08338-28	25-08340-28	35	13 ³ / ₄ "	
25-08338-35	25-08340-35	42	16 ¹ / ₂ "	
25-08338-42	25-08340-42			
3	4			
25-08342-28	25-08344-28			
25-08342-35	25-08344-35			
25-08342-42	25-08344-42			

Length of Shaft

Turnable



	Length of Shaft		Forceps Complete	Attachment Only
	cm	in		
	33	13	25-08348-33	25-08358-33
	40	16	25-08348-40	25-08358-40
	33	13	25-08350-33	25-08360-33
	40	16	25-08350-40	25-08360-40
	33	13	25-08352-33	25-08362-33
	40	16	25-08352-40	25-08362-40
	33	13	25-08354-33	25-08364-33
	40	16	25-08354-40	25-08364-40

**Yeoman
(Turrell)**
Handle Only
25-08348-00

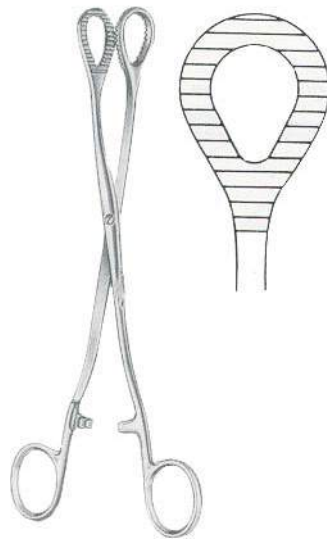

Heywood-Smith
25-08366-21
21 cm/8¼"



Heywood-Smith
25-08368-21
21 cm/8¼"

Rectal Snare

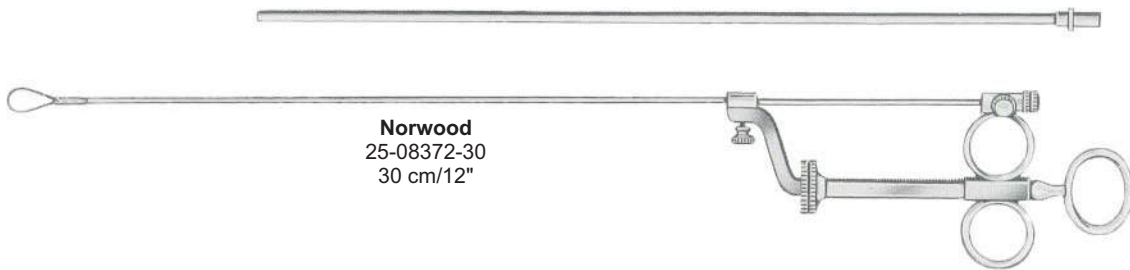

Norwood
25-08372-30
30 cm/12"

Rectal Aspiration Cannula

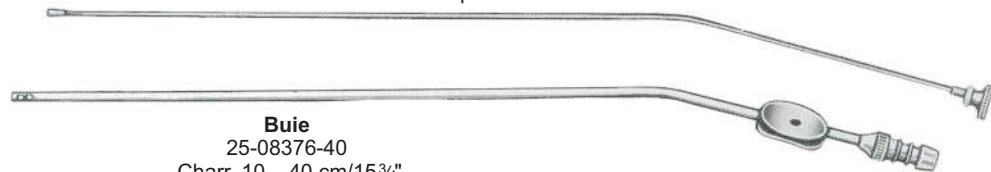

Buie
25-08376-40
Charr. 10. 40 cm/15¾"

Rectal Coolers



25-08380-01



25-08380-02



Aspiration Tip

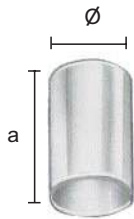

	a	∅
25-08384-11	11 mm	10 mm
25-08384-16	16 mm	10 mm

Charging Cone



10 mm ∅

25-08392-10

Charging Cone



12 mm ∅

25-08392-12

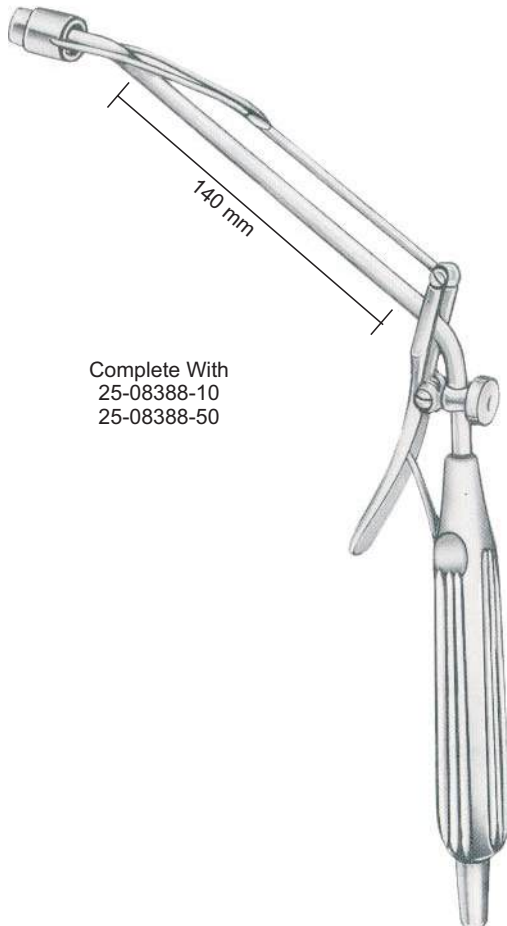

Complete With
25-08388-10
25-08388-50



Complete With
25-08396-00
25-08396-50

Rudd
31.5 cm/12½"

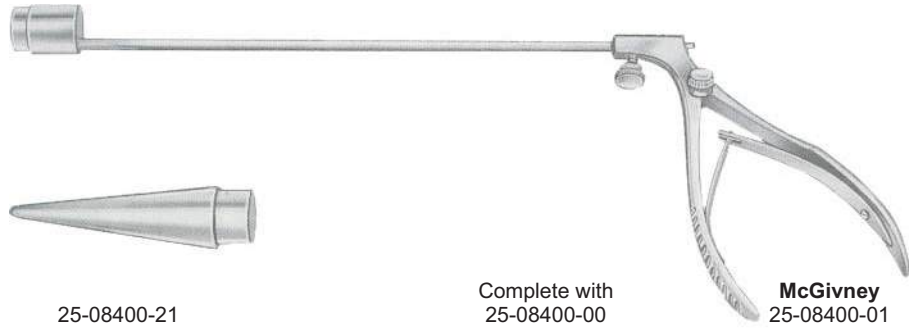

25-08400-21

Complete with
25-08400-00

McGivney
25-08400-01

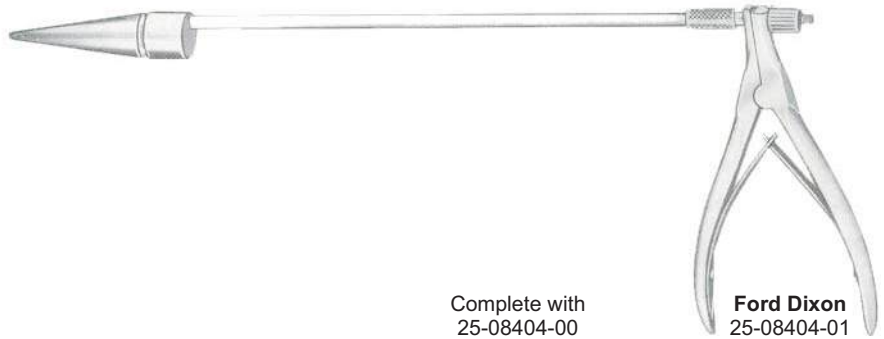

Complete with
25-08404-00

Ford Dixon
25-08404-01

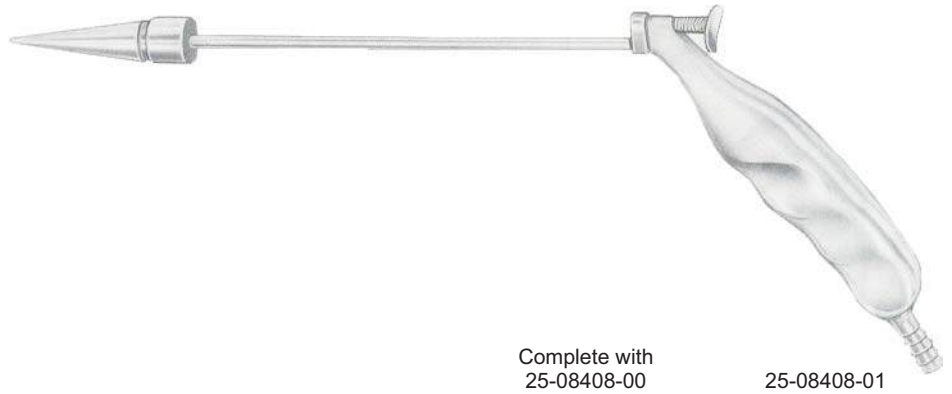

Complete with
25-08408-00

25-08408-01



McGivney
25-08412-19
19 cm/7 1/2"



25-08414-00
Ligator rubber rings
in box of 100 pieces



Guyon



26-08416-20
20 cm/8"

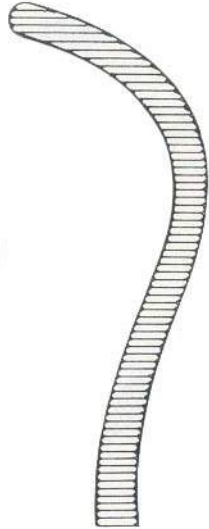

26-08416-22
22 cm/8¾"

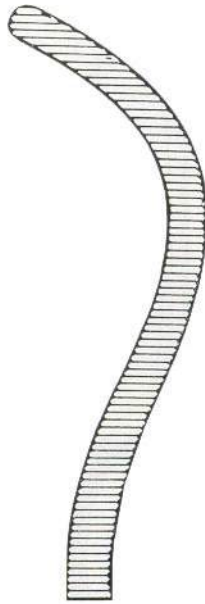

26-08416-24
24 cm/9½"



26-08418-23
23 cm/9"



26-08418-24
24 cm/9½"

Pinsmed Atrauma



Guyon
26-08420-23
23 cm/9"



Herrick
26-08424-23
23 cm/9"



Mayo-Guyon
26-08428-23
23 cm/9"



Stille
26-08432-23
23 cm/9"



Elsasser
26-08436-20
20 cm/8"

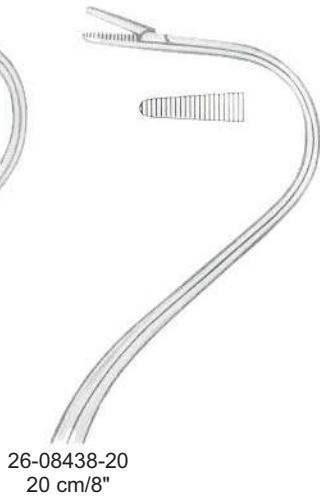

26-08438-20
20 cm/8"

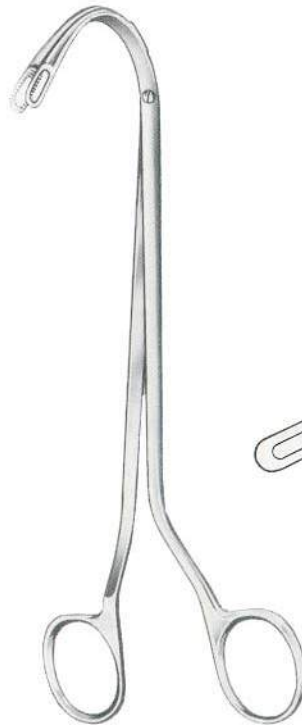

Randall

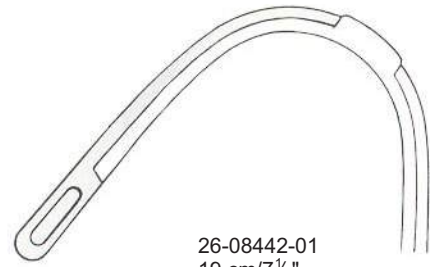

26-08442-01
19 cm/7½"



26-08442-02
19 cm/7½"



Randall

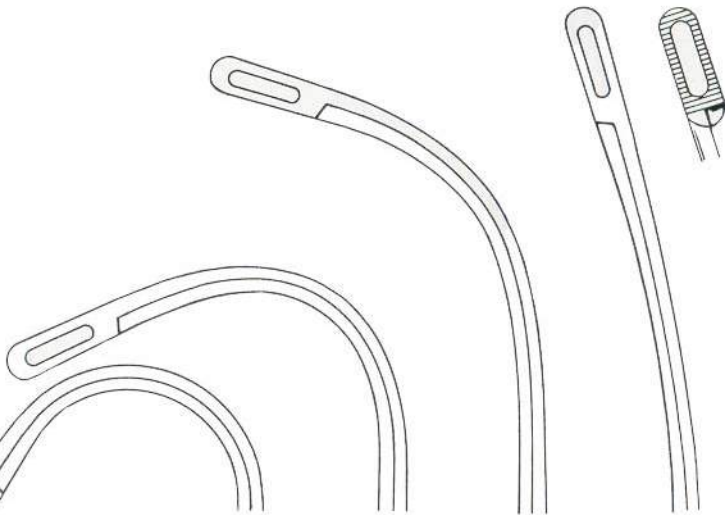

Fig. 4
26-08446-04
22 cm/8¾"

Fig. 3
26-08446-03
22 cm/8¾"

Fig. 2
26-08446-02
22 cm/8¾"

Fig. 1
26-08446-01
23 cm/9"



Gray
26-08450-00

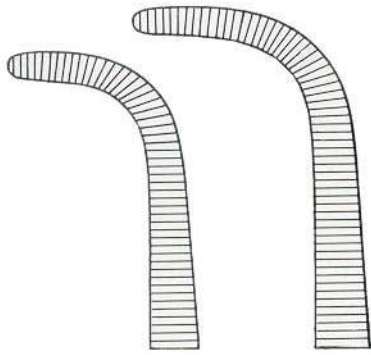

Fig. 1
26-08450-01
22 cm/8¾"

Fig. 2
26-08450-02
23 cm/9"

Set of 2 pieces



Gray
26-08454-00

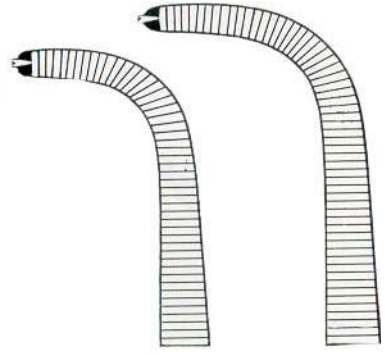

Fig. 1
26-08454-01
22 cm/8¾"

Fig. 2
26-08454-02
23 cm/9"

Set of 2 pieces



Gall duct and
cystic forceps

Desjardins
26-08458-21
21 cm/8¼"



Nissen
26-08462-21
21.5 cm/8½"



Straight **Blake** Curved
26-08466-20 20 cm/8" 26-08467-20



Straight **Mayo-Blake** Curved
26-08472-20 20 cm/8" 26-08473-20



Czerny
26-08476-24
24.5 cm/9¾"



Desjardins
23 cm/9"

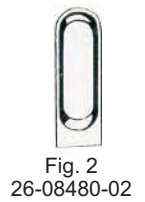



mm	
1	26-08488-01
2	26-08488-02
3	26-08488-03
4	26-08488-04
5	26-08488-05
6	26-08488-06
7	26-08488-07
8	26-08488-08
9	26-08488-09
10	26-08488-10
11	26-08488-11
12	26-08488-12
13	26-08488-13

26-08488-00
set of 9 pieces

26-08488-03 to 26-08488-11

26-08490-00
set of 9 pieces in canvas pocket

Elastic



Desjardins
30 cm/12"



Fig. 1
26-08492-01



Fig. 2
26-08492-02



Fig. 3
26-08492-03



Fig. 4
26-08492-04

Malleable



Luer-Koerte
32 cm/12½"



26-08496-02
2.5 mm



26-08496-03
3.2 mm



26-08496-04
4.2 mm



26-08496-05
5.5 mm



26-08496-06
6.7 mm



26-08496-08
8.0 mm



26-08496-11
11 mm



26-08496-15
15 mm

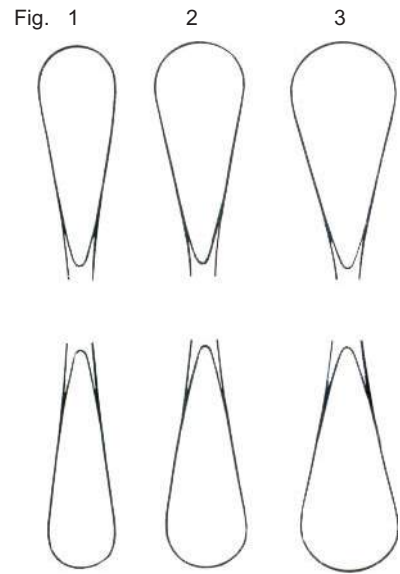

Fig.
1 26-08508-01
2 26-08508-02
3 26-08508-03

Malleable



Mayo
26-08500-28
28 cm/11"



Mayo
26.5 cm/10½"



Fig. 1
26-08504-01



Fig. 2
26-08504-02



Fig. 3
26-08504-03



Moore
26-08506-28
28 cm/11"

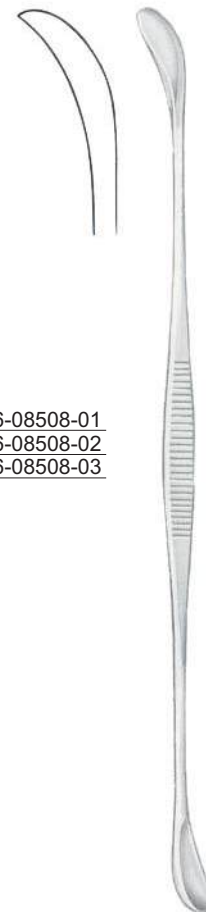

Fergusson
24 cm/9½"



Young
26-08510-21
21 cm/8 1/4"



Young
26-08512-22
22 cm/8 3/4"



Young
26-08514-21
21 cm/8 1/4"



Young
26-08514-22
22 cm/8 3/4"



Millin
26-08516-23
23 cm/9"



Millin
26-08518-23
23 cm/9"



Millin
26-08520-23
23 cm/9"



Millin
26-08522-24
24 cm/9½"

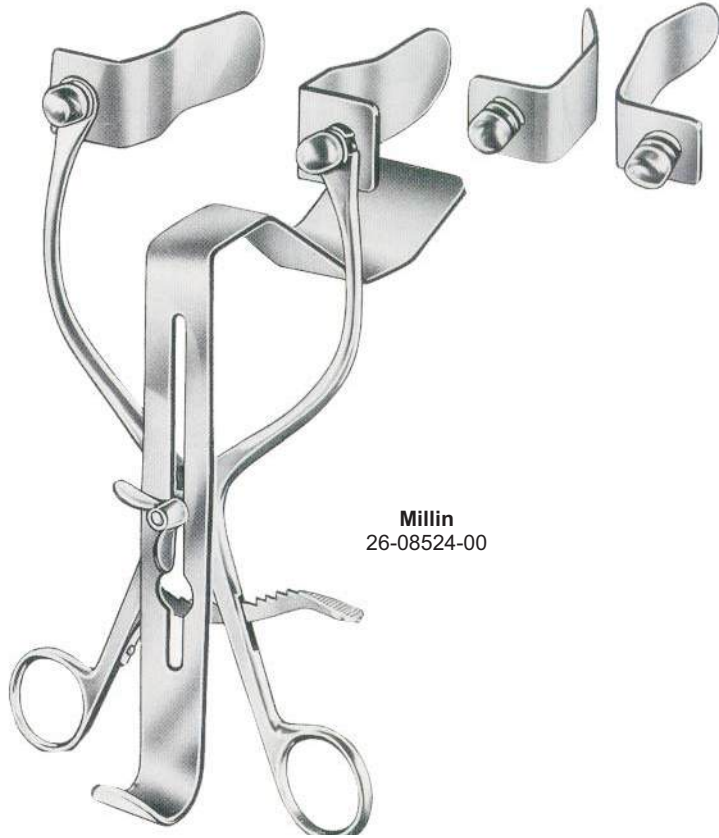

Millin
26-08524-00



Legueu
26-08528-00

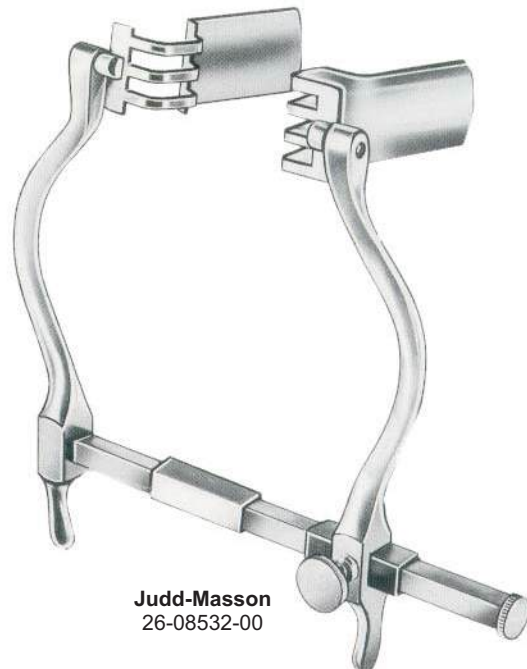

Judd-Masson
26-08532-00



Judd-Masson
26-08536-00



Thomson-Walker
26-08540-00



Legueu
26-08544-27
27 cm/10½"
35 mm



Kocher
26-08548-26
26 cm/10¼"
67 mm

Charriere (French)

mm Ø	Charriere (French)
2 2/3	8
3	9
3 1/3	10
3 2/3	11
4	12
4 1/3	13
4 2/3	14
5	15
5 1/3	16
5 2/3	17
6	18
6 1/3	19
6 2/3	20
7	21
7 1/3	22
7 2/3	23
8	24
8 1/3	25
8 2/3	26
9	27
9 1/3	28
9 2/3	29
10	30
10 1/3	32
11 2/3	34
12	36



Van Buren
Charrier (French)
No. 8-36
26-08552-08
26-08552-36
28 cm/11"
In Canvas Pouch
26-08552-50
Set of 6
6 Pcs. 26-08552-14/24
26-08552-24

26-08552-60
Set of 12
12 Pcs 26-08552-08/30
26-08552-36

26-08552-08
26-08552-10
26-08552-12
26-08552-14
26-08552-16
26-08552-18
26-08552-20
26-08552-22
26-08552-24
26-08552-26
26-08552-28
26-08552-30
26-08552-32
26-08552-34
26-08552-36



Dittel
Charriere (French)
No. 8-30
26-08554-08
26-08554-30
19.5 cm/7 1/2"

Straight

26-08554-08
26-08554-09
26-08554-10
26-08554-11
26-08554-12
26-08554-13
26-08554-14
26-08554-15
26-08554-16
26-08554-17
26-08554-18
26-08554-19
26-08554-20
26-08554-21
26-08554-22
26-08554-23
26-08554-24
26-08554-25
26-08554-26
26-08554-27
26-08554-28
26-08554-29
26-08554-30

Curved

26-08556-08
26-08556-09
26-08556-10
26-08556-11
26-08556-12
26-08556-13
26-08556-14
26-08556-15
26-08556-16
26-08556-17
26-08556-18
26-08556-19
26-08556-20
26-08556-21
26-08556-22
26-08556-23
26-08556-24
26-08556-25
26-08556-26
26-08556-27
26-08556-28
26-08556-29
26-08556-30



Dittel
Charriere (French)
No. 8-30
26-08556-08
26-08556-30
34.5 cm/13 1/2"

For men



26-08560-06
26-08560-24

For Women



	mm Ø	Charriere (French)	
26-08560-06	2	6	26-08562-06
26-08560-07	2 $\frac{1}{3}$	7	26-08562-07
26-08560-08	2 $\frac{2}{3}$	8	26-08562-08
26-08560-09	3	9	26-08562-09
26-08560-10	3 $\frac{1}{3}$	10	26-08562-10
26-08560-11	3 $\frac{2}{3}$	11	26-08562-11
26-08560-12	4	12	26-08562-12
26-08560-13	4 $\frac{1}{3}$	13	26-08562-13
26-08560-14	4 $\frac{2}{3}$	14	26-08562-14
26-08560-15	5	15	26-08562-15
26-08560-16	5 $\frac{1}{3}$	16	26-08562-16
26-08560-17	5 $\frac{2}{3}$	17	26-08562-17
26-08560-18	6	18	26-08562-18
26-08560-19	6 $\frac{1}{3}$	19	26-08562-19
26-08560-20	6 $\frac{2}{3}$	20	26-08562-20
26-08560-21	7	21	26-08562-21
26-08560-22	7 $\frac{1}{3}$	22	26-08562-22
26-08560-23	7 $\frac{2}{3}$	23	26-08562-23
26-08560-24	8	24	26-08562-24

Catheter Introducing Instruments



Guyon
26-08566-39
39 cm/15 $\frac{1}{2}$ "



Guyon
26-08568-35
35 cm/13 $\frac{3}{4}$ "

Circumcision Instruments

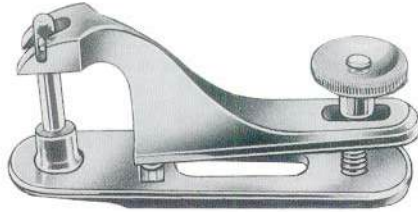

- | | |
|-------------|-------|
| 26-08572-08 | 08 mm |
| 26-08572-11 | 11 mm |
| 26-08572-13 | 13 mm |
| 26-08572-16 | 16 mm |
| 26-08572-21 | 21 mm |
| 26-08572-26 | 26 mm |
| 26-08572-32 | 32 mm |

Foreign Body Forceps

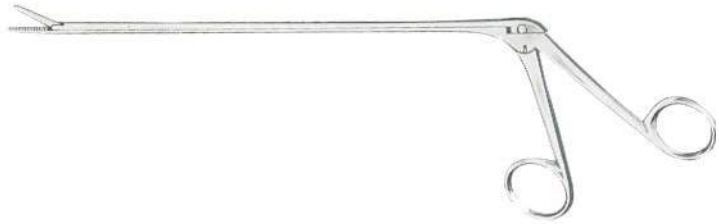

Mathieu
26-08584-20

Penis Clamps

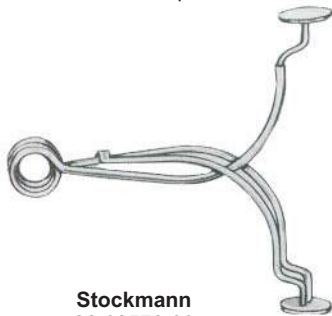

Stockmann
26-08576-00

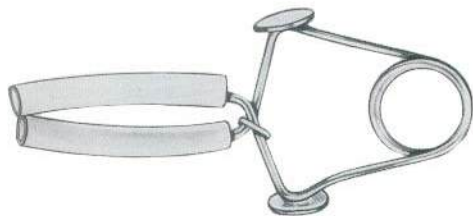

Strauss
26-08580-00

Secretion Scoop



Guttman
26-08588-26
26.5 cm/10½"

Scheme of Dimensions for Specula

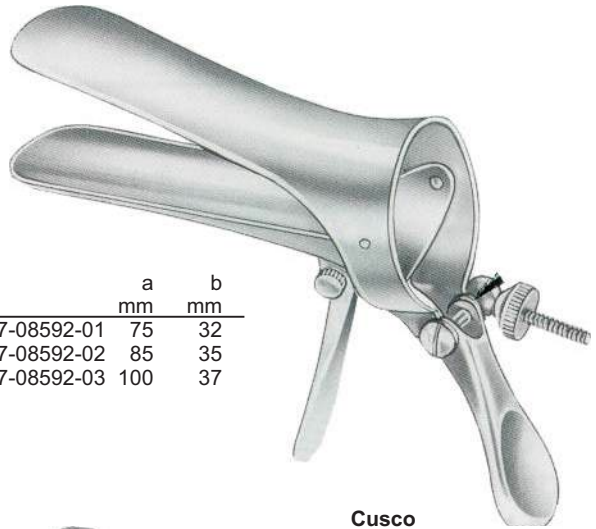
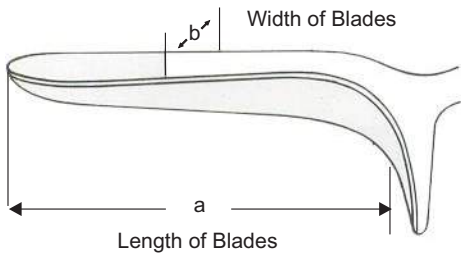

	a mm	b mm
27-08592-01	75	32
27-08592-02	85	35
27-08592-03	100	37

Cusco

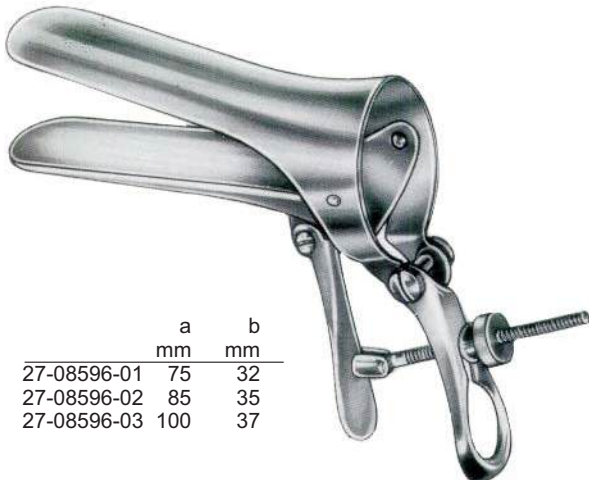

	a mm	b mm
27-08596-01	75	32
27-08596-02	85	35
27-08596-03	100	37

Cusco



For Virgins	a mm	b mm
27-08600-00	75	17

Cusco

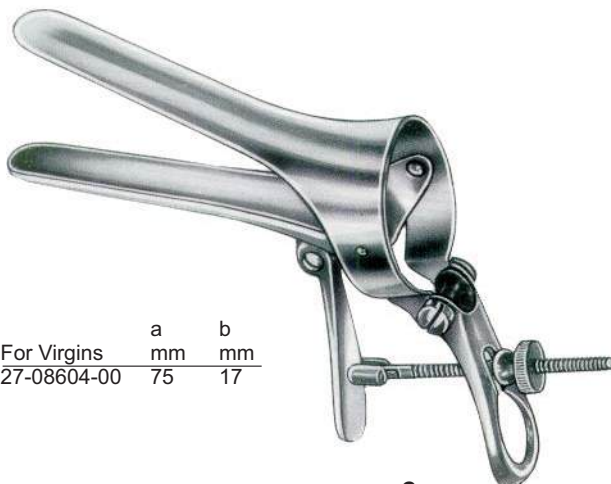

For Virgins	a mm	b mm
27-08604-00	75	17

Cusco



	a mm	b mm
27-08608-01	90	23-25
27-08608-02	100	25-27
27-08608-03	110	27-30

Cusco
Swiss Pattern



Collin-Landau

	a mm	b mm
27-08612-01	85	30
27-08612-02	100	35
27-08612-03	110	40



Collin

	a mm	b mm
27-08616-01	85	30
27-08616-02	100	35
27-08616-03	110	40

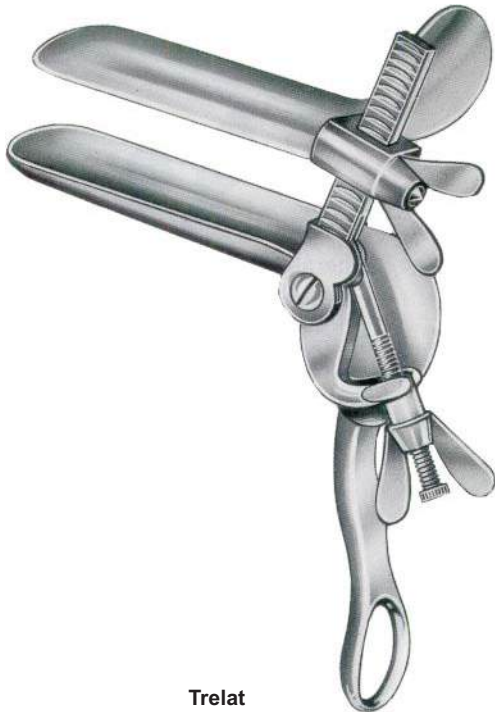

Trelat

	a mm	b mm
27-08620-01	85	33
27-08620-02	95	35
27-08620-03	115	43



Grave (Standard)

	a mm	b mm
27-08624-01	75	20
27-08624-02	95	30
27-08624-03	115	35
27-08624-04	125	35

Insulated

Black



Grave	a mm	b mm
27-08628-01	75	20
27-08628-02	95	30
27-08628-03	115	35



Grave	a mm	b mm
Angled 135° 27-08632-00	101	35



Grave
Right Side open

Grave
Right Side open Angled

	a mm	b mm
27-08636-01	101	35
27-08636-02		

Lateral Specula



27-08640-00



Pederson

	a	b
	mm	mm
27-08644-01	75	13
27-08644-02	100	22
27-08644-03	120	25

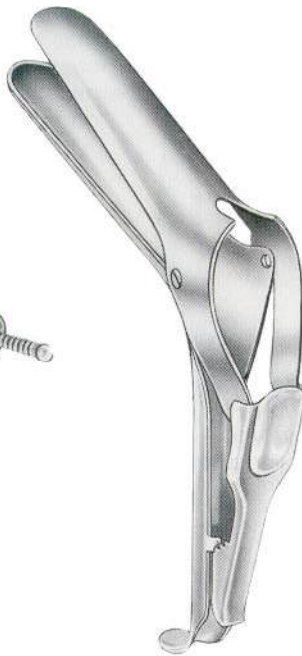

Semm

	a	b
	mm	mm
27-08648-01	90	14/18
27-08648-02	100	17/20
27-08648-03	100	25/30



Nott

	a	b
	mm	mm
27-08652-01	90	30
27-08652-02	110	30

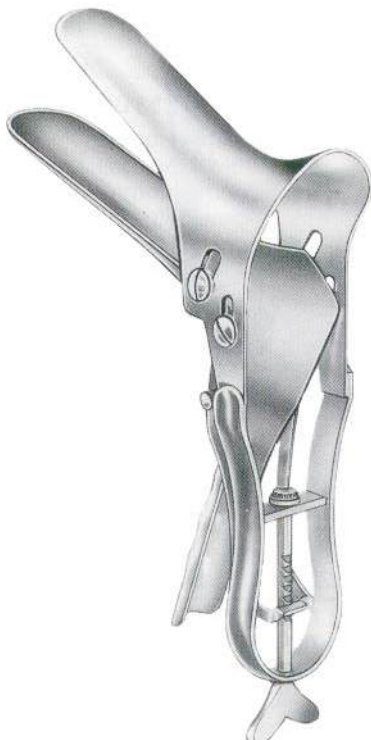

Seyffert

	a	b
	mm	mm
27-08656-01	100	17
27-08656-02	110	33

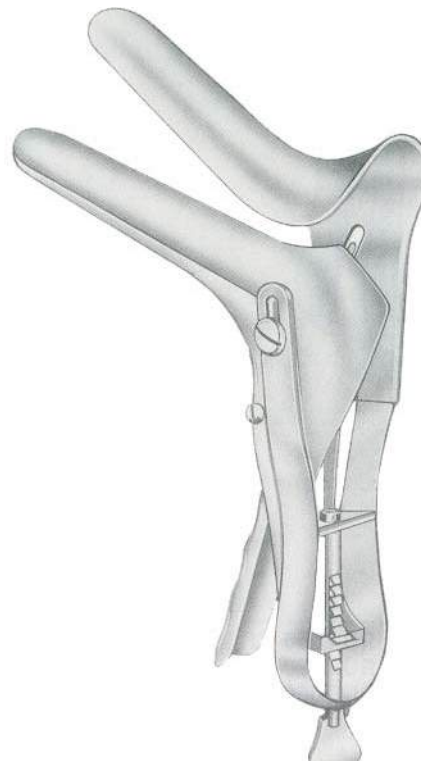

One Side open

Seyffert

	a	b
	mm	mm
27-08658-02	110	33

Scheme of Dimensions for Specula

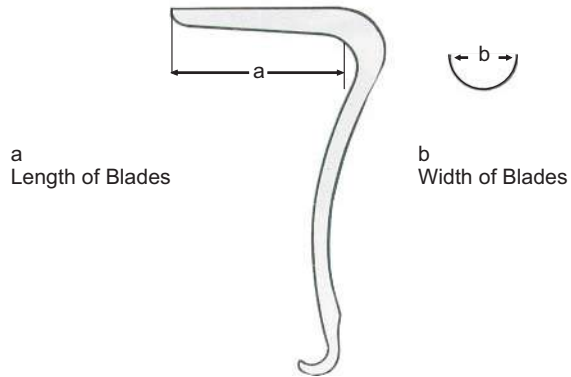

Sims
27-08662-01 63 x 32 mm
27-08662-02 76 x 32 mm
27-08662-03 89 x 38 mm



Sims

	Fig	a mm	b mm
27-08666-01	1	60	25+30
27-08666-02	2	70	30+35
27-08666-03	3	80	35+40



Jackson

	Fig.	a mm	b mm
27-08670-01	1	75 X 40	
27-08670-02	2	90 X 40	
27-08670-03	3	100 X 40	



Eastman

	Fig.	a mm	b mm
27-08674-01	1	76	38
27-08674-02	2	89	38
27-08674-03	3	101	38

For children



Set

Kristeller
27-08678-00
70x15 mm



Specula

Retractor

Kristeller
(Standard)

Set of 1 specula and 1 retractor

Fig. 1 27-08682-00

Fig. 2 27-08684-00

Fig. 3 27-08686-00

Specula

	Fig.	a mm	b mm
27-08682-01	1	70	27
27-07684-01	2	75	30
27-07686-01	3	90	36

Retractors

	Fig.	a mm	b mm
27-08682-02	1	75	23
27-07684-02	2	80	26
27-07686-02	3	95	32



With conically shaped blades for virgins

Kristeller

Set of 1 specula and 1 retractor

Fig. 00 27-08690-00
Fig. 0 27-08692-00

Specula

	Fig.	a	b
		mm	mm
27-08690-01	00	110	18
27-08692-01	0	110	21

Retractors

	Fig.	a	b
		mm	mm
27-08690-02	00	115	14
27-08692-02	0	115	17



With extra long blades

**Kristeller
(Standard)**

Set of 1 specula and 1 retractor

Fig. 1 27-08696-00
Fig. 2 27-08698-00
Fig. 3 27-08700-00

Specula

	Fig.	a	b
		mm	mm
27-08696-01	1	110	27
27-08698-01	2	110	30
27-08700-01	3	110	36

Retractors

	Fig.	a	b
		mm	mm
27-08696-02	1	115	23
27-08698-02	2	115	26
27-08700-02	3	115	32



Set of 1 specula and 1 retractor

Fig. 1 27-08704-00

Fig. 2 27-08706-00

Fig. 3 27-08708-00

Specula

	Fig.	a	b
		mm	mm
27-08704-01	1	110	27
27-08706-01	2	110	30
27-08708-01	3	110	36

Retractors

	Fig.	a	b
		mm	mm
27-08704-02	1	115	23
27-08706-02	2	115	26
27-08708-02	3	115	32

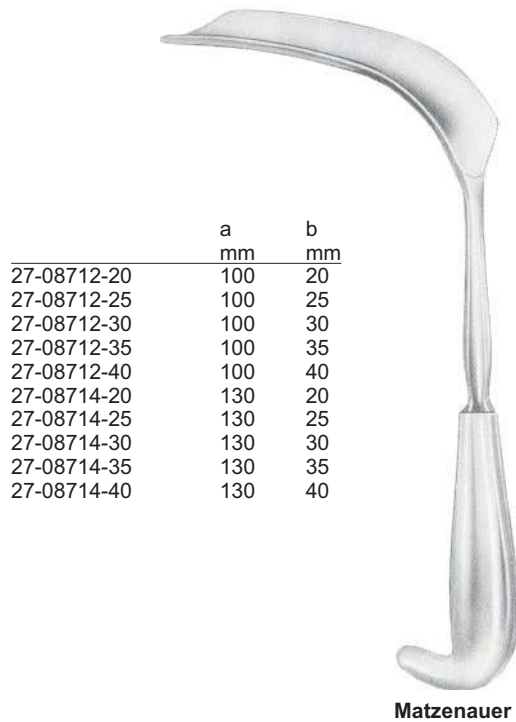

	a	b
	mm	mm
27-08712-20	100	20
27-08712-25	100	25
27-08712-30	100	30
27-08712-35	100	35
27-08712-40	100	40
27-08714-20	130	20
27-08714-25	130	25
27-08714-30	130	30
27-08714-35	130	35
27-08714-40	130	40



27-08718-18
18 cm/7"
56x13 mm



Braun
27-08722-18
18 cm/7"
60x10 mm



Ulrich
27-08726-19
19.5 cm/7½"
80x20 mm



27-08730-19
19 cm/7½"
85x17 mm



Set

27-08734-00 Fig. 1
27-08736-00 Fig. 2

Specula

	Fig.	a		b	
		mm	mm	mm	mm
27-08734-01	1	70	40		
27-08736-01	2	90	40		

Retractors

	Fig.	a		b	
		mm	mm	mm	mm
27-08734-02	1	70	33		
27-08736-02	2	90	33		

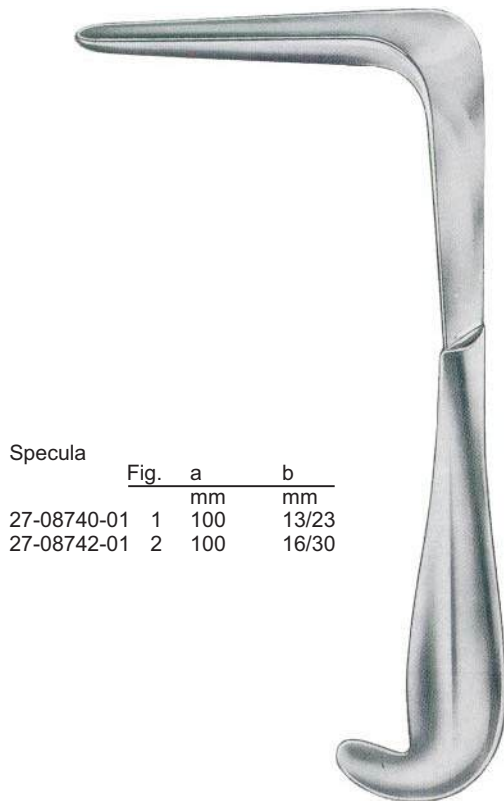

Mathieu

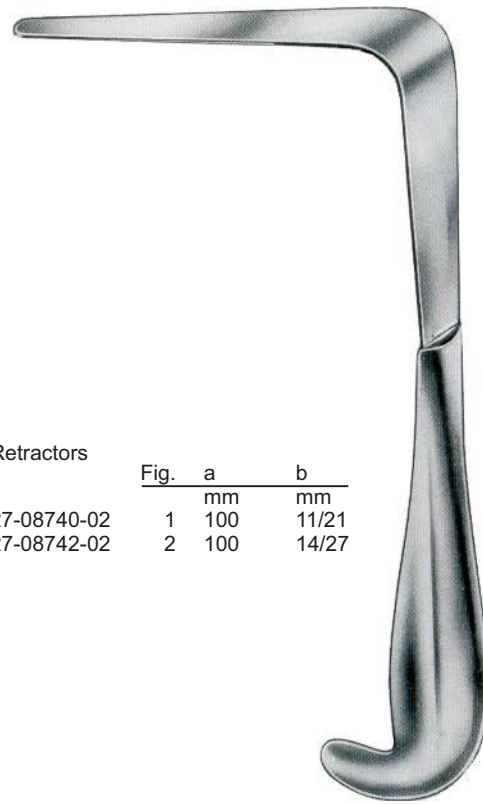

Mathieu

Specula	Fig.	a	b
		mm	mm
27-08740-01	1	100	13/23
27-08742-01	2	100	16/30

Retractors	Fig.	a	b
		mm	mm
27-08740-02	1	100	11/21
27-08742-02	2	100	14/27

Set	Fig.	mm
Fig. 1	27-08740-00	
Fig. 2	27-08742-00	

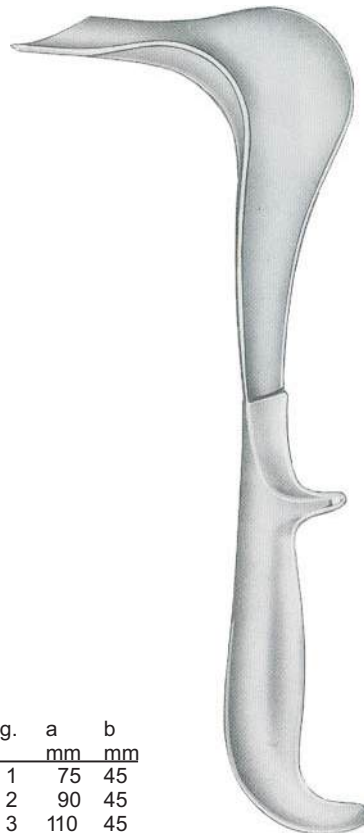

Doyen

	Fig.	a	b
		mm	mm
27-08746-01	1	75	45
27-08746-02	2	90	45
27-08746-03	3	110	45

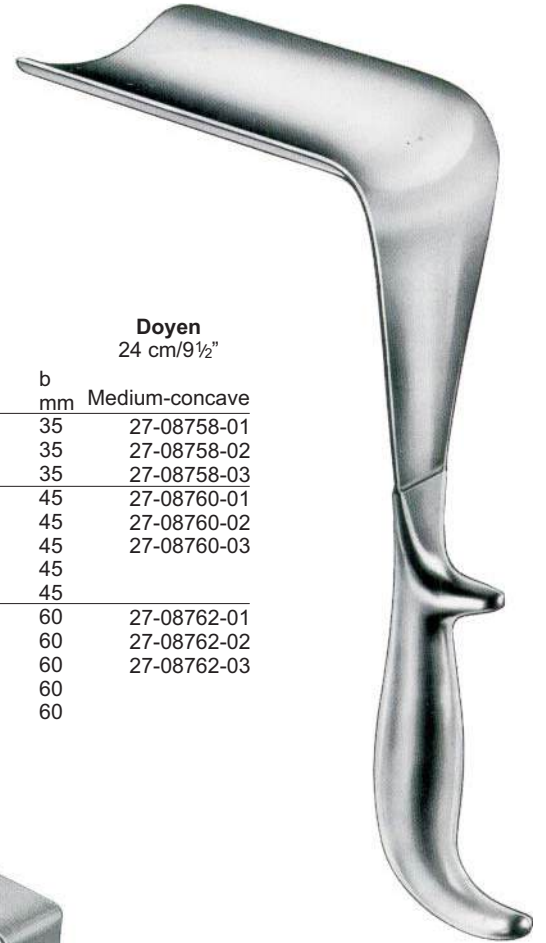

Doyen 24 cm/9½"		Fig.	a mm	b mm	Doyen 24 cm/9½"	
slightly-concave					Medium-concave	
27-08750-01	1		55	35	27-08758-01	
27-08750-02	2		85	35	27-08758-02	
27-08750-03	3		115	35	27-08758-03	
27-08752-01	1		55	45	27-08760-01	
27-08752-02	2		85	45	27-08760-02	
27-08752-03	3		115	45	27-08760-03	
27-08752-04	4		160	45		
27-08752-05	5		180	45		
27-08754-01	1		55	60	27-08762-01	
27-08754-02	2		85	60	27-08762-02	
27-08754-03	3		115	60	27-08762-03	
27-08754-04	4		160	60		
27-08754-05	5		180	60		



Doyen
25 cm/10"

	a mm	b mm
27-08766-01	60	30
27-08766-02	70	30
27-08766-03	80	30



Auvard
with removable weight
27-08770-01
80x38 mm
27-08770-02
105x42 mm



Auvard
with fixed weight
27-08772-01
70x38 mm
27-08772-02
102x45 mm



Landau

	a mm	b mm
27-08776-01	100	28
27-08776-02	100	38



Breisky

	a mm	b mm
27-08780-20	100	20
27-08780-25	100	25
27-08780-30	100	30
27-08780-35	100	35
27-08780-40	100	40
27-08782-20	130	20
27-08782-25	130	25
27-08782-30	130	30
27-08782-35	130	35
27-08782-40	130	40
27-08784-20	160	20
27-08784-25	160	25
27-08784-30	160	30
27-08784-35	160	35
27-08784-40	160	40
27-08786-20	180	20
27-08786-25	180	25
27-08786-30	180	30
27-08786-35	180	35
27-08786-40	180	40



Scherbak
27-08790-00

Complete



27-08790-01
80x30 mm

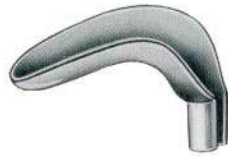

27-08790-02
85x35 mm

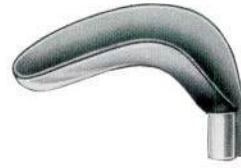

27-08790-03
90x40 mm



27-08790-04
55x40/60 mm



27-08790-05
70x45/70 mm



	Fig.	a mm	b mm
27-08794-01	1	45	17
27-08794-02	2	90	37
27-08794-03	3	90	45



O'Sullivan-O'Connor
27-08794-00
Complete



Hegar

mmØ		mmØ	
1.0	27-08798-01	1.5	27-08800-01
2.0	27-08798-02	2.5	27-08800-02
3.0	27-08798-03	3.5	27-08800-03
4.0	27-08798-04	4.5	27-08800-04
5.0	27-08798-05	5.5	27-08800-05
6.0	27-08798-06	6.5	27-08800-06
7.0	27-08798-07	7.5	27-08800-07
8.0	27-08798-08	8.5	27-08800-08
9.0	27-08798-09	9.5	27-08800-09
10.0	27-08798-10	10.5	27-08800-10
11.0	27-08798-11	11.5	27-08800-11
12.0	27-08798-12	12.5	27-08800-12
13.0	27-08798-13	13.5	27-08800-13
14.0	27-08798-14	14.5	27-08800-14
15.0	27-08798-15	15.5	27-08800-15
16.0	27-08798-16	16.5	27-08800-16
17.0	27-08798-17	17.5	27-08800-17
18.0	27-08798-18	18.5	27-08800-18
19.0	27-08798-19	19.5	27-08800-19
20.0	27-08798-20		
21.0	27-08798-21		
22.0	27-08798-22		
23.0	27-08798-23		
24.0	27-08798-24		
25.0	27-08798-25		
26.0	27-08798-26		
27.0	27-08798-27		
28.0	27-08798-28		
29.0	27-08798-29		
30.0	27-08798-30		

Pieces per set		set
27-08798-50	14	4.0-17.0 mm
27-08798-60	26	1.0-26.0 mm



Hegar

Ø mm	
1.0/2.0	27-08804-02
3.0/4.0	27-08804-04
5.0/6.0	27-08804-06
7.0/8.0	27-08804-08
9.0/10.0	27-08804-10
11.0/12.0	27-08804-12
13.0/14.0	27-08804-14
15.0/16.0	27-08804-16
17.0/18.0	27-08804-18
19.0/20.0	27-08804-20
21.0/22.0	27-08804-22
23.0/24.0	27-08804-24
25.0/26.0	27-08804-26

Pieces per set		set
27-08804-00	08	3.0/4.0-17.0/18.0 mm
27-08806-00	13	1.0/2.0-25.0/26.0 mm



Hank
27-08810-00

Fig.	mm	
9/10	4.5/5	27-08810-10
11/12	5.5/6	27-08810-12
13/14	6.5/7	27-08810-14
15/16	7.5/8	27-08810-16
17/18	8.5/9	27-08810-18
19/20	9.5/10	27-08810-20

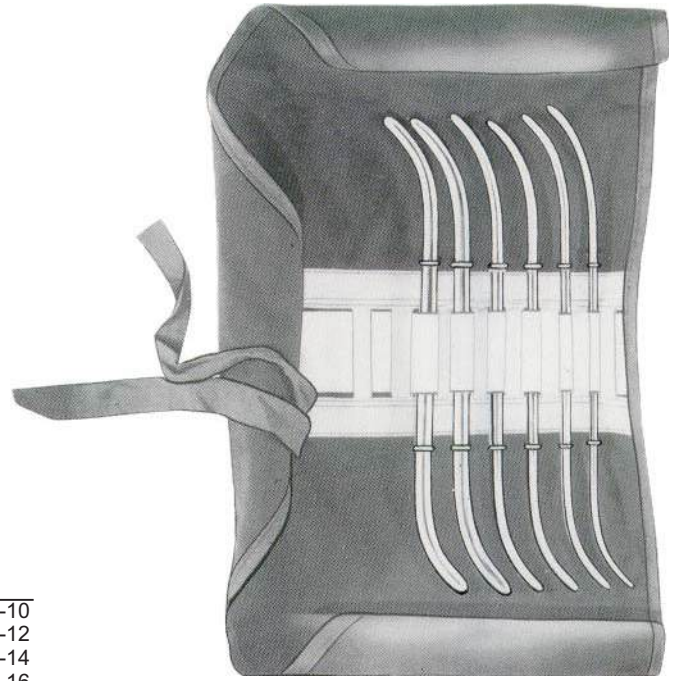

Set
27-08810-00



Pratt

Fig.	mm	
13/15	4.5/5.0	27-08816-15
17/19	5.6/6.3	27-08816-19
21/23	7.0/7.6	27-08816-23
25/27	8.3/9.0	27-08816-27
29/31	9.6/10.3	27-08816-31
33/35	11.0/11.6	27-08816-35
37/39	12.3/13.0	27-08816-39
41/43	13.6/14.3	27-08816-43

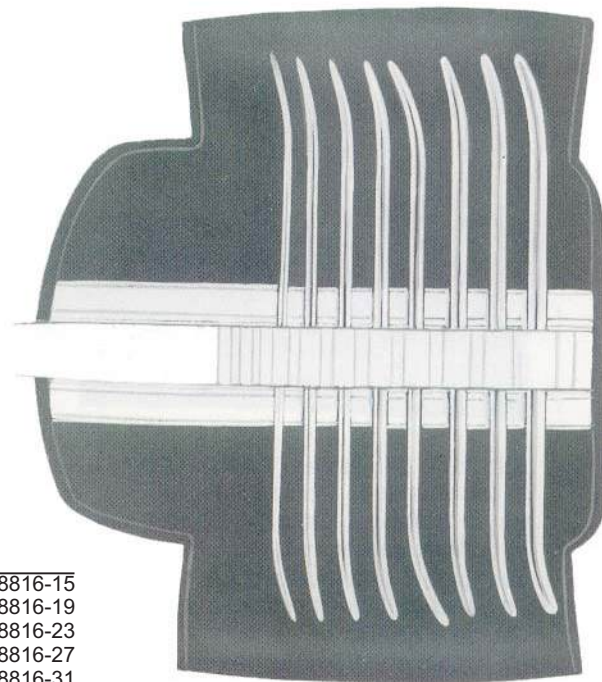

Set
27-08816-00

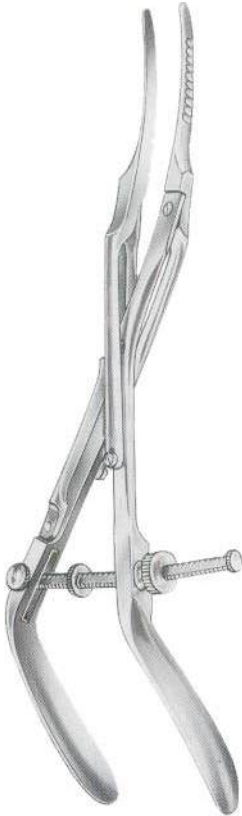

Goodell
27-08820-34
34 cm/13½"

Black Insulated



Kogan-Laser
28 cm/11"



27-08826-28
28 cm/11"



Kogan
27-08830-24
24 cm/9½"

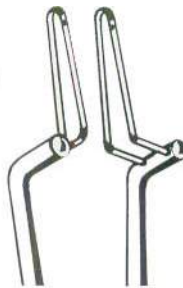

Kogan
27-08832-24
24 cm/9½"

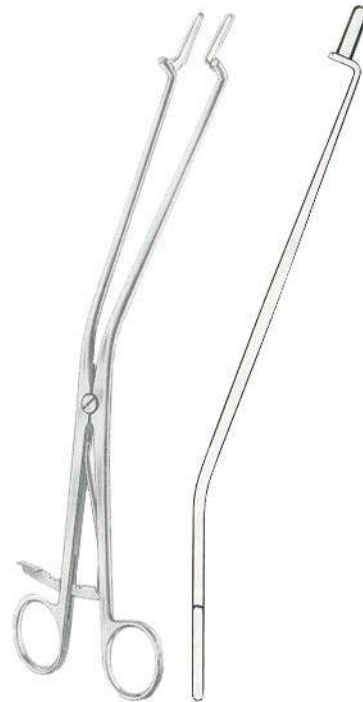

Kogan
28 cm/11"



Uterine Depressor



Sims
32 cm/12½"



Martin (Simpson)
32 cm/12½"



Valleix
27-08858-25
25 cm/10"



Collin
27-08862-28
28 cm/11"



Braun
27-08866-28
28 cm/11"

Rigid	cm	cm
	27-08842-32	27-08850-32

Malleable	cm / in	cm / in
	27-08844-32	27-08852-32
	27-08846-32	27-08854-32

Laser Probes



27-08870-01



90°

27-08870-02



45°

27-08870-03



20°

Measuring Probe



27-08872-01

Laser Probe



27-08874-01



90°

27-08874-02



45°

27-08874-03



20°

Depth Ruler



27-08876-01

Measuring Instruments

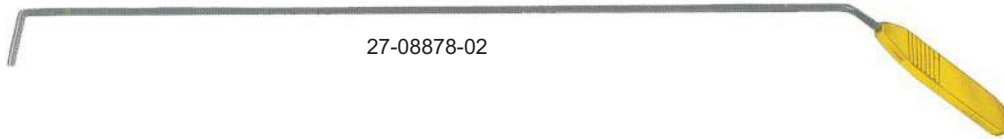
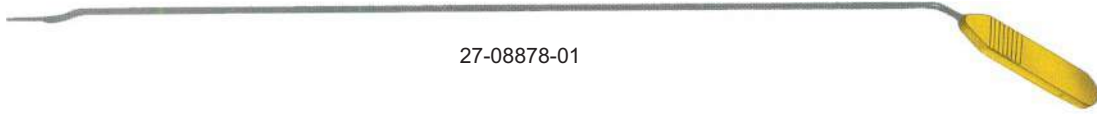

Hooks





Martin
27-08886-27
27 cm/10½"

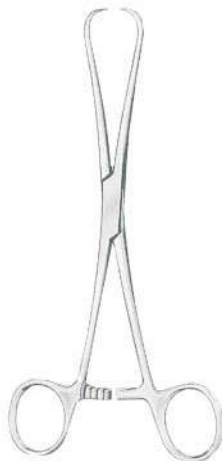

Staude-Moore
27-08890-17
17 cm/6¾"



Barrett
27-08894-18
18 cm/7"



Schroeder
27-08898-25
25 cm/10"



Braun
27-08902-25
25 cm/10"



Collin-Pozzi
27-08906-25
25 cm/10"



Pozzi
27-08910-25
25.5 cm/10¼"

Strong Pattern



Duplay
27-08914-28
28 cm/11"



Skene
27-08918-24
24 cm/9½"



Beacham
27-08922-26
26 cm/10¼"

Amniotome for the amnion Bladder



Czerny
27-08926-20
20.5 cm/8¼"



27-08930-26
26 cm/10¼"



Schroeder
27-08934-20 20 cm/8"
27-08934-24 24 cm/9½"

Straight



Schroeder
27-08936-20
27-08936-24

Curved on Flat



Schroeder
27-08938-20
27-08938-24

Curved Sideway

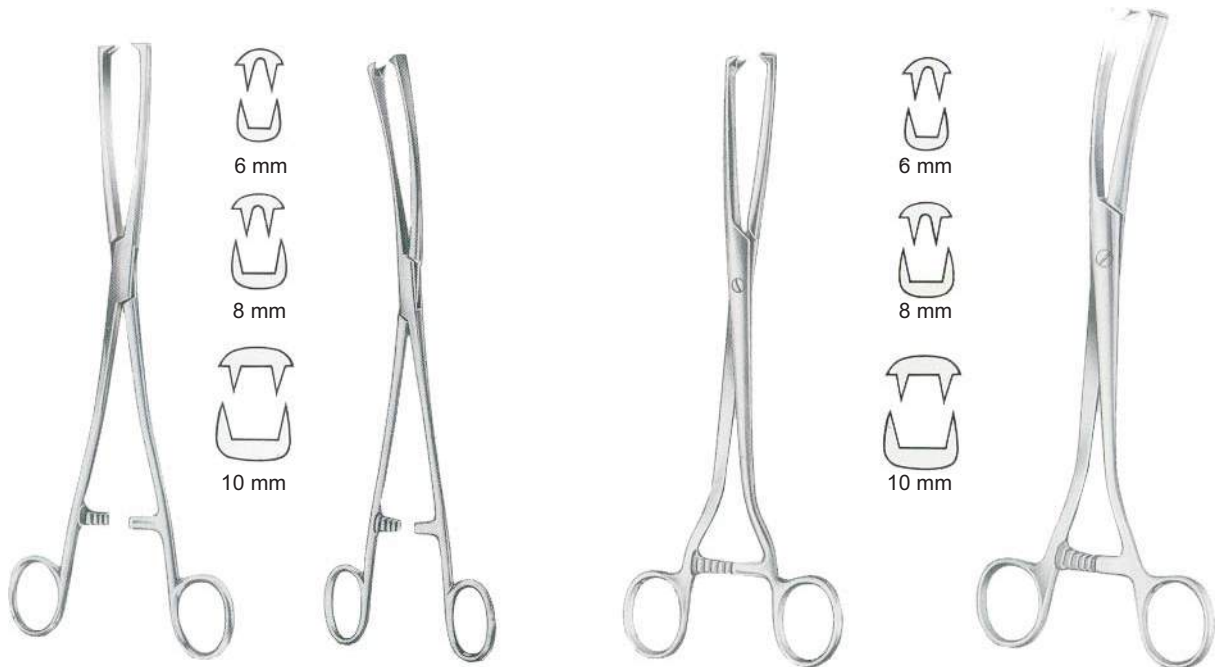

<p>Straight 27-08942-06 27-08942-08 27-08942-10</p>	<p>Museux 24 cm/9½"</p> <p>06 mm 08 mm 10 mm</p>	<p>Curved Sideway 27-08944-06 27-08944-08 27-08944-10</p>
--	---	--

<p>Straight 27-08948-06 27-08948-08 27-08948-10</p>	<p>Museux 24 cm/9½"</p> <p>06 mm 08 mm 10 mm</p>	<p>Curved Sideway 27-08952-06 27-08952-08 27-08952-10</p>
--	---	--



Braun
27-08956-16
16 cm/6¼"



Pratt
27-08960-28
28 cm/11"



Teale
27-08964-24
24 cm/9½"



Iowa
27-08968-26
26 cm/10¼"

For the amnion Bladder



Jacobs
Straight 27-08972-21 21 cm/8¼"
Curved Sideway 27-08974-21



Kelly
27-08978-32
32 cm/12½"



Heywood-Smith
27-08982-20
20 cm/8"

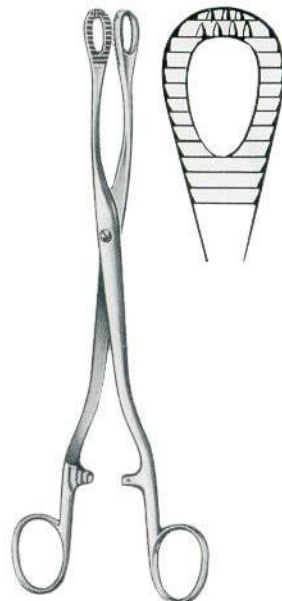

Heywood-Smith
27-08986-25
25 cm/10"



Noto
27-08990-27
27 cm/10½"



Dartigues
27-08994-27
27 cm/10½"



Somer
27-08998-23
23 cm/9"



Collin
27-09002-25
25 cm/10"



Doyen
27-09006-18 18 cm/7"
27-09006-20 20 cm/8"

Ovarian Forceps



Ayre
27-09010-23
23 cm/9"



Simon
27-09014-22
22 cm/8¾"



Simon
27-09016-22
22 cm/8¾"



Emmet
22 cm/8¾"



Doyen
27-09024-17
17 cm/6¾"



Doyen
27-09026-17
17 cm/6¾"



Segond
27-09030-27
27 cm/10½"

Secretion Spoon



4 mmØ

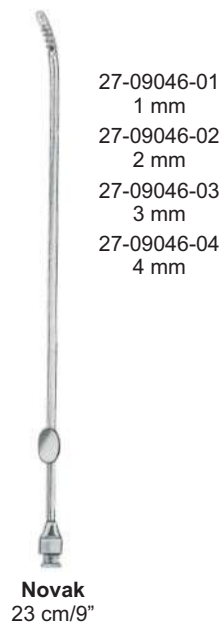



Kevorkian
27-09054-30
30 cm/12"

malleable
27-09056-30
30 cm/12"



Kevorkian
27-09060-30
30 cm/12"

malleable
27-09062-30
30 cm/12"



Townsend
27-09066-30
31 cm/12¼"

malleable
27-09068-30
31 cm/12¼"



Duncan
27-09072-31
31 cm/12¼"



Duncan
27-09074-31
31 cm/12¼"



Gellhorn
27-09078-23
23 cm/9"



Thoms-Gaylor
27-09082-24
24 cm/9½"



Schubert
27-09086-21 21 cm/8¼"
27-09086-29 29 cm/11¼"



Schubert
27-09090-26
26 cm/10¼"



Tischler
27-09094-27
27 cm/10½"



Van Doren
27-09098-25
25 cm/10"

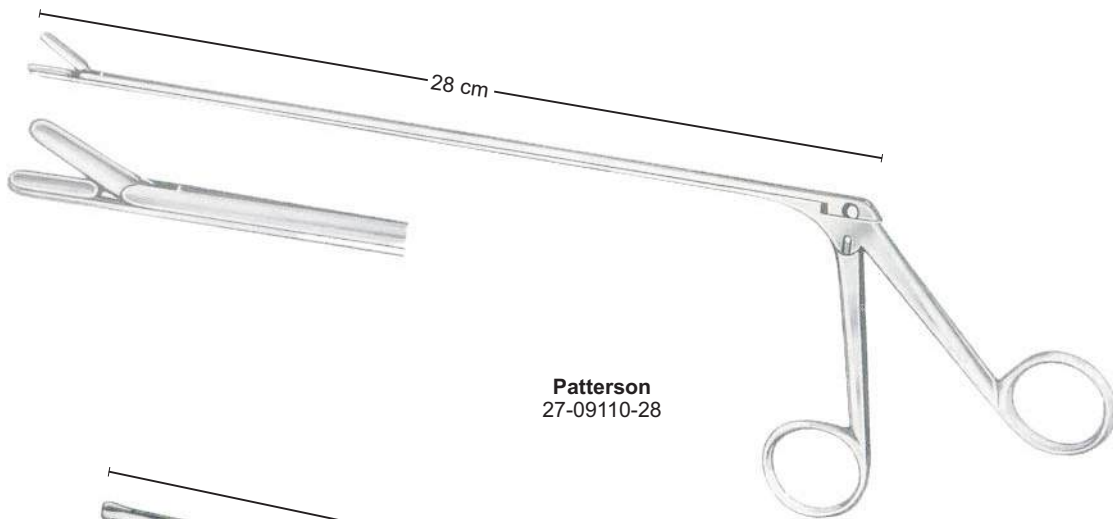

Fig.1
Fig.2

Schumacher
Fig. 1 27-09102-01 24 cm/9½"
Fig. 2 27-09102-02 24 cm/9½"



Faure
27-09106-21
21 cm/8¼"



Patterson
27-09110-28

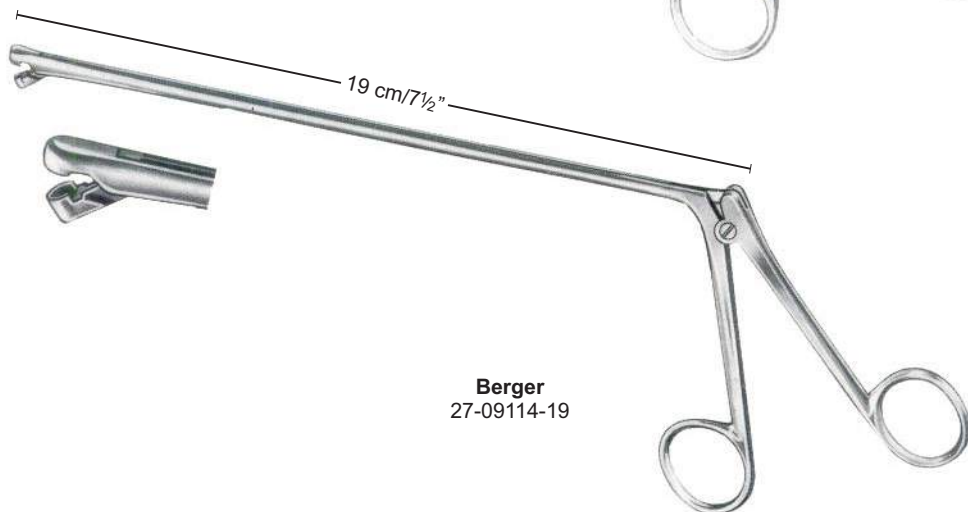

Berger
27-09114-19



- 27-09118-20 L = 20 cm/8"
- 27-09118-25 L = 25 cm/10"
- 27-09118-30 L = 30 cm/12"
- 27-09118-35 L = 35 cm/14"
- 27-09118-40 L = 40 cm/16"

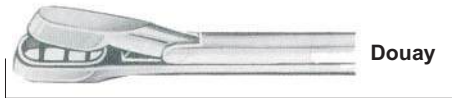

L = 24 cm/9½"



27-09124-04
4 mm

27-09124-06
6 mm

L = 24 cm/9½"



27-09128-24

L = 20 cm/8"



Eppendorf

27-09122-20

L = 23 cm/9"



Wittner

27-09126-23

L = 23 cm/9"



Wittner

27-09130-23

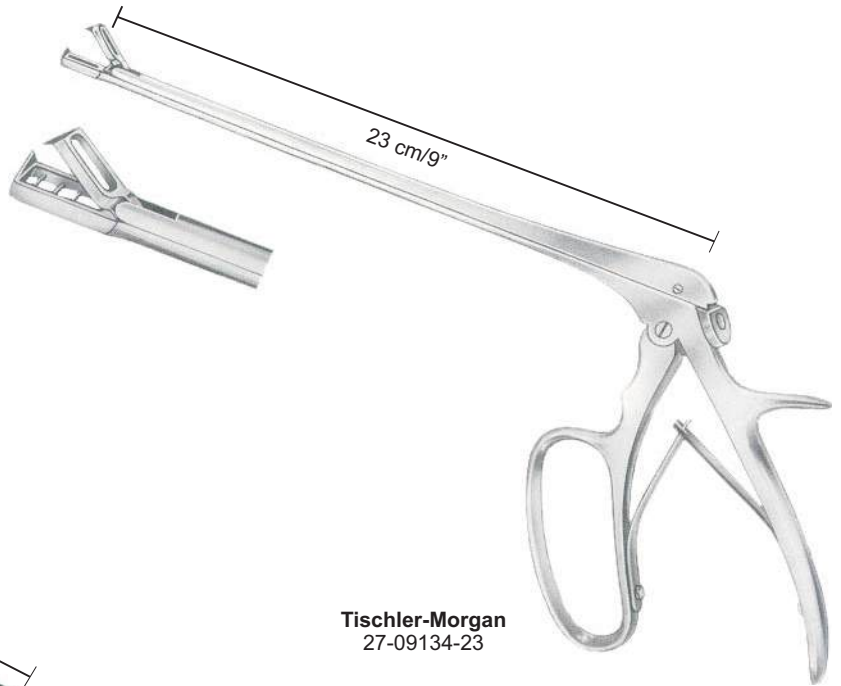

Tischler-Morgan
27-09134-23



Baby-Tischler
27-09136-21



Alexander
27-09140-28

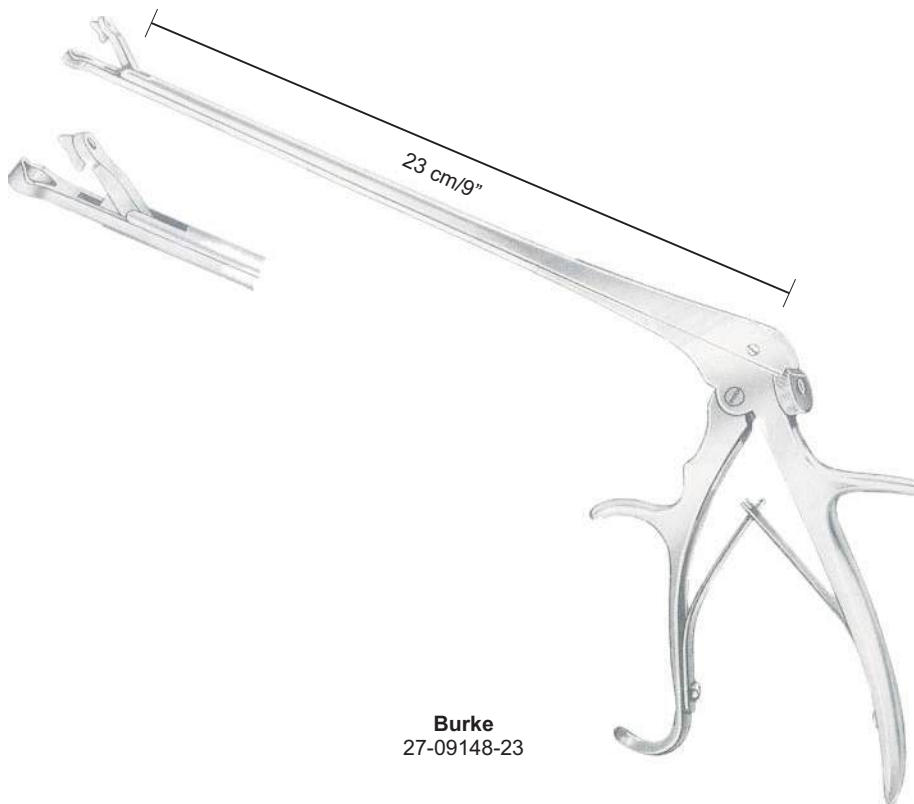
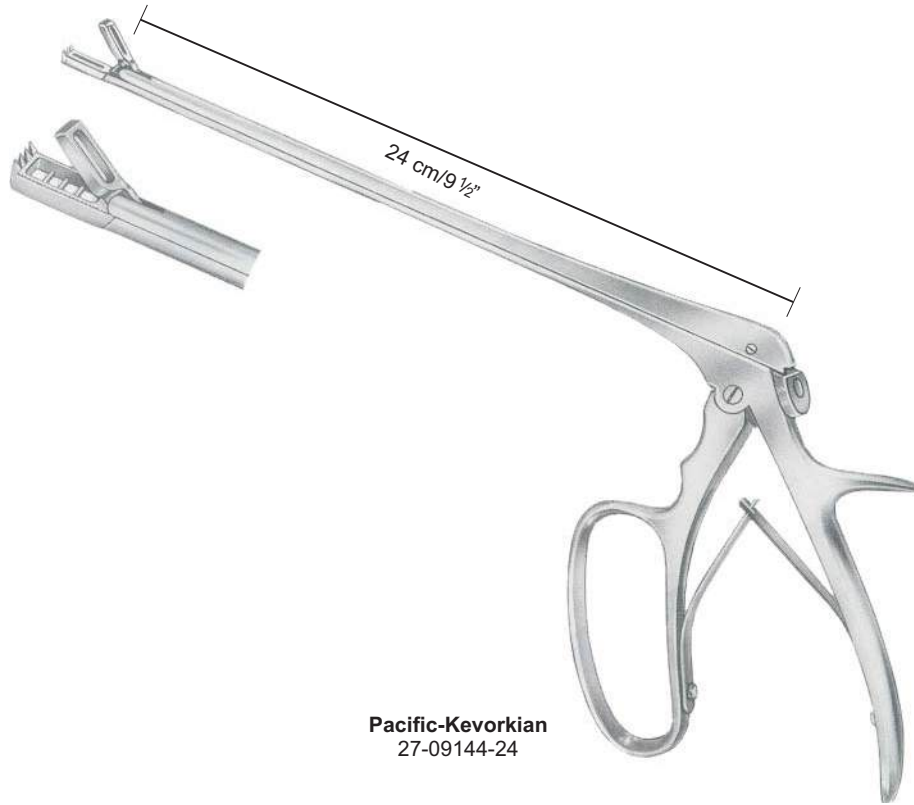



Handle



Tip with tube

Townsend

Complete instrument

Tip, only



Tischier

27-09152-00

27-09152-01



Kevorkian

27-09154-00

27-09154-01



Mini-Townsend

27-09156-00

27-09156-01

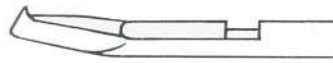

Tischler-up

27-09158-00

27-09158-01

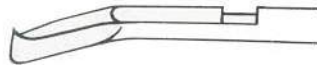

Tischler-down

27-09160-00

27-09160-01

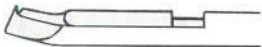

Mini-Townsend-up

27-09162-00

27-09162-01

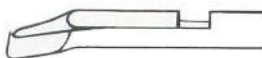

Mini-Townsend-down

27-09164-00

27-09164-01



Schroeder
30 cm/12"

Sharp Rigid



Fig. 1
27-09168-01
27-09170-01



Fig. 2
27-09168-02
27-09170-02



Fig. 3
27-09168-03
27-09170-03

Schroeder
Simon



Fig. 4
27-09168-04
27-09170-04



Fig. 5
27-09168-05
27-09170-05



Fig. 6
27-09168-06
27-09170-06

Schroeder
Simon



Simon
25 cm/10"



Gourdet
28 cm/11"



Fig. 1
27-09174-01
6 mm



Fig. 2
27-09174-02
8 mm



Fig. 3
27-09174-03
10 mm



Fig. 4
27-09174-04
12 mm



Fig. 5
27-09174-05
14 mm



Thomas



Fig. 1
27-09177-01



Fig. 2
27-09177-02



Fig. 3
27-09177-03



Fig. 4
27-09177-04



Fig. 5
27-09177-05



Fig. 6
27-09177-06



Greene

27-09180-10
10 mm

27-09180-12
12 mm

27-09180-14
14 mm



Collin
27-09184-30
30 cm/12"



Heaney
27-09188-24
24 cm/9½"



Heaney
27-09192-24
24 cm/9½"



Milan
28.5 cm/11¼"

Malleable

27-09196-05
5 mm Ø

27-09196-07
7 mm Ø

27-09196-09
9 mm Ø

Rigid

27-09198-05
5 mm Ø

27-09198-07
7 mm Ø

27-09198-09
9 mm Ø



28 cm/11"

Hose Connecting Piece



27-09206-00

- | | Ø |
|-------------|---------|
| 27-09202-04 | 4.0 mm |
| 27-09202-06 | 6.0 mm |
| 27-09202-08 | 8.0 mm |
| 27-09202-10 | 10.0 mm |
| 27-09202-12 | 12.0 mm |
| 27-09202-14 | 14.0 mm |
| 27-09202-16 | 16.0 mm |



Sims
25 cm/10"

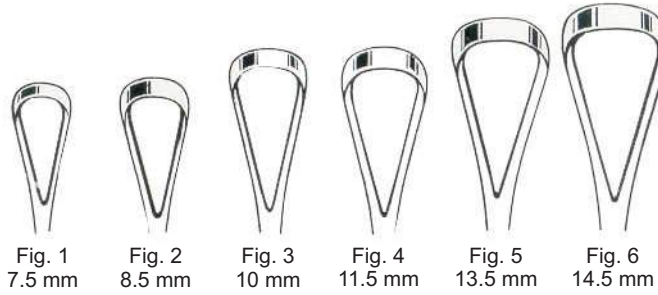

Malleable		Rigid	
Sharp	Blunt	Sharp	Blunt

Fig. 1	27-09210-01	27-09211-01	27-09214-01	27-09215-01
Fig. 2	27-09210-02	27-09211-02	27-09214-02	27-09215-02
Fig. 3	27-09210-03	27-09211-03	27-09214-03	27-09215-03
Fig. 4	27-09210-04	27-09211-04	27-09214-04	27-09215-04
Fig. 5	27-09210-05	27-09211-05	27-09214-05	27-09215-05
Fig. 6	27-09210-06	27-09211-06	27-09214-06	27-09215-06



Sims
25 cm/10"

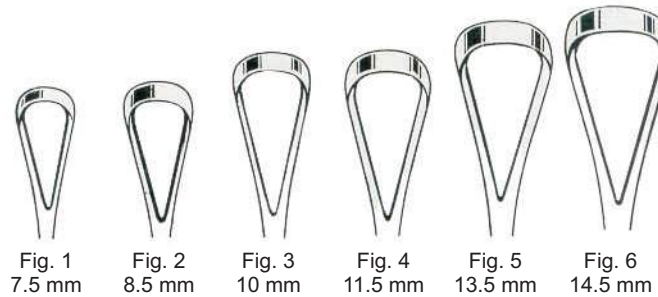

Malleable		Rigid	
Sharp	Blunt	Sharp	Blunt

Fig. 1	27-09218-01	27-09219-01	27-09222-01	27-09223-01
Fig. 2	27-09218-02	27-09219-02	27-09222-02	27-09223-02
Fig. 3	27-09218-03	27-09219-03	27-09222-03	27-09223-03
Fig. 4	27-09218-04	27-09219-04	27-09222-04	27-09223-04
Fig. 5	27-09218-05	27-09219-05	27-09222-05	27-09223-05
Fig. 6	27-09218-06	27-09219-06	27-09222-06	27-09223-06

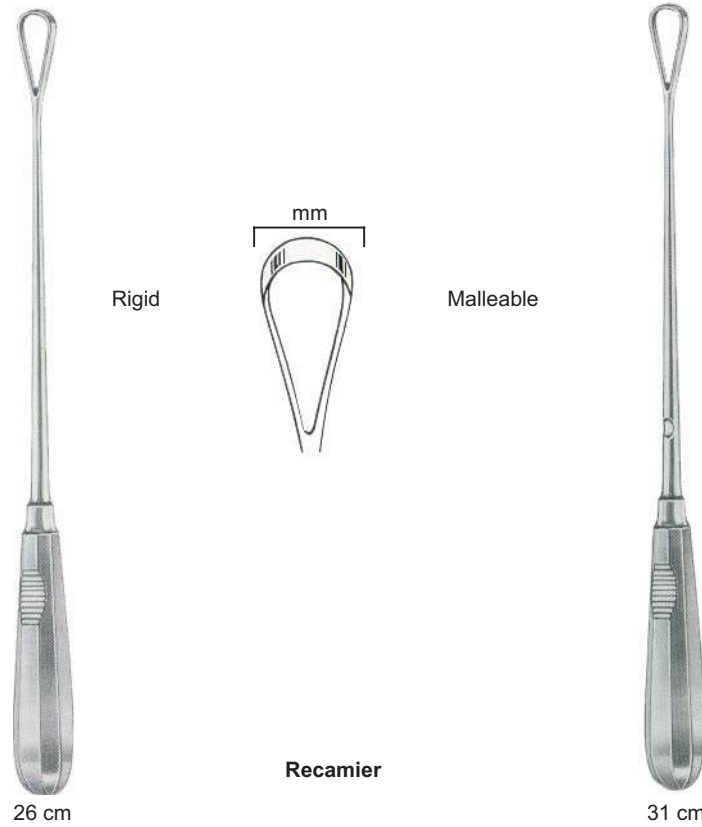

Fig.	mm	Malleable		Rigid		Malleable		Rigid	
		Sharp	Blunt	Sharp	Blunt	Sharp	Blunt	Sharp	Blunt
00	5	27-09226-05	27-09227-05	27-09228-05	27-09229-05	27-09230-05	27-09231-05	27-09232-05	27-09233-05
0	6	27-09226-06	27-09227-06	27-09228-06	27-09229-06	27-09230-06	27-09231-06	27-09232-06	27-09233-06
1	7	27-09226-07	27-09227-07	27-09228-07	27-09229-07	27-09230-07	27-09231-07	27-09232-07	27-09233-07
2	8	27-09226-08	27-09227-08	27-09228-08	27-09229-08	27-09230-08	27-09231-08	27-09232-08	27-09233-08
3	9	27-09226-09	27-09227-09	27-09228-09	27-09229-09	27-09230-09	27-09231-09	27-09232-09	27-09233-09
4	10	27-09226-11	27-09227-11	27-09228-11	27-09229-11	27-09230-11	27-09231-11	27-09232-11	27-09233-11
5	12	27-09226-12	27-09227-12	27-09228-12	27-09229-12	27-09230-12	27-09231-12	27-09232-12	27-09233-12
6	14	27-09226-14	27-09227-14	27-09228-14	27-09229-14	27-09230-14	27-09231-14	27-09232-14	27-09233-14
7	15	27-09226-15	27-09227-15	27-09228-15	27-09229-15	27-09230-15	27-09231-15	27-09232-15	27-09233-15
8	16	27-09226-16	27-09227-16	27-09228-16	27-09229-16	27-09230-16	27-09231-16	27-09232-16	27-09233-16
9	19	27-09226-19	27-09227-19	27-09228-19	27-09229-19	27-09230-19	27-09231-19	27-09232-19	27-09233-19
10	20	27-09226-20	27-09227-20	27-09228-20	27-09229-20	27-09230-20	27-09231-20	27-09232-20	27-09233-20
11	21	27-09226-21	27-09227-21	27-09228-21	27-09229-21	27-09230-21	27-09231-21	27-09232-21	27-09233-21
12	23	27-09226-23	27-09227-23	27-09228-23	27-09229-23	27-09230-23	27-09231-23	27-09232-23	27-09233-23
13	25					27-09230-25	27-09231-25	27-09232-25	27-09233-25
14	30					27-09230-30	27-09231-30	27-09232-30	27-09233-30
15	35					27-09230-35	27-09231-35	27-09232-35	27-09233-35
16	40					27-09230-40	27-09231-40	27-09232-40	27-09233-40



Bumm
max. 29 cm/11½"

Fig.	mm	Mealleable	
		Sharp	Blunt
0	16.0	27-09236-16	27-09237-16
1	18.0	27-09236-18	27-09237-18
2	19.5	27-09236-19	27-09237-19
3	21.5	27-09236-21	27-09237-21
4	23.5	27-09236-23	27-09237-23
5	26.0	27-09236-26	27-09237-26
6	28.5	27-09236-28	27-09237-28



Blunt

Sharp

Blake (Zweifel)
27-09240-27 27 cm/10½"
27-09240-31 31 cm/12¼"

For Internal Measurements



28-09244-45
Laparotomy Ring
1¾" Inside Diameter



De Lee
28-09248-20
20 cm/8"
cm/Inch Scale



Martin
28-09252-34 34 cm/13½"
cm Scale 28-09254-34
cm/Inch Scale



Collin
28-09258-35
35 cm/13¾"
cm Scale



Breisky
28-09262-33
33 cm/13"
cm Inch Scale





Collyer
28-09266-30
30 cm/12"
cm Inch Scale



Iowa
28-09270-14
14 cm/5½"
Trumpet Needle Guide



Winter
28 cm/11"

			
Straight	28-09274-01	28-09274-02	28-09274-03
Curved	28-09275-01	28-09275-02	28-09275-03



Wallich
28-09278-42
42 cm/16¾"

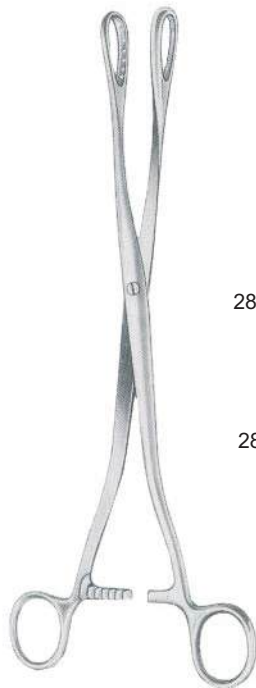

Sanger
27 cm/10½"

Straight	28-09282-27
Curved	28-09283-27

Uterine Haemostasis Forceps



Green-Armytage
28-09286-21
21 cm/8¼"

Scalp Flap Forceps



Gauss
28-09290-26
26 cm/10¼"



Willet-Martel
28-09294-19
19 cm/7½"

Head Lever



Murless
28-09298-26
26 cm/10¼"

Elevating Spoon



Sellheim
28-09302-28
28 cm/11"



Smellie
28-09306-25
25 cm/10"

Perforators



Nagele
28-09310-25
25 cm/10"

Cranioclast



Braun
28-09314-42
42 cm/16½"

Basiotribe



Tarnier
28-09318-46
46 cm/18"

Decapitating Hook



Braun
28-09322-30
30 cm/12"

Umbilical Cord Clamps



Collin
28-09326-09
9 cm/3½"



Nagele
28-09330-36 36 cm/14"
28-09330-40 40 cm/16"



Wrigley
28-09334-28
28 cm/11"



Simpson
28-09338-23
23 cm/9"



Simpson
28-09340-30
30 cm/12"



Simpson-Braun
28-09342-36
36 cm/14"



Simpson-Luikart
28-09344-36
36 cm/14"



De Lee
28-09348-30 30 cm/12"
28-09348-36 36 cm/14"

Traction Handles to be used with all obstetrical Forceps with Standard type Handles



Bill
28-09350-20

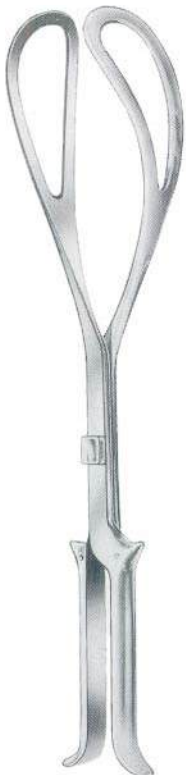

Kielland
28-09352-41
41 cm/16"



Kielland-Luikart
28-09354-40
40 cm/15¾"



McLean
28-09358-36
36 cm/14"



Elliot
28-09362-32 32 cm/12½"
28-09362-38 38 cm/15"



Piper
28-09366-44
44 cm/17¼"



With Traction Handle

Barnes-Neville
28-09370-43
43.5 cm/17"



With Traction Handle

Tarnier
28-09374-40
40 cm/15¾"



Sauerbruch
29-09378-24 24 cm/9½"
29-09378-26 26 cm/10¼"



Giertz-Stille
29-09382-27
27 cm/10½"

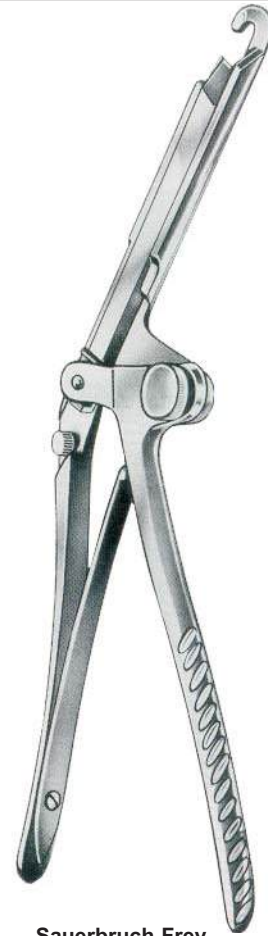

Sauerbruch-Frey
29-09386-36
36 cm/14"



Bethune
29-09390-34
34 cm/13½"

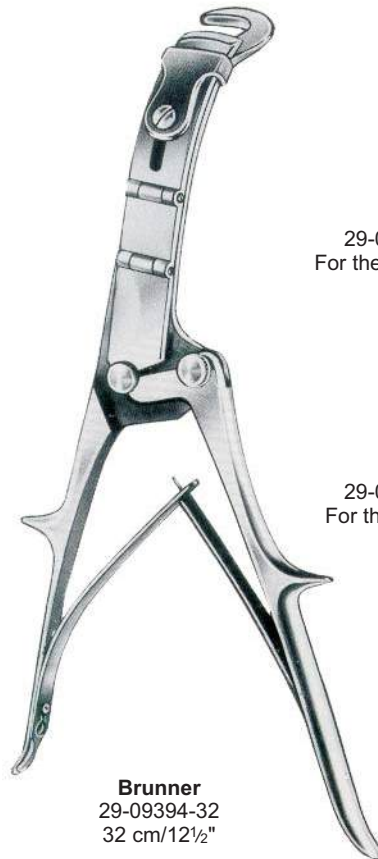

Brunner
29-09394-32
32 cm/12½"

29-09394-32
For the Right Hand

29-09395-32
For the left Hand



Lebsche
29-09398-24
24.5 cm/9¾"

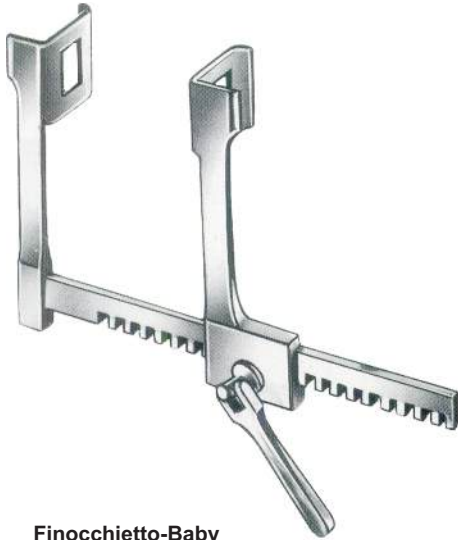

Finocchietto-Baby

	a	b	c
29-09402-00	18 mm	21 mm	105 mm

Scheme of Dimensions

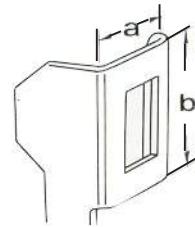

Size of Blades

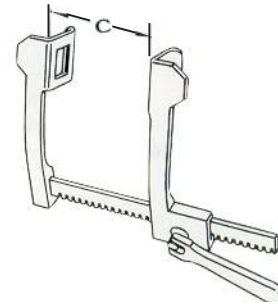

Total Spread



Finocchietto

	a	b	c
29-09406-01	36 mm	45 mm	165 mm
29-09406-02	44 mm	65 mm	200 mm
29-09406-03	44 mm	65 mm	250 mm
29-09406-04	44 mm	65 mm	300 mm
29-09406-05	65 mm	65 mm	200 mm
29-09406-06	65 mm	65 mm	250 mm
29-09406-07	65 mm	65 mm	300 mm

With 2 Pairs of Interchangeable Blades

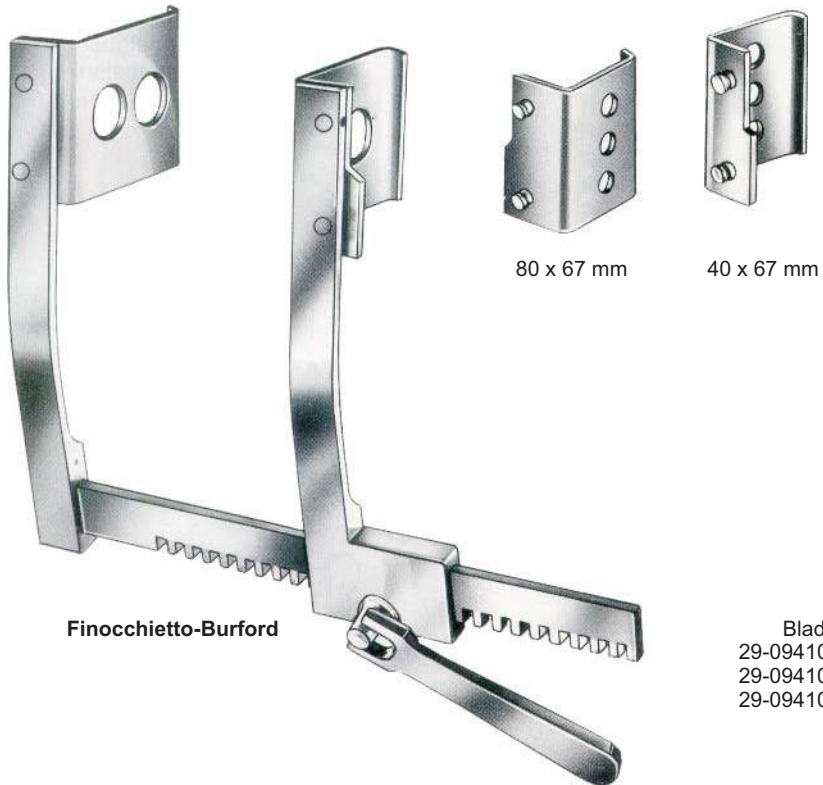

Blade Opening
 29-09410-01 200 mm/8"
 29-09410-02 250 mm/10"
 29-09410-03 305 mm/12"



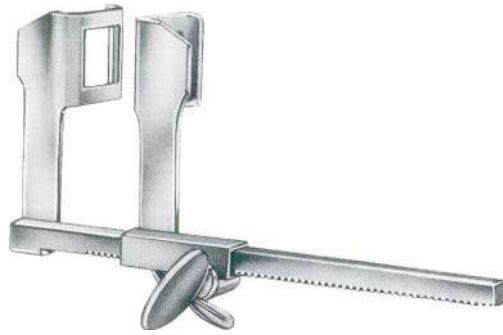

Haight

	a	b	c
29-09418-00	30 mm	30 mm	115 mm

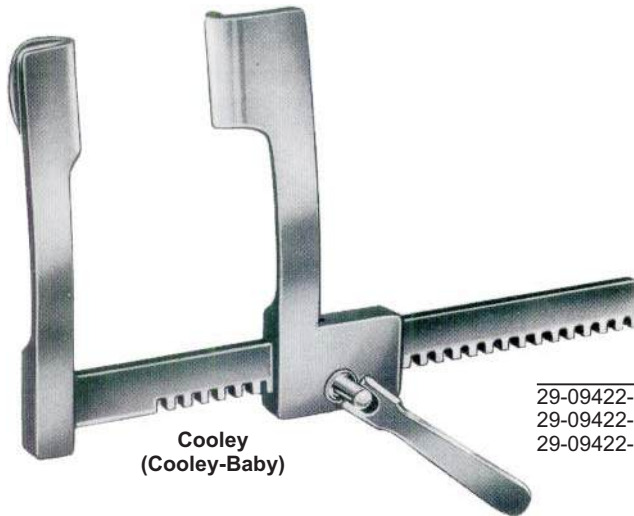

**Cooley
(Cooley-Baby)**

	a	b	c
29-09422-01	15 mm	30 mm	75 mm
29-09422-02	21 mm	45 mm	145 mm
29-09422-03	32 mm	50 mm	190 mm



De Bakey
29-09426-00
With 3 Pairs of Blades
29-09426-01
29-09426-02
29-09426-03

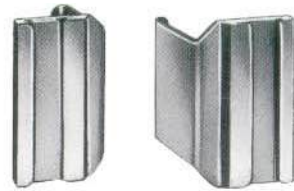

29-09426-01
60 x 60 mm



29-09426-02
50 x 80 mm

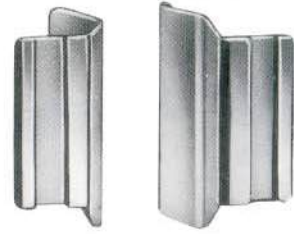

29-09426-03
40 x 100 mm



29-09426-04
80 x 60 mm



29-09426-05
50 x 66 mm

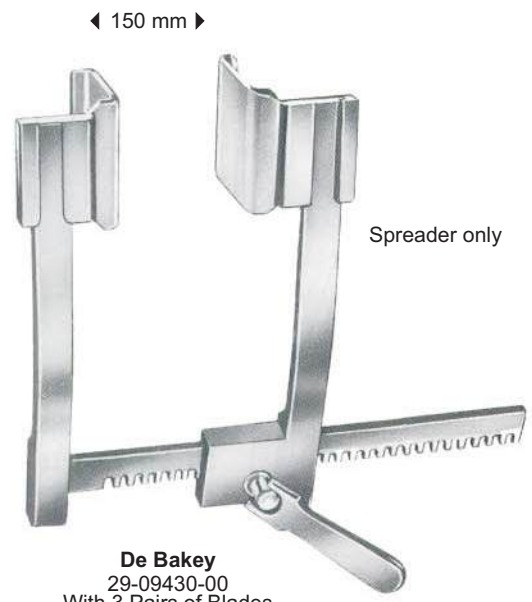

De Bakey
29-09430-00
With 3 Pairs of Blades



29-09430-01
30 x 30 mm



29-09430-02
40 x 40 mm



29-09430-03
50 x 50 mm

◀ Fig. 1 15 cm/6" ▶
◀ Fig. 2 20 cm/8" ▶



Morse-Favaloro
Fig. 1 29-09434-01
Fig. 2 29-09434-02

75 x 75 mm

42 x 65 mm

Thoracic Retractor



(Mercedes-Retractor)
29-09436-00
Complete

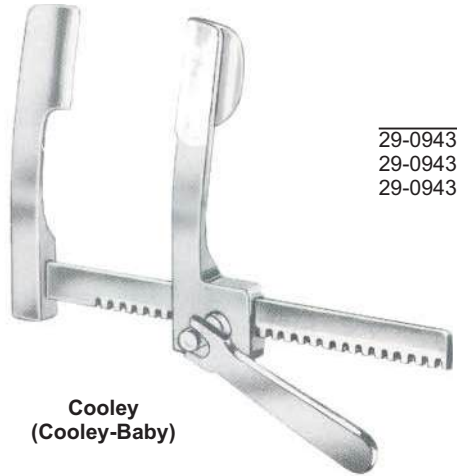

	a	b	c
29-09438-01	12 mm	17 mm	75 mm
29-09438-02	16 mm	30 mm	105 mm
29-09438-03	37 mm	49 mm	200 mm

**Cooley
(Cooley-Baby)**



	a	b	c
29-09442-01	10.5 mm	32 mm	65 mm
29-09442-02	12 mm	45 mm	70 mm
29-09442-03	15 mm	60 mm	120 mm

Castaneda



	a	b	c
29-09446-01	15 mm	15 mm	75 mm
29-09446-02	31 mm	31 mm	100 mm

Finocchietto-Baby-Haight



Finocchietto

	a	b	c
29-09450-01	38 mm	44 mm	135 mm
29-09450-02	52 mm	62 mm	135 mm
29-09450-03	85 mm	65 mm	135 mm



Burford
With 2 Pairs of Blades

For Child	a	b	c
29-09454-00	48 mm	42 mm	135 mm
29-09454-01	34 mm	42 mm	135 mm
29-09454-02	65 mm	62 mm	180 mm
29-09454-03	47 mm	62 mm	260 mm
	65 mm	62 mm	300 mm
	47 mm	62 mm	



Lemmon
29-09458-18
18 cm/7"



Sellors
29-09462-19
19 cm/7½"



Bailey-Baby
29-09466-14
14 cm/5½"



Bailey
29-09470-16
16 cm/6¼"



Bailey-Gibbon
29-09474-16
16 cm/6¼"



Allison
29-09478-25 25.5 cm/10"
29-09478-30 30.0 cm/12"

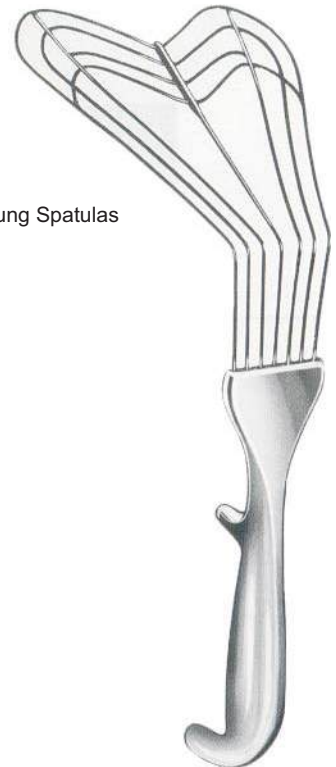

Lung Spatulas

29-09482-30
30 cm/12"



Price-Thomas
29-09486-22
22 cm/8¾"

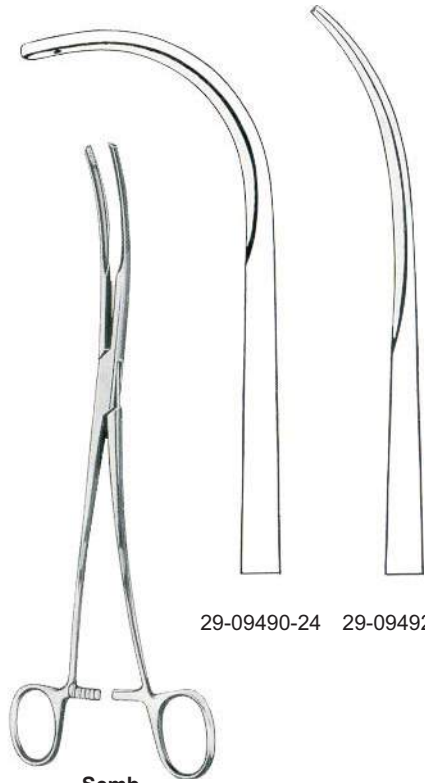

Semb
24 cm/9½"

29-09490-24 29-09492-24

Lung grasping forceps



Lovlace
29-09496-20
20 cm/8"



Lovlace
29-09500-20
20 cm/8"



Fig. 1

Fig. 2



Satinisky
26.5 cm/10½"
Fig. 1
29-09504-01
29-09504-02
Fig. 2



29-09508-01
29-09508-02

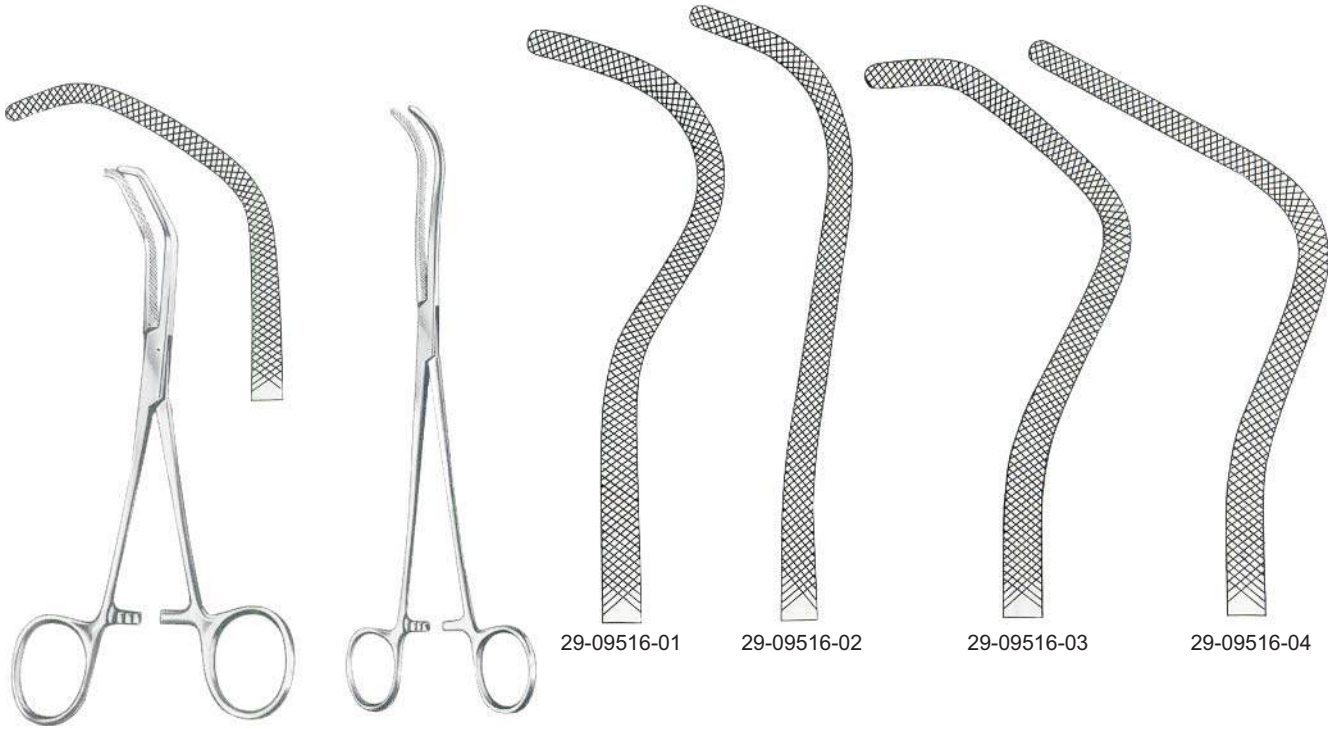

Baby-Satinsky
29-09512-15
15 cm/6"

Harken
24 cm/9½"

29-09516-01

29-09516-02

29-09516-03

29-09516-04

Pinsmed AtraumaTC

Atrauma tissue forceps



De Bakey

Wide

29-09520-15	15.0 cm/6"	1.5 mm
29-09520-19	19.5 cm/7½"	1.5 mm
29-09520-24	24.0 cm/9½"	1.5 mm



De Bakey

	1.2 mm	2.0 mm	Wide
29-09524-18		29-09526-18	18 cm/7"
29-09524-21		29-09526-21	21 cm/8¼"

Pinsmed Atrauma



Cooley

29-09530-15	15.0 cm/6"
29-09530-19	19.5 cm/7½"
29-09530-24	24.0 cm/9½"



De Bakey

Wide	1.5 mm	2.0 mm	2.7 mm	3.5 mm
16 cm/6¼"	29-09534-16	29-09536-16	29-09538-16	29-09540-16
20 cm/8"	29-09534-20	29-09536-20	29-09538-20	29-09540-20
24 cm/9½"	29-09534-24	29-09536-24	29-09538-24	29-09540-24
30 cm/12"	29-09534-30	29-09536-30	29-09538-30	29-09540-30



De Bakey

Wide	2.0 mm
29-09543-16	
29-09543-20	
29-09543-24	
29-09543-30	



De Bakey

Setting forceps



29-09546-23
23 cm/9"



29-09550-07
29-09550-08
29-09550-10
29-09550-12

7.5 cm/3"
8.5 cm/3½"
10.5 cm/4¼"
12.0 cm/4¾"



29-09551-07
29-09551-08
29-09551-10
29-09551-12



29-09554-03
3.5 cm/1½"



29-09555-03
3.5 cm/1½"



29-09558-04
4.5 cm/1¾"



29-09559-04
4.5 cm/1¾"



De-Bakey
29-09562-05
5.0 cm/2"



De-Bakey
29-09563-05
5.0 cm/2"



De Bakey



Glover		Glover	
29-09566-06	6 cm/2½"	29-09567-06	
29-09566-07	7 cm/2¾"	29-09567-07	
29-09566-09	9 cm/3½"	29-09567-09	
29-09566-11	11 cm/4½"	29-09567-11	



Glover
29-09571-06
5 cm/2"



De Bakey-Satinsky
29-09575-07
7 cm/2¾"



De Bakey



De Bakey-Carotid
29-09579-09
9 cm/3½"



De Bakey-Satinsky
29-09583-10
10 cm/4"

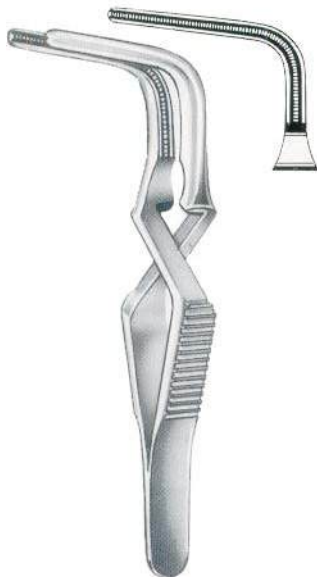

Santulli
29-09587-07
7 cm/2¾"



Gregory-Soft
29-09591-09 29-09593-11
9 cm/3½" 11 cm/4½"



De Bakey

Coarctation Clamps



**Potts
(De Bakey)**

29-09596-21
21 cm/8¼"



29-09596-22
22 cm/8¾"



**Potts
(De Bakey)**

29-09599-21
21 cm/8¼"



29-09599-22
22 cm/8¾"



Potts

29-09601-21
21 cm/8¼"



29-09601-22
22 cm/8¾"





De Bakey

Anastomosis Clamps



Glover
(Potts)

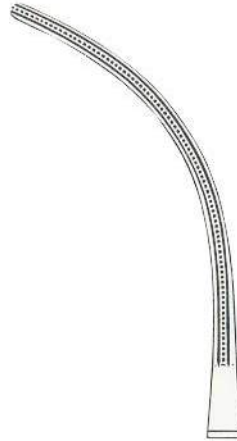

29-09605-21
21 cm/8 1/4"



29-09605-22
22 cm/8 1/4"

Dissecting and
Ligature Forceps



De Bakey



29-09609-20
20 cm/8"



29-09609-24
24 cm/9 1/2"



De Bakey



29-09613-20
20 cm/8"



29-09615-18
18 cm/7 1/2"



De Bakey



Leland-Jones



29-09618-01
19.5 cm/7½"

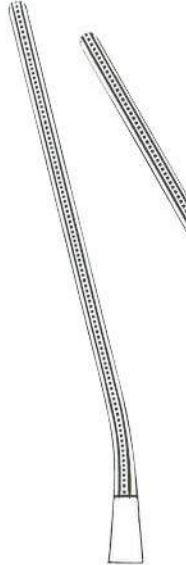

29-09618-02
19.5 cm/7½"

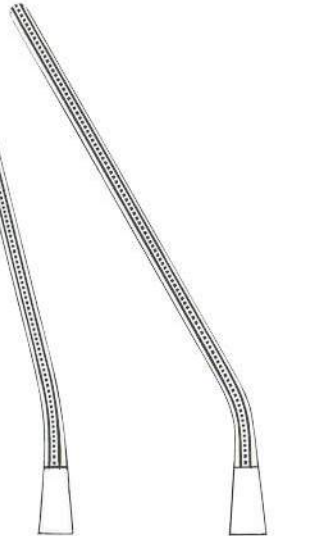

29-09618-03
19.5 cm/7½"



Leland-Jones
29-09621-18
18 cm/7"



De Bakey-Bainbirdge



29-09624-15
15 cm/6"



29-09624-18
18 cm/7"



29-09625-15
15 cm/6"



29-09625-18
18 cm/7"



De Bakey
29-09629-20
20 cm/8"





De Bakey

Aortic Aneurysm Clamps



De Bakey



29-09633-24
24 cm/9½"

29-09633-27
27 cm/10½"

29-09633-31
31 cm/12¼"

29-09633-33
33.5 cm/13¼"



De Bakey

Aortic Aneurysm Clamps



De Bakey
29-09637-28
28 cm/11"



29-09641-30
30 cm/12"



De Bakey

Aortic Clamps

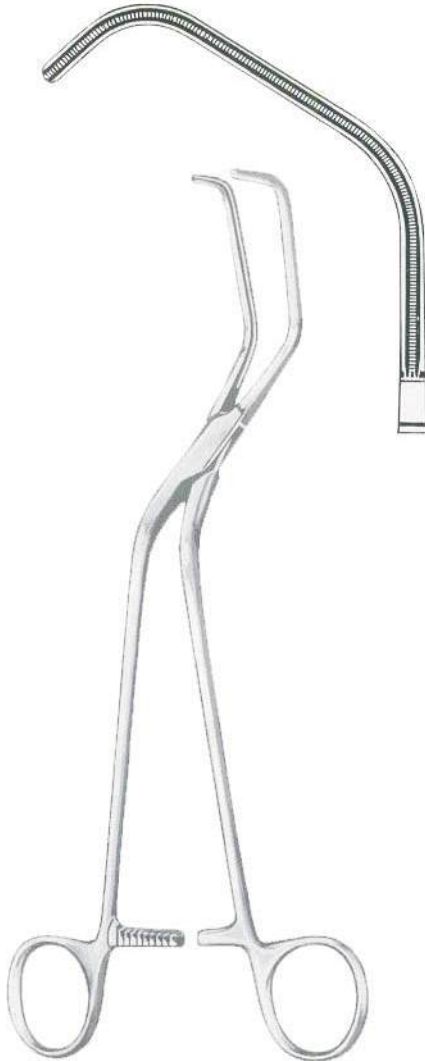

Ochsner
29-09645-23
23.5 cm/9¼"



Dietrich
29-09649-21
21 cm/8¼"



De Bakey

Auricle Clamp



Harken



29-09653-01
24 cm/9½"



29-09653-02
24 cm/9½"



29-09653-03
24 cm/9½"



29-09653-04
24 cm/9½"



De Bakey

Bronchus Clamps

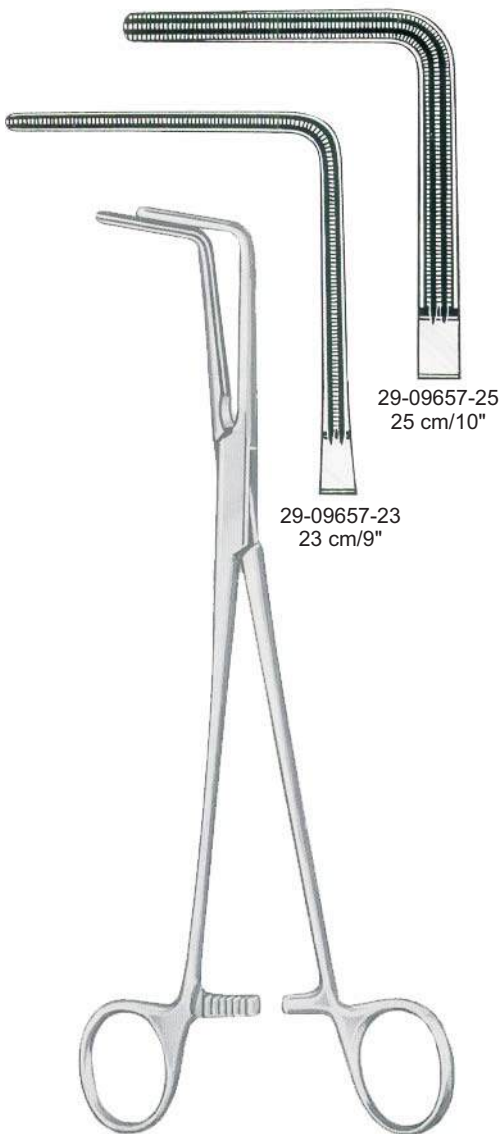

29-09657-23
23 cm/9"

Lees



Lees
29-09661-25
25 cm/10"



De Bakey

Aortic Clamp

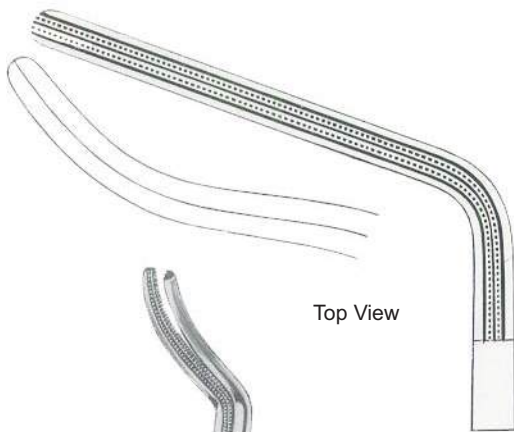

Top View



De Bakey
29-09665-27
27 cm/10½"

Ligature Clamps

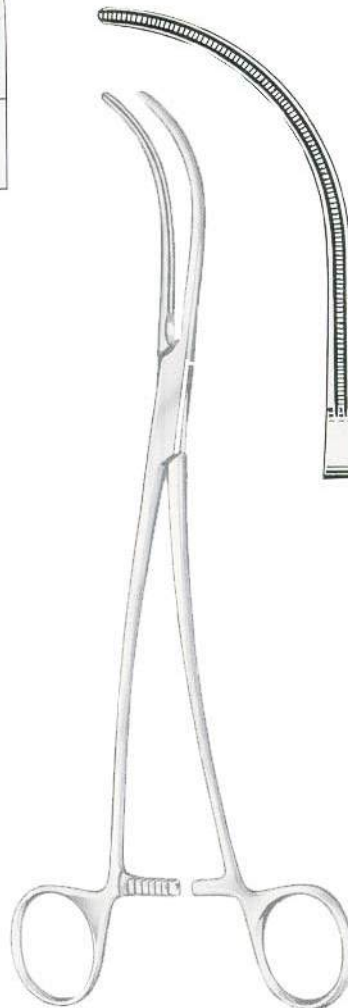

De Bakey
29-09669-24
24 cm/9½"



De Bakey
29-09673-24
24 cm/9½"



De Bakey

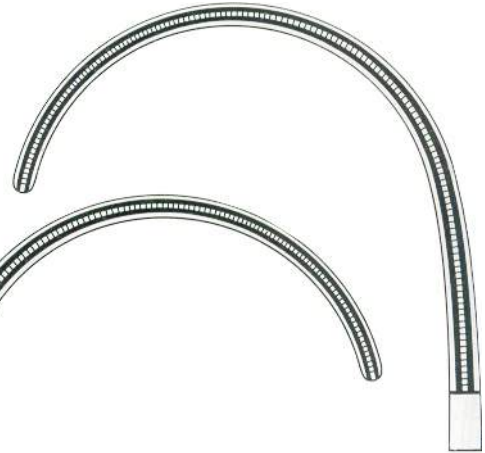

29-09681-02

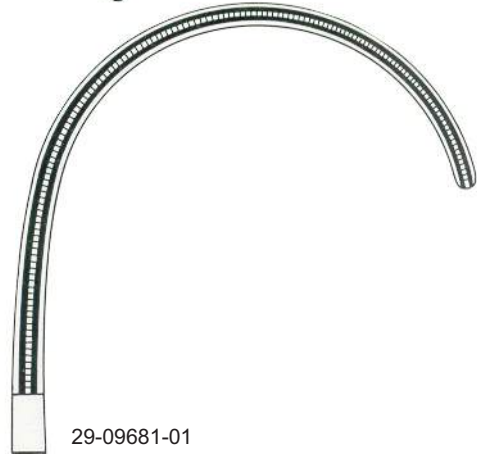

29-09681-01

Ligature clamp,
Aortic clamp



De Bakey
29-09677-26
26.5 cm/10½"



De Bakey-Semb
29-09677-25
25 cm/10"



De Bakey-Semb

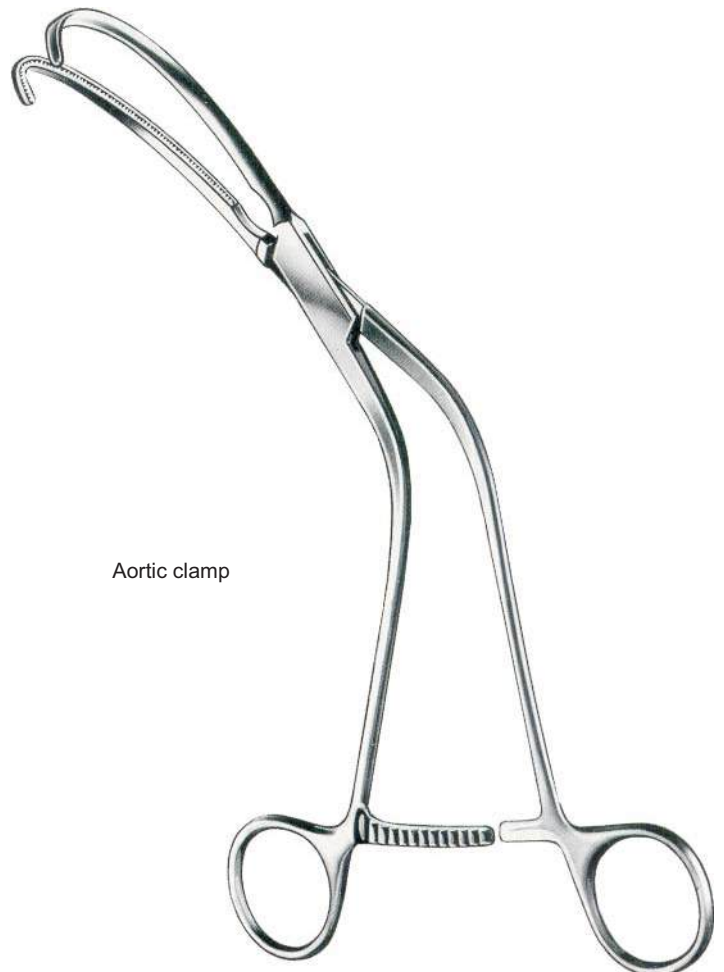

Aortic clamp

Weber
26 cm/10¼"



De Bakey

Tangential occlusion clamps



Satinsky/De Bakey



- | | | | | | |
|-----------------------------------|-------------------------|--------------------------|---------------------------|---------------------------|--------------------------|
| Set of 5 purchase.
29-09685-00 | 29-09685-20
20 cm/8" | 29-09685-25
25 cm/10" | 29-09685-26
26 cm/10¼" | 29-09685-27
27 cm/10½" | 29-09885-28
28 cm/11" |
|-----------------------------------|-------------------------|--------------------------|---------------------------|---------------------------|--------------------------|



Glover

- | | |
|-------------|-------------|
| 29-09689-01 | 19.5 cm/7¾" |
| 29-09689-02 | 21.0 cm/8¼" |

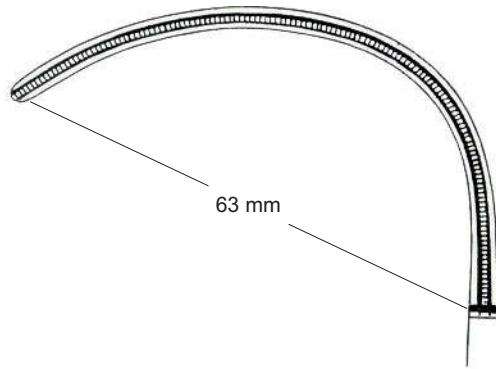

63 mm

29-09689-01

Anastomosis

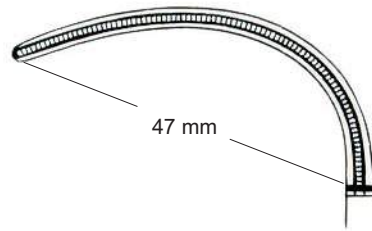

47 mm

29-09689-02



De Bakey



Lambert-Kay
21 cm/8¼"



29-09695-21

29-09693-21

Aortic anastomosis clamps



De Bakey
29-09699-17
17 cm/6¾"



Beck
29-09703-17
17 cm/6¾"

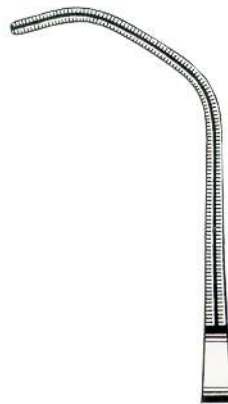



De Bakey



De Bakey
29-09707-16
16 cm/6 1/4"

Graduated

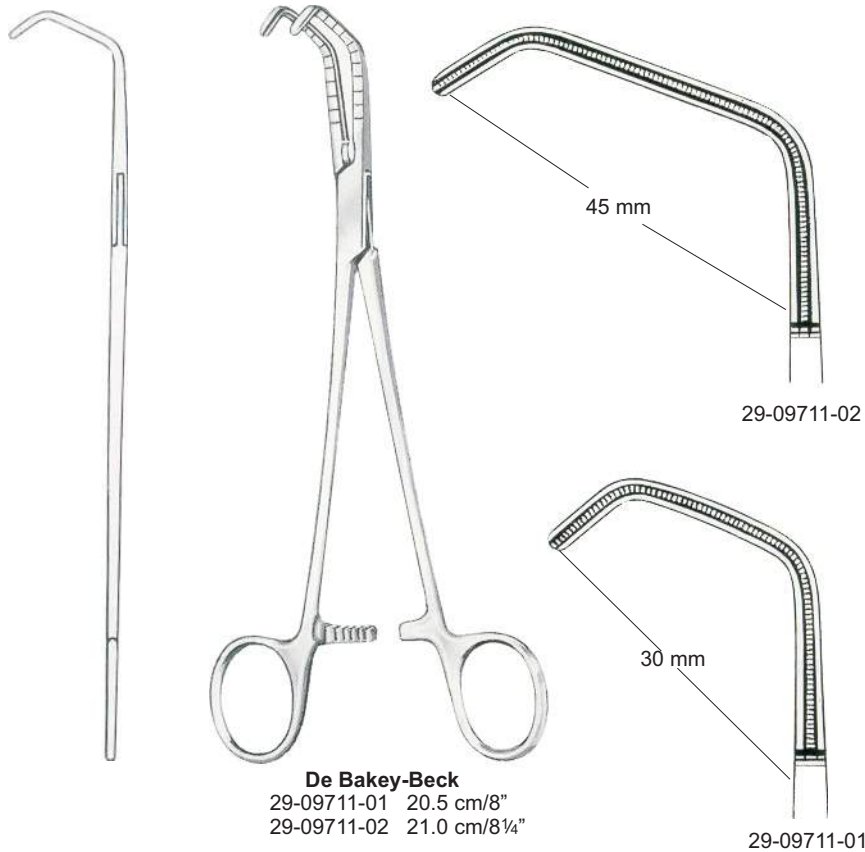

De Bakey-Beck
29-09711-01 20.5 cm/8"
29-09711-02 21.0 cm/8 1/4"

29-09711-02

29-09711-01



29-09714-00



15°
29-09715-15



30°
29-09715-30

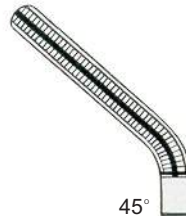

45°
29-09715-45



90°
29-09715-90



29-09718-00



15°
29-09719-15



30°
29-09719-30



45°
29-09719-45



90°
29-09719-90



Dardik
17 cm/6³/₄"



De Bakey



Multi purpose clamps



De Bakey

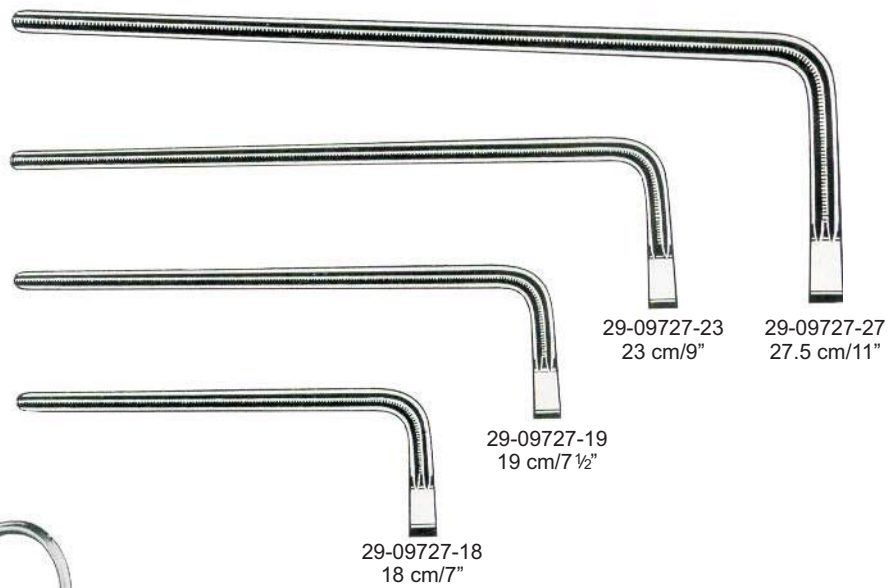



Aortic anastomosis clamps

Morris-De Bakey



29-09731-18
18 cm/7"

29-09731-20
20 cm/8"

29-09731-23
23 cm/9"

29-09731-25
25 cm/10"



Glover
29-09735-24
24.5 cm/9¾"



De Bakey

Aorta aneurysm clamps



De Bakey-Bahnson



29-09739-24
24.5 cm/9¾"

29-09739-25
25.5 cm/10"

29-09739-26
26.5 cm/10½"

Coarctation clamps



	Straight	cm/in	Curved
	29-09742-21	21.5 cm/8½"	29-09743-21
	29-09742-23	23.0 cm/9"	29-09743-23
	29-09742-27	27.0 cm/10½"	29-09743-27
	29-09742-31	31.5 cm/12½"	29-09743-31



De Bakey

Atrauma hemostatic forceps



Mosquito
12 cm/4¾"

29-09746-12

29-09747-12



De Bakey-Pean



29-09750-14
14 cm/5½"



29-09750-16
16 cm/6¼"



29-09750-18
18 cm/7"



29-09750-20
20 cm/8"



29-09751-14
14 cm/5½"



29-09751-16
16 cm/6¼"



29-09751-18
18 cm/7"



29-09751-20
20 cm/8"

Multi purpose clamps



De Bakey



De Bakey-Rankin

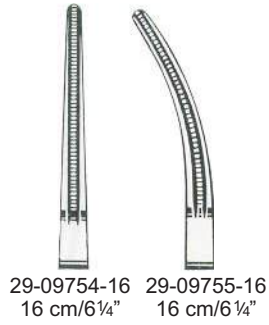

29-09754-16 16 cm/6¼"
29-09755-16 16 cm/6¼"



Cooley

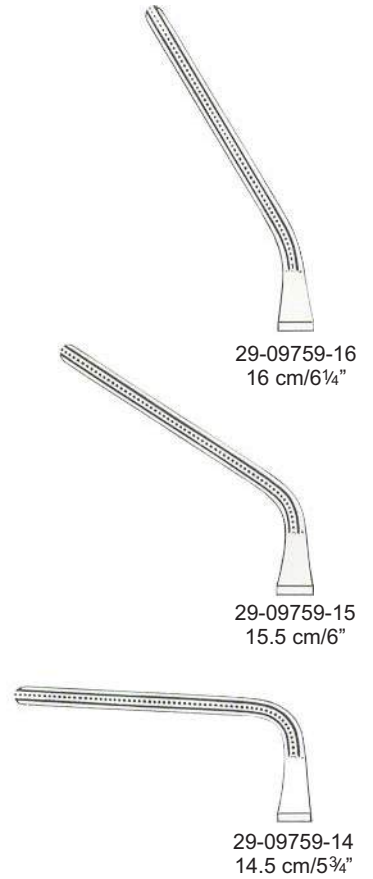

29-09759-16
16 cm/6¼"

29-09759-15
15.5 cm/6"

29-09759-14
14.5 cm/5¾"



De Bakey
29-09762-17
17 cm/6¾"

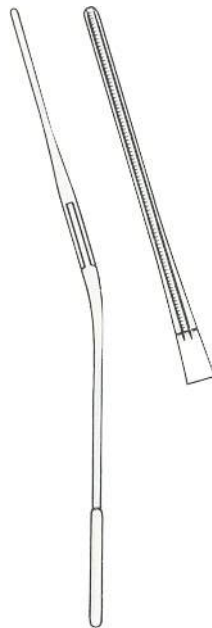

29-09763-17



29-09765-17



29-09767-17



De Bakey

Ligature Clamps

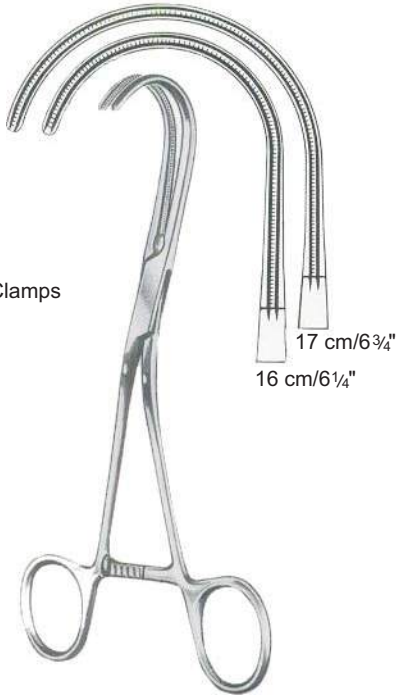

29-09771-16 16cm/6¼"
29-09771-17 17cm/6¾"

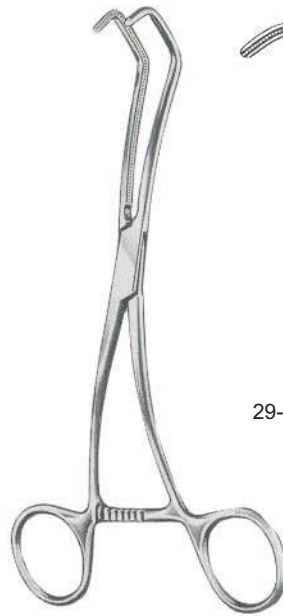

Derra-De Bakey
17 cm/6¾"

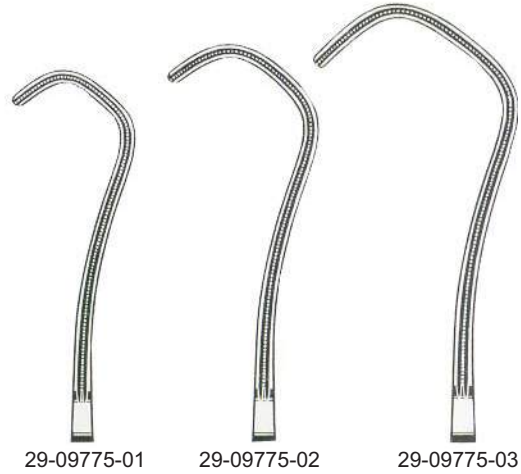

Anastomosis Clamps

Profunda Clamps



Gregory



29-09779-14
14 cm/5½"



29-09779-16
16 cm/6¼"

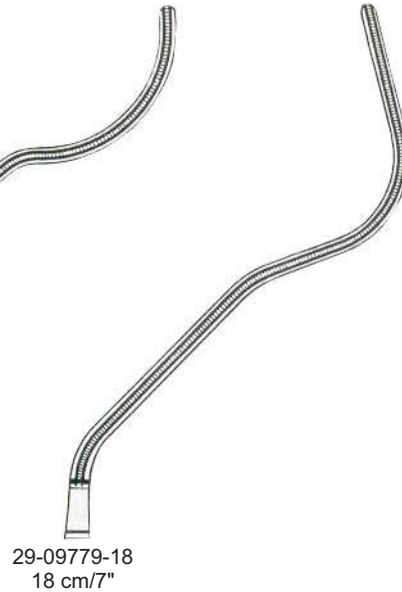

29-09779-18
18 cm/7"



De Bakey
29-09782-12
12 cm/4¾"



De Bakey



29-09783-10
10 cm/4"



29-09783-11
10.5 cm/4½"



De Bakey

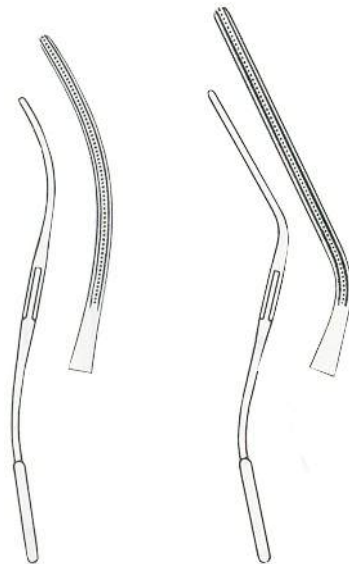

29-09783-12
12 cm/4¾"

29-09783-13
13 cm/5"

Carotid Clamps



Javid
29-09787-18
18 cm/7"



Javid
29-09787-19
19 cm/7½"



Cooley

Charriere (French)	Length cm	
24	16	29-09789-24
26	16	29-09789-26
28	20	29-09789-28
30	20	29-09789-30
32	20	29-09789-32
36	20	29-09789-36



Cooley

Coarctation Clamps



Cooley
29-09792-17
17 cm/6¾"

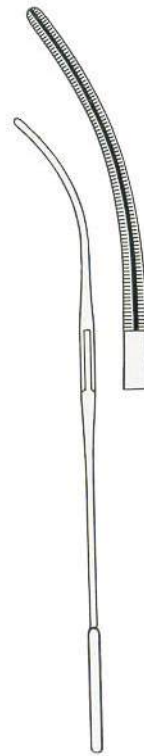

29-09793-17
17 cm/6¾"



29-09795-17
17 cm/6¾"

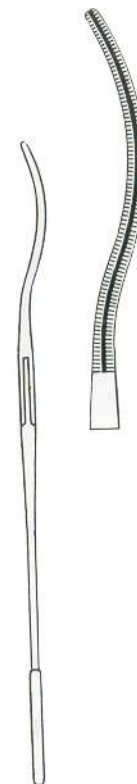

29-09797-17
17 cm/6¾"



Cooley



Cooley
29-09799-20
20 cm/8"



Cooley



29-09801-03
17 cm/6¾"

29-09801-02
15.5 cm/6"



29-09801-01
15 cm/6"



Cooley
29-09803-17
17 cm/6¾"

Anastomosis clamps



Cooley



Cooley



29-09807-01
16.5 cm/6½"

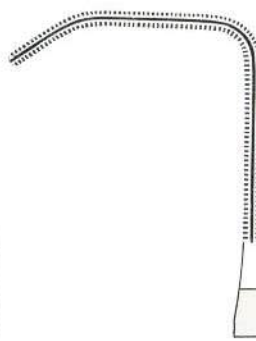

29-09807-02
16.5 cm/6½"

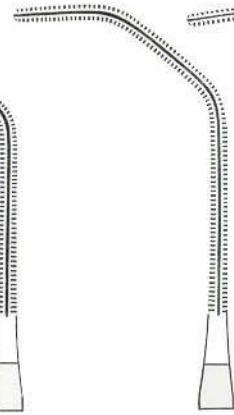

29-09807-03
17.5 cm/7"

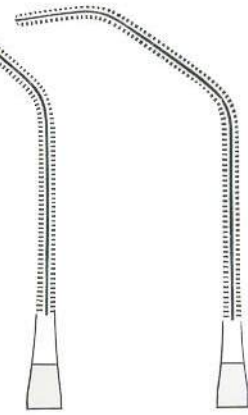

29-09807-04
17.5 cm/7"

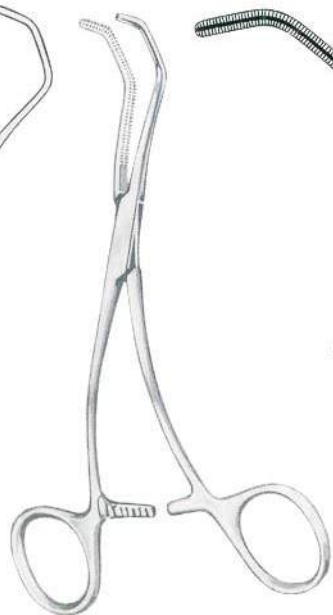

Cooley
29-09811-16
16 cm/6¼"

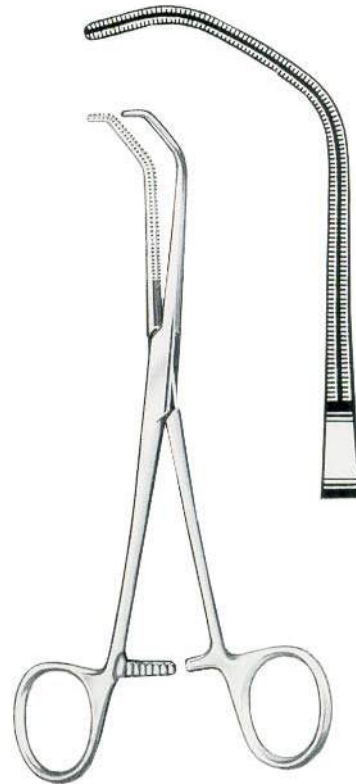

Beck
29-09815-17
17 cm/6¾"



Cooley



Cooley-Derra



29-09819-16
16 cm/6 1/4"

29-09819-17
17 cm/6 3/4"

29-09819-18
18 cm/7"



Cooley

29-09823-16 16 cm/6 1/4"
29-09823-17 17 cm/6 3/4"



16 cm/6 1/4"

17 cm/6 3/4"

Ligature clamps



Cooley
14 cm/5½"



Cooley
29-09830-14
14 cm/5½"



Cooley
29-09833-14
14 cm/5½"



Cooley
29-09837-14
14 cm/5½"





Fig.



Fig.

Fig.	Straight
1	29-09842-01
2	29-09842-02
3	29-09842-03
4	29-09842-04
5	29-09842-05
6	29-09842-06
7	29-09842-07
8	29-09842-08
9	29-09842-09

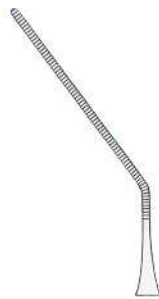

Fig.	Angled
1	29-09843-01
2	29-09843-02
3	29-09843-03
4	29-09843-04
5	29-09843-05
6	29-09843-06
7	29-09843-07
8	29-09843-08
9	29-09843-09



Fig.	Curved
1	29-09845-01
2	29-09845-02
3	29-09845-03
4	29-09845-04
5	29-09845-05
6	29-09845-06
7	29-09845-07
8	29-09845-08
9	29-09845-09





29-09847-01
13 cm/5"



29-09847-02
13 cm/5"



29-09847-03
13 cm/5"



Castaneda



29-09847-04
15 cm/6"



29-09847-05
15 cm/6"

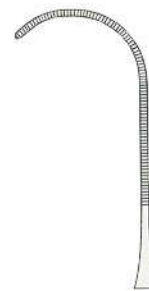

29-09847-06
15 cm/6"

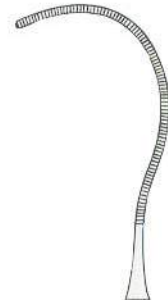

29-09847-07
15 cm/6"



Cooley
29-09849-01
25 cm/10"



Cooley
29-09849-02
33 cm/13"



Cooley
29-09849-03
30 cm/12"



Cooley
29-09849-04
30 cm/12"



Cooley
29-09849-05
35 cm/13¾"

Tourniquets



Rumel-Belmont
29-09851-32 3.2 mm Ø
29-09851-64 6.4 mm Ø

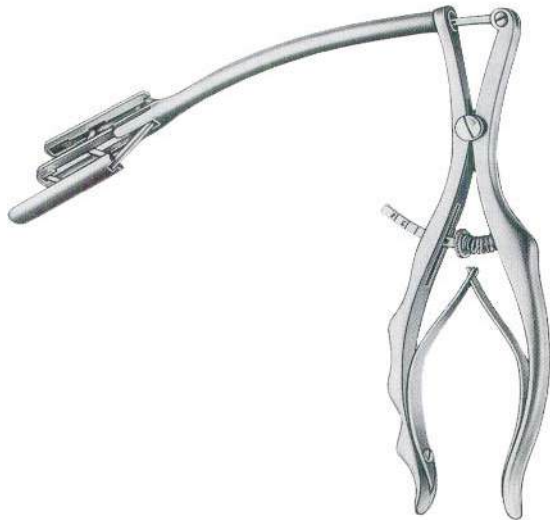

Cooley
29-09853-00



Gerbode
29-09854-00



Tubbs
29-09855-00



De Bakey

mm Ø	19 cm/7 1/2"	35 cm/14"
0.5	29-09857-05	29-09858-05
1.0	29-09857-10	29-09858-10
1.5	29-09857-15	29-09858-15
2.0	29-09857-20	29-09858-20
2.5	29-09857-25	29-09858-25
3.0	29-09857-30	29-09858-30
3.5	29-09857-35	29-09858-35
4.0	29-09857-40	29-09858-40
4.5	29-09857-45	29-09858-45
5.0	29-09857-50	29-09858-50
7.0	29-09857-70	29-09858-70
9.0	29-09857-90	29-09858-90

Malleable

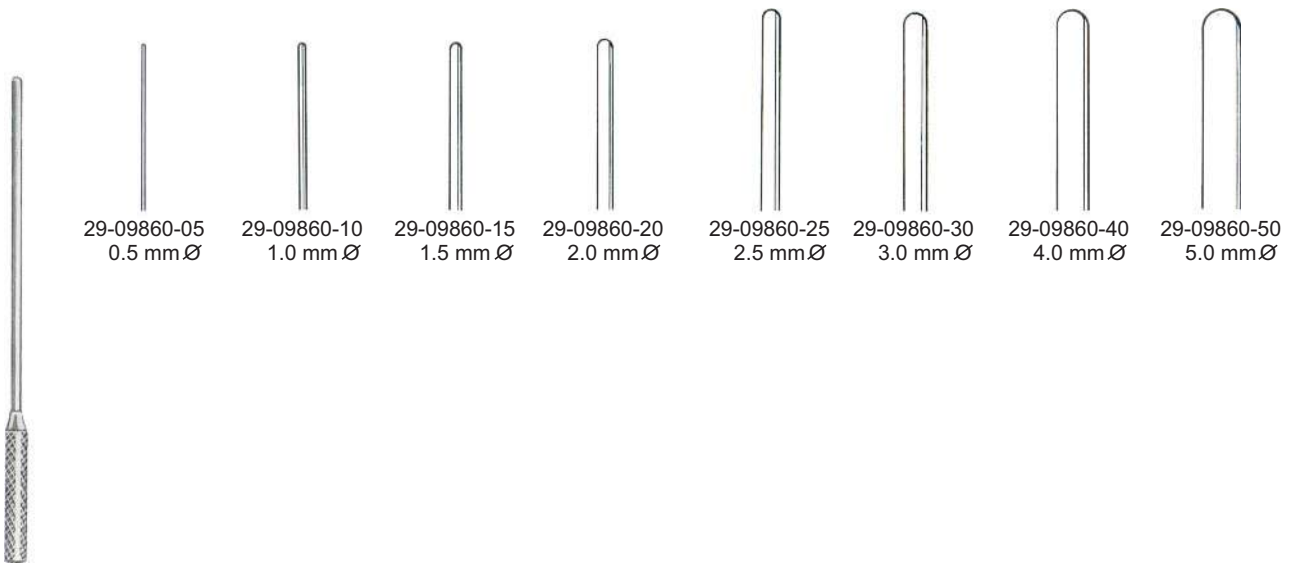

29-09860-05 0.5 mm Ø 29-09860-10 1.0 mm Ø 29-09860-15 1.5 mm Ø 29-09860-20 2.0 mm Ø 29-09860-25 2.5 mm Ø 29-09860-30 3.0 mm Ø 29-09860-40 4.0 mm Ø 29-09860-50 5.0 mm Ø

Cooley
13 cm/5"



Children
30-09862-07
7 cm/2¾"

Weiss

Adults
30-09862-09
9 cm/3½"



Children
30-09864-07
7 cm/2¾"

Weiss

Adults
30-09864-09
9 cm/3½"

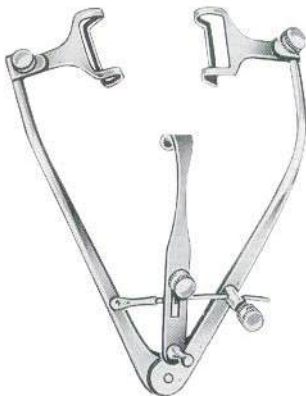

Park
30-09868-08
8 cm/3¼"

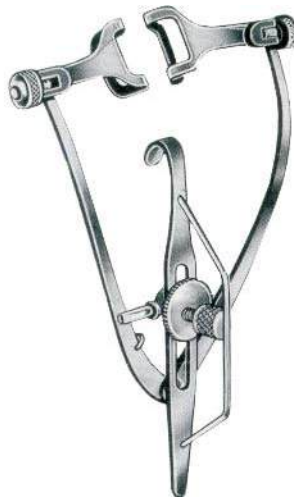

Park-Guyton
30-09870-08
8 cm/3¼"



Park-Maumenee
30-09872-08
8 cm/3¼"



Children
30-09874-03
3 cm/1¼"

Barraquer (Colibri)

Adults
30-09874-04
4 cm/1½"



Barraquer
30-09876-04
4 cm/1½"



Bowman
30-09878-07
7 cm/2¾"



Sauer
30-09880-03
3 cm/1¼"



Goldstein
30-09884-03
3 cm/1¼"



Pley
30-09888-06
6 cm/2¼"

For left eye

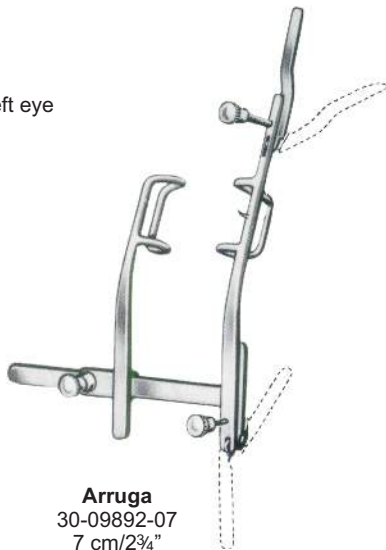

Arruga
30-09892-07
7 cm/2¾"

For right eye

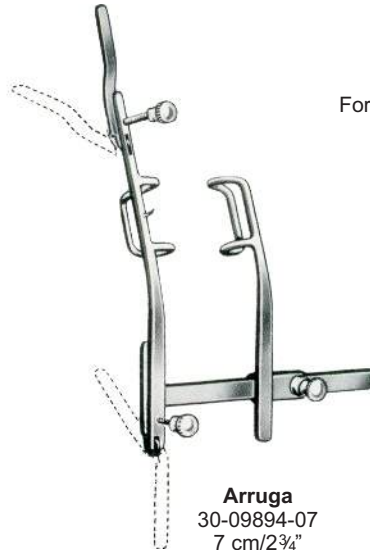

Arruga
30-09894-07
7 cm/2¾"



Mellinger-Axenfeld
30-09898-07
7 cm/2¾"



Mellinger-Axenfeld
30-09900-07
7 cm/2¾"

Children
30-09904-05
5 cm/2¾"



Mellinger
Adults
30-09904-07
7 cm/2¾"



Children	Mellinger Beard	Adults
30-09908-05		30-09908-07
5 cm/2"		7 cm/2¾"



Knapp Clark
30-09912-08
8 cm/3¼"



Children	Graefe	Adults
30-09916-06		30-09916-09
6 cm/2½"		9 cm/3½"



Children	Cook	Adults
30-09920-04		30-09920-05
4 cm/1½"		5 cm/2"



Lancaster
30-09924-08
8 cm/3¼"



Children	Williams	Adults
30-09928-07		30-09928-08
7 cm/2¾"		8 cm/3¼"



Lister-Burch
30-09932-08
8 cm/3¼"



Weiss
30-09936-08
8 cm/3¼"



Murdock
30-09940-05
5 cm/2"



Mueller
30-09944-07
7 cm/2¾"



Critchett
30-09948-06
6 cm/2½"



Castroviejo
30-09952-08
8 cm/3¼"



Stevenson
30-09956-07
7 cm/2¾"



Agricola
30-09960-04
4 cm/1½"



Schepens
30-09964-13
13 cm/5"



Desmarres
30-09968-13
13 cm/5"



8 mm

Conway
30-09972-13
13 cm/5"



Desmarres
13 cm/5"



30-09976-12
12 mm



30-09976-14
14 mm



30-09976-16
16 mm



30-09976-18
18 mm

Lid plate



Jaeger
30-09980-11
11 cm/4 1/2"

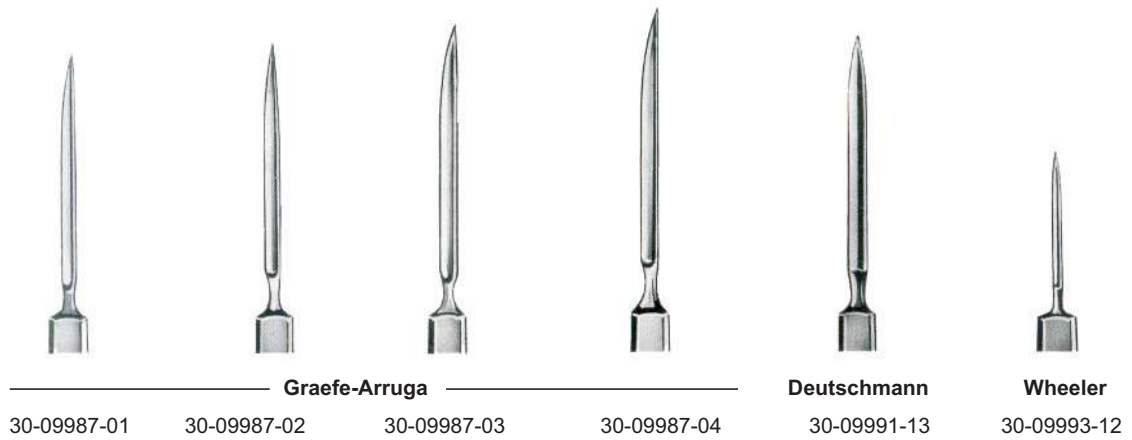
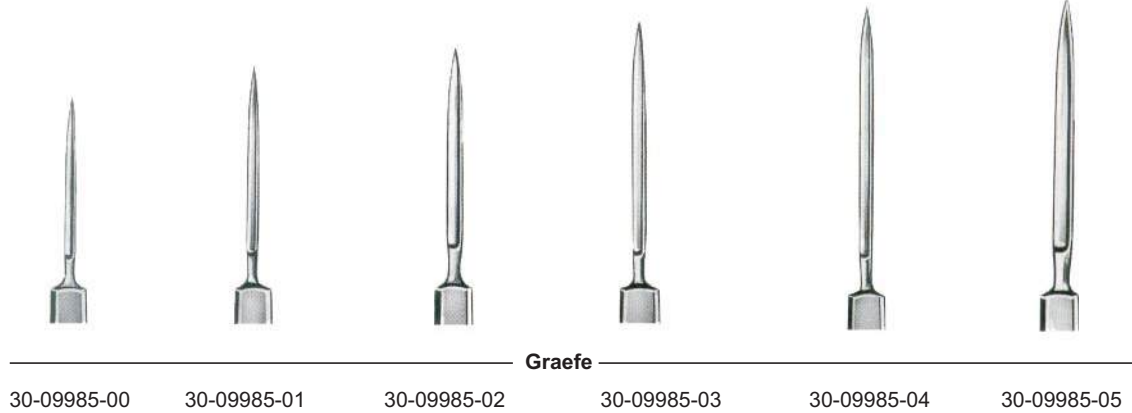
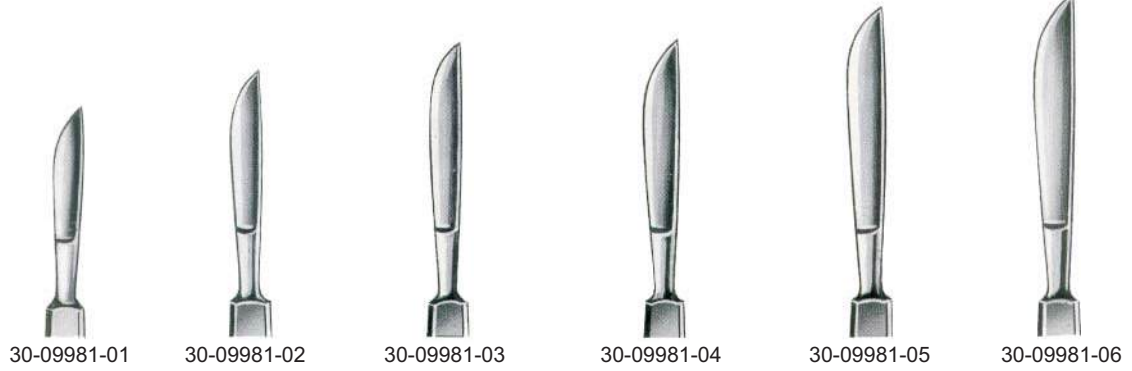



Jaeger
30-09997-01



30-09997-02



30-09997-03



30-09997-04



30-09999-01



30-09999-02



30-09999-03



30-09999-04



30-10001-01



30-10001-02



30-10001-03



30-10001-04



30-10003-01



30-10003-02



30-10003-03



30-10003-04

Jaeger-Grieshaber



30-10005-01



30-10005-02



30-10005-03



30-10005-04

Jaeger-Grieshaber

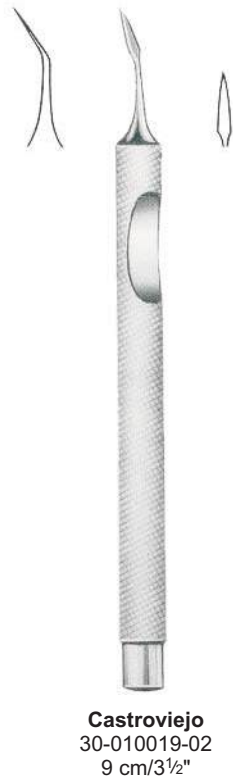
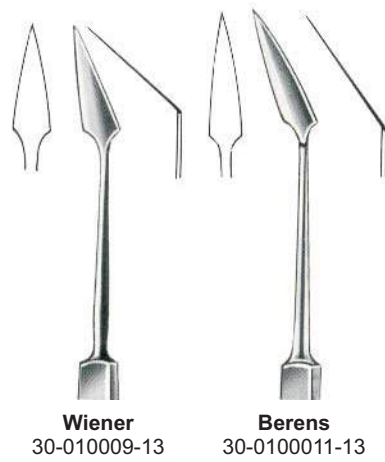



Mod. Hamburg
30-010023-12



Graefe
30-010025-13



30-010027-01



Weber
30-010027-02



30-010027-03



Bowman
30-010029-04
0.4 mm



Bowman
30-010029-05
0.5 mm



Bowman
30-010029-06
0.6 mm



Bowman
30-010029-07
0.7 mm



Bowman
30-010029-08
0.8 mm



Left **Bowman** Right
30-010031-01 30-010031-02



30-010033-01



Knapp
30-010033-02



30-010033-03



30-010035-05
5 mm



Ziegler
30-010035-06
6 mm



30-010035-07
7 mm



Dean
30-010037-13



Zigler
30-010039-11
3½ mm



Sato
30-010041-12



Sichel
30-010043-13



Graefe
30-010045-13



Graefe
30-010047-13



30-010049-01



Kuhnt
30-010049-02



30-010049-03



30-010049-04



Paton
30-010051-12



Elsching
30-010053-13



Took
30-010055-12



30-010057-01



Desmarres
30-010057-02



30-010057-03



Gill
30-010059-12



Anderson-Critchett
30-010061-12



Lundsgaard
30-010063-12



Guyton-Lundsgaard
30-010065-12



Barken
30-010067-12



Scheie
30-010069-12



Burch
30-010071-12



30-010073-12



30-010075-12



30-010077-12



30-010079-12



30-010081-12



30-010083-12



Schweiz. Mod.
30-010085-12



30-010087-13



30-010089-13



Levinson
30-010091-13



Alvis
30-010093-12



Francis
30-010095-12



**La Force
(Golf-Club)**
30-010097-12



Davis
30-010099-13



Dix
30-010101-13



Ellis
30-010103-11



Plango
30-010105-12



Nicati
30-010107-12



Walton
30-010109-12



Walton
30-010111-12



Meyer
30-010113-12



Green
30-010115-13



Rollet
30-010117-12



Graefe
30-010119-13



Graefe
30-010121-19



Graefe
30-010123-13



**Becker
Melleable**
30-010125-13



Tuebingen
30-010127-13



Mod. Bonn
30-10129-14
14 cm/5½"



Hirschmann
Blunt
30-10132-10



Graefe
Sharp
30-10133-12



Graefe
Blunt
30-10136-12



Knolle
30-10140-01

◀ Blunt ▶



Jeffe-Knolle
30-10140-02



O'Connor
30-10144-12



Wiener

Sharp
30-10047-13

Blunt
30-10148-13



Hirschmann
30-10152-13



Graefe
30-10156-13



McGannan
30-10160-13
13 cm/5"



Meyer-Schwickerath
30-10164-13
13 cm/5"



Jaeger
30-10168-01



Jaeger
30-10168-02



Left Arruga
30-10172-01



Right
30-10172-02



Jameson
30-10176-12



Culler
30-10180-12



Green
30-10184-13



Guthrie
30-10188-12



Guthrie
30-10190-13



Berens
30-10194-12



Knapp
Blunt
30-10198-13



Rollet
Sharp
30-10201-12



Rollet
30-10204-12



Fink
Blunt
30-10208-12



Right
30-10212-01

Left
30-10212-02

10.5 cm/4 1/4"



Knapp-Rollet
30-10216-02



Flexible
30-10216-03



30-10216-04



Axenfeld

Sharp
30-10219-14

Blunt
30-10220-14



Axenfeld

Sharp
30-10223-14

Blunt
30-10224-14



Paul
30-10228-12



Sautter
30-10232-01



Sautter
30-10232-02



Sautter
30-10232-03



Arruga
30-10236-13



Stevens
30-10240-14



Stevens
30-10244-12



Graefe
30-10248-01



Graefe
30-10248-02



Graefe
30-10248-03



Wecker
30-10251-13



Wecker
30-10252-13



Stock
30-10255-13



Stock
30-10257-13



Culler
30-10262-13



Suker
30-10266-14

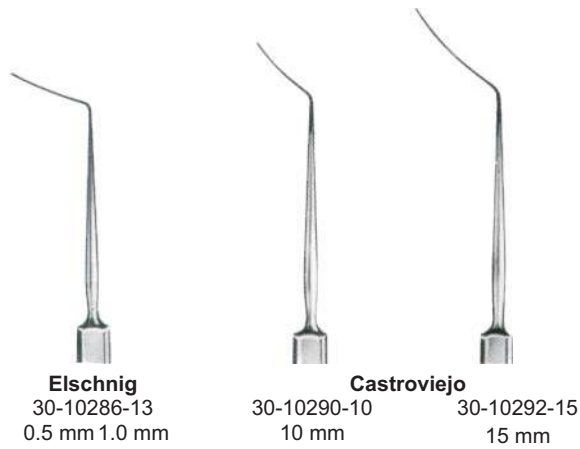
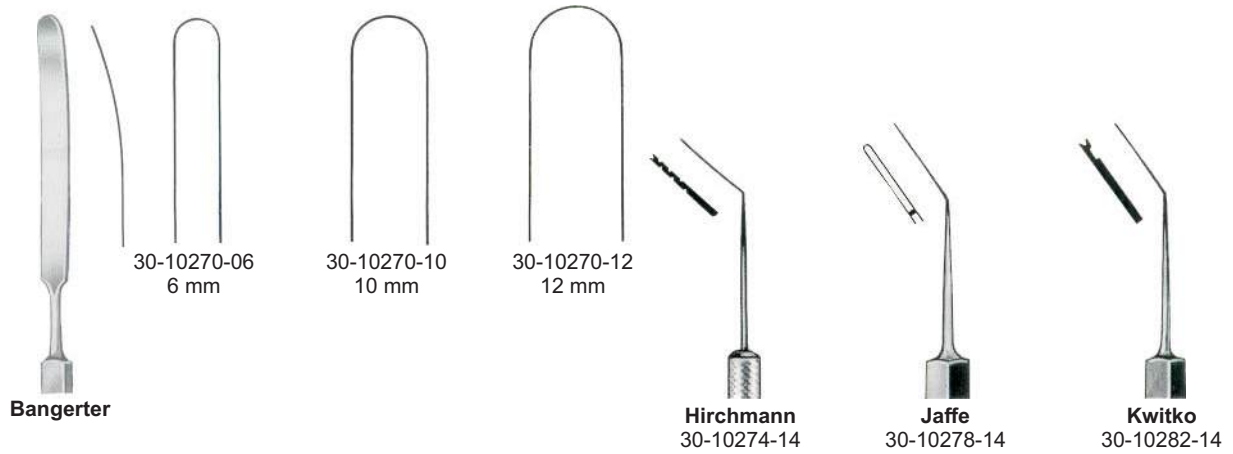

Width of Spatula

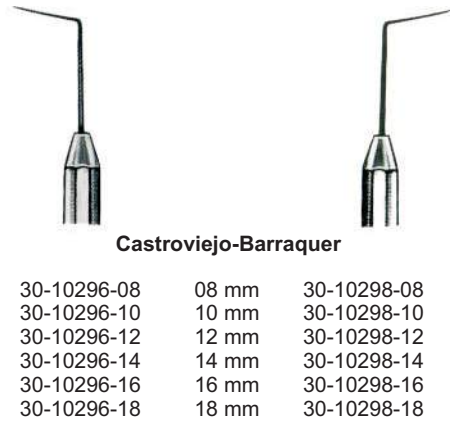
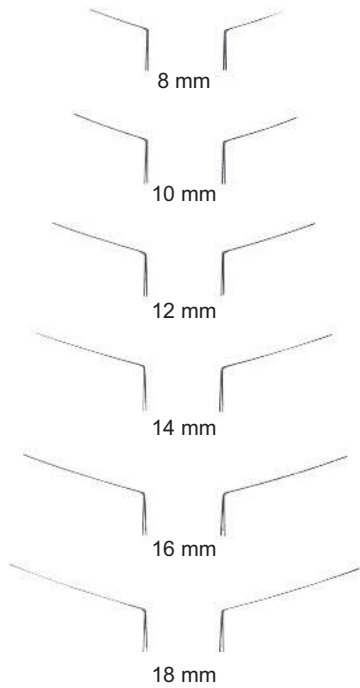





Enucleation Scoops

Small
30-10348-16

Large
30-10348-20

Wells

Chalazion Curettes



Meyhoefer

30-10352-05
0.5 mm Ø

30-10352-10
1.0 mm Ø

30-10352-15
1.5 mm Ø

30-10352-18
1.8 mm Ø

30-10352-20
2.0 mm Ø

30-10352-25
2.5 mm Ø

30-10352-35
3.5 mm Ø



Meyhoefer
30-10352-40
4.0 mm Ø

Meyhoefer
30-10352-45
4.5 mm Ø

30-10356-10
1.0 mm Ø

30-10356-20
2.0 mm Ø

Hebra
30-10356-25
2.5 mm Ø

30-10356-30
3.0 mm Ø

30-10356-35
3.5 mm Ø

Exenteration Scoops

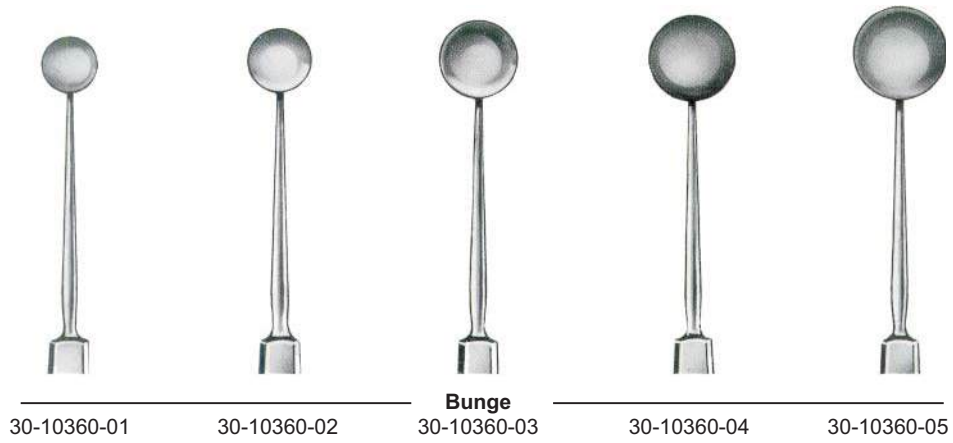

Irrigating Cannulas

Straight



Binkhorst
30-10372-01
22 gauge

Right



Binkhorst
30-10372-02
22 gauge

Left



Binkhorst
30-10372-03
22 gauge

Probe Point



Bonn
30-10372-04
20 gauge



Bonn
30-10372-05
19 gauge



Hamburg
30-10372-06
23 gauge



Simcoe
30-10376-01
23 gauge

Irrigation/Aspiration Cannulas



Gills-Welsh
30-10376-02
25/23 gauge

Cystotome Cannulas



Knolle-Kelmann
30-10380-01
22 gauge



Nevyas
30-10380-02
22 gauge



Kratz
30-10380-03
22 gauge

Lens Manipulation Cannulas



Freeman
30-10384-01
27 gauge

Irrigating Vectis Cannulas



Cortex Aspiration Cannulas



Capsule Polishing Cannulas



Lachrymal Cannulas



30-10400-01
25 gauge



30-10400-02
25 gauge



30-10400-03
25 gauge



30-10400-04
25 gauge



Bonn
30-10400-05
19 gauge



Bangerter
30-10400-06 40 mm
30-10401-06 60 mm



Anel
30-10400-07
23 gauge



Anel
30-10400-08
23 gauge

Alpha-Chymotrypsin Cannula



30-10404-00
23 gauge

Air Injection Cannula



Sauter
30-10406-00
27 gauge

Collar Button Cannulas



Graether

Straight
30-10408-01

Angled
30-10408-02

Knife Cannula



Sato
30-10408-03
23 gauge

A/C Puncture Cannula



Schreck
30-10408-04
21 gauge



Castroviejo
30-10412-15



Castroviejo
30-10412-20
20 mm



Holth
30-10416-01



Haitz
30-10416-02



West
30-10420-16
16 cm/6¼"



West
30-10422-16
16 cm/6¼"



Connin-Amsler
30-10426-13
13 cm/5"



Wildier
30-10430-01



Wildier
30-10430-02



Wildier
30-10430-03



Castroviejo
30-010434-12



Muldoon
30-10438-10



Simpson
30-10442-01



Harms
30-10446-01



30-10446-02

Bowman
Fig.

0000/0000	30-10450-04
000/000	30-10450-03
00/00	30-10450-02
0/0	30-10450-01
1/1	30-10450-11
2/2	30-10450-22
3/3	30-10450-33
4/4	30-10450-44
5/5	30-10450-55
6/6	30-10450-66
7/7	30-10450-77
8/8	30-10450-88



Bowman
Fig.

0000/000	30-10452-03
000/00	30-10452-02
00/0	30-10452-00
0/1	30-10452-01
1/2	30-10452-12
2/3	30-10452-23
3/4	30-10452-34
4/5	30-10452-45
5/6	30-10452-56
6/7	30-10452-67
7/8	30-10452-78



Bowman
Fig.

0000/000	30-10454-03
000/00	30-10454-02
00/0	30-10454-00
0/1	30-10454-01
1/2	30-10454-12
2/3	30-10454-23
3/4	30-10454-34
4/5	30-10454-45
5/6	30-10454-56
6/7	30-10454-67
7/8	30-10454-78



Martial: NS German Silver



Castroviejo

Castroviejo
Width of Spatula

	mm
30-10458-05	0.50
30-10458-07	0.75
30-10458-10	1.00



Castroviejo
30-10462-12



Wheeler
30-10466-12



Lindner
30-10470-13



Smith-Fisher
30-10474-12



Green
30-10478-12



Dix
30-10482-01



Dix
30-10482-02



Stille
30-10486-01



Stille
30-10486-02



30-10490-12



Needle Only
30-10498-01

Chisel Only
30-10498-02

Gouge Only
30-10498-03

30-10494-13 30-10495-13



30-10500-13

Instrumentation for D. B. Kirby Operations



30-10502-10



Teeth
30-10506-10 1:2 Teeth
30-10508-10 2:3 Teeth



30-10510-10
1:2



Kirby
30-10514-10
10 cm/4"



Kirby
30-10516-10
10 cm/4"



30-10518-10



30-10520-10

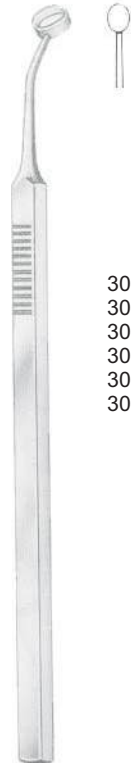

- 30-10524-01 =3.0 x 3.5 mm
- 30-10524-02 =3.0 x 4.0 mm
- 30-10524-03 =3.0 x 4.5 mm
- 30-10524-04 =3.5 x 4.0 mm
- 30-10524-05 =3.5 x 4.5 mm
- 30-10524-06 =3.5 x 5.0 mm

Bores



- 30-10528-01 =2.75 mm
- 30-10528-02 =3.00 mm
- 30-10528-03 =3.25 mm
- 30-10528-04 =3.75 mm
- 30-10528-05 =4.00 mm
- 30-10528-06 =4.25 mm
- 30-10528-07 =4.50 mm
- 30-10528-08 =4.75 mm
- 30-10528-09 =5.00 mm
- 30-10528-10 =6.00 mm
- 30-10528-11 =8.00 mm

Bores

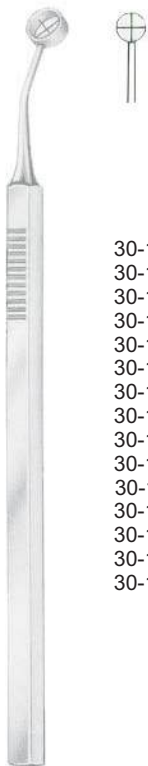

- 30-10532-01 =3.00 mm
- 30-10532-02 =3.25 mm
- 30-10532-03 =3.50 mm
- 30-10532-04 =3.75 mm
- 30-10532-05 =4.00 mm
- 30-10532-06 =4.25 mm
- 30-10532-07 =4.50 mm
- 30-10532-08 =4.75 mm
- 30-10532-09 =5.00 mm
- 30-10532-10 =5.50 mm
- 30-10532-11 =6.00 mm
- 30-10532-12 =7.00 mm
- 30-10532-13 =8.00 mm
- 30-10532-14 =9.00 mm
- 30-10532-15 =1.11 mm

Hoffer



- 30-10536-00
3 - 5 mm

Hoffer

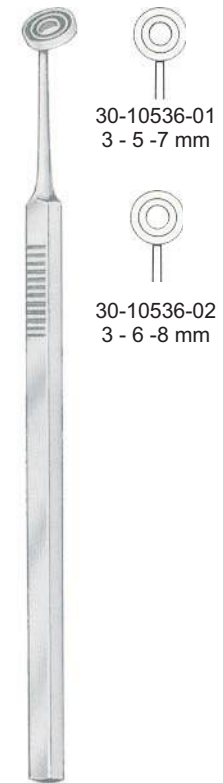

- 30-10536-01
3 - 5 - 7 mm

- 30-10536-02
3 - 6 - 8 mm

Hoffer



Tuebingen
30-10540-10
10 cm/4"



Tuebingen
30-10544-08
8.5 cm/3½"



Paufigue
30-10548-10
10 cm/4"



Barraquer
30-10552-10
10.5 cm/4¼"



McPherson
30-10556-10
10 cm/4"



McPherson
30-10560-07
7.5 cm/3"



McCullough
30-10564-09
9.5 cm/3 3/4"



McCullough
30-10568-09
9.5 cm/3 3/4"



Bonaccoito
30-10572-10
10 cm/4"



Bonaccoito
30-10576-10
10 cm/4"



30-10580-11
11 cm/4 1/2"



11 cm/4 1/2"

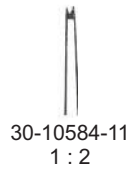

30-10584-11
1 : 2



30-10586-11
2 : 3



Nugent
10 cm/4"



30-10590-01



30-10590-02

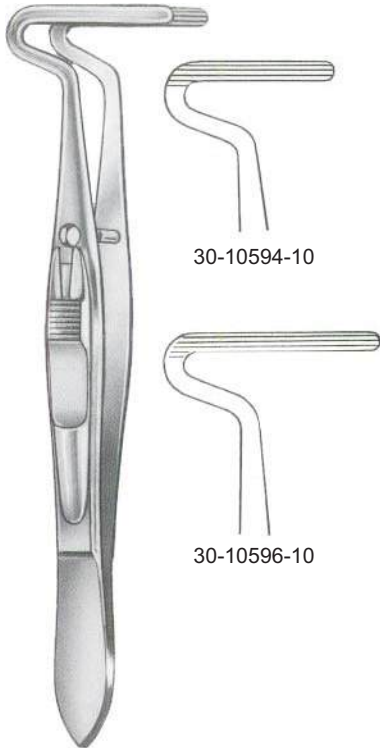

Berke
10 cm/4"



Blascovics
30-10600-09
9 cm/3½"



Blascovics
30-10601-09
9 cm/3½"



Worth
30-10604-10
10 cm/4"

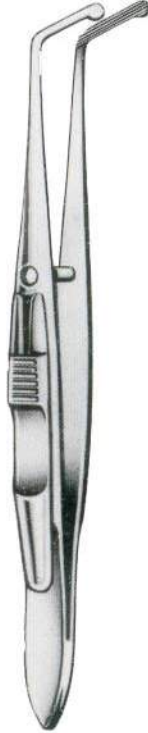

Worth
30-10605-10
10 cm/4"



Jameson
30-10608-10
10 cm/4"



Jameson
30-10609-10
10 cm/4"



Prince
30-10612-10
10 cm/4"



Prince
30-10613-10
10 cm/4"

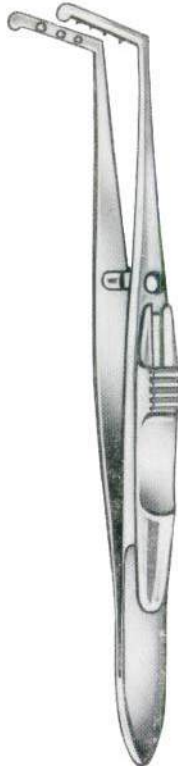

Sattler
30-10616-10
10 cm/4"

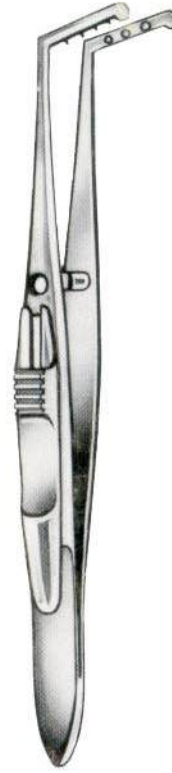

Sattler
30-10617-10
10 cm/4"



Snellen
30-10620-10
10 cm/4"



Snellen
30-10621-10
10 cm/4"



Erhardt
30-10624-09
9 cm/3 1/2"

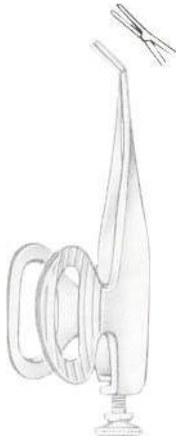

Barraquer
30-10628-05
5.5 cm/2¼"



Barraquer
30-10628-07
5.5 cm/2¼"



Barraquer
30-10628-10
5.5 cm/2¼"



Hess
30-10632-09
9 cm/3½"

◀Swiss patterns▶



Hess
30-10634-09
9 cm/3½"

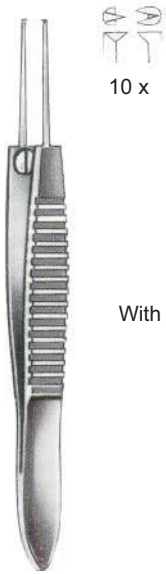

10 x

With guide pin

1:2
Bonn
30-10638-07
7 cm/2¾"



10 x

Without guide pin

1:2
Bonn
30-10640-07
7 cm/2¾"

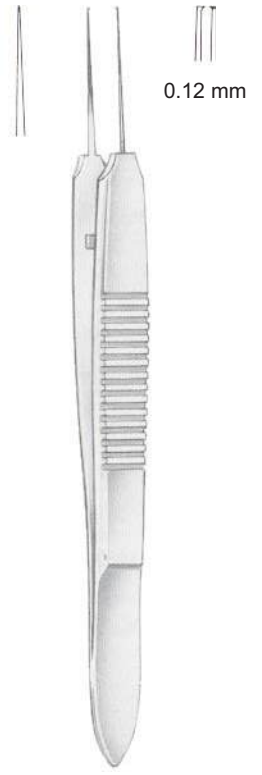

0.12 mm

Bonn
30-10642-10
10 cm/4"



Bishop-Harman
30-10646-08
8.5 cm/3½"



Bishop-Harman
30-10648-08
8.5 cm/3½"



Bishop-Harman
30-10650-08
8.5 cm/3½"



1:2
Bishop-Harman
30-10652-08
8.5 cm/3½"



Graefe
30-10656-05 0.5 mm
30-10656-07 0.7 mm
30-10656-10 1.0 mm
7 cm/2¾"



Graefe
30-10657-05 0.5 mm
30-10657-07 0.7 mm
30-10657-10 1.0 mm
7 cm/2¾"



1:2 Graefe
30-10660-05 0.5 mm
30-10660-07 0.7 mm
30-10660-10 1.0 mm
7 cm/2¾"



1:2 Graefe
30-10661-05 0.5 mm
30-10661-07 0.7 mm
30-10661-10 1.0 mm
7 cm/2¾"



Foerster
30-10664-08
8.5 cm/3½"



Foerster
30-10665-08
8.5 cm/3½"



Foerster
30-10668-08
8.5 cm/3½"



Foerster
30-10669-08
8.5 cm/3½"



Graefe
10 cm/4"



30-10672-10



30-10673-10



30-10675-10



30-10678-10



30-10679-10



30-10681-10

Conjunctival forceps



Stevens
10.5 cm/4 1/4"



30-10684-10



30-10685-10



30-10687-10

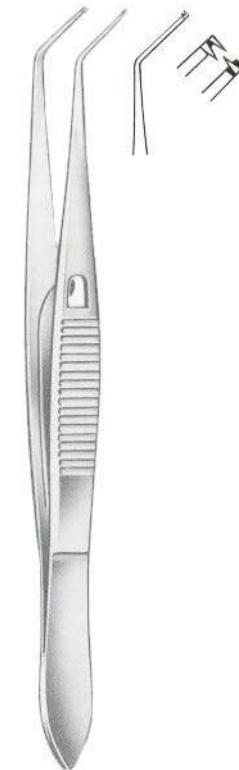

O'Connor
30-10696-10
10 cm/4"



30-10690-10



30-10691-10



30-10693-10



Stevens
30-10700-11
11 cm/4 1/2"



Stevens
30-10701-11
11 cm/4 1/2"



Fischer
30-10705-07
7 cm/2¾"



Fischer-Arit
30-10707-07
7 cm/2¾"



Hess
30-10711-07
7 cm/2¾"



Hess
30-10713-07
7 cm/2¾"



Smooth **Chandler** Serrated
30-10717-01 7 cm/2¾" 30-10717-02



Fuchs
30-10721-07
7 cm/2¾"



Gill-Hess
30-10723-07
7.5 cm/3"



Gill-Hess Teeth Below
30-10727-07 7.5 cm/3"
30-10729-07 Teeth on side



Barraquer-Katzin
(Colibri)
30-10733-07
7 cm/2¾"



10 x

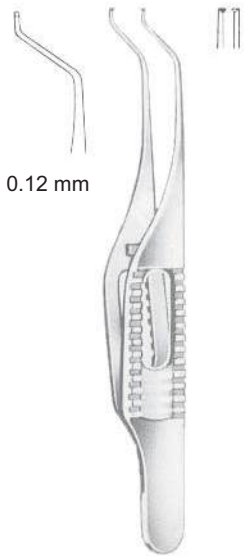

0.12 mm

Troutman (Colibri)
30-10737-07
7.5 cm/3"

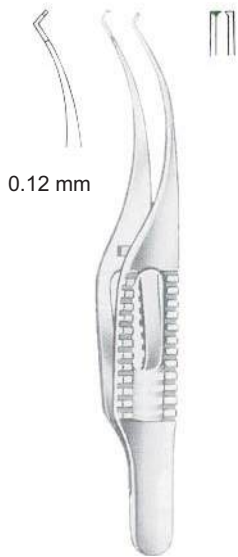

0.12 mm

Barraquer (Colibri)
30-10739-07
7 cm/2¾"

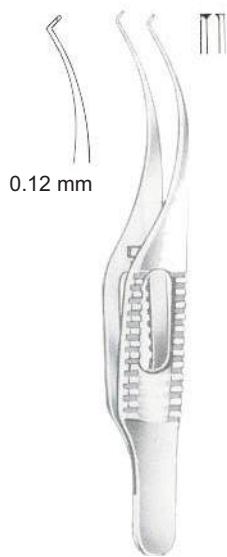

0.12 mm

Barraquer-Katzin (Colibri)
30-10741-07
7 cm/2¾"

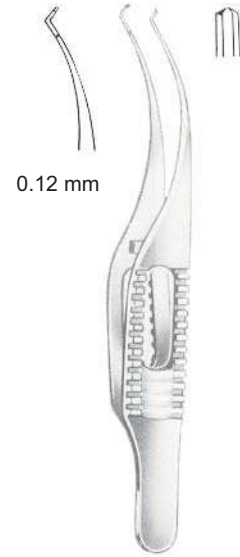

0.12 mm

Barraquer (Colibri)
30-10743-07
7 cm/2¾"



Gill-Arruga
30-10745-07
7.5 cm/3"



Terson
30-10749-09
9 cm/3½"



Schweigger
30-10753-10
10 cm/4"



Schweigger
30-10755-10
10 cm/4"



Elschnig
30-10759-10
10 cm/4"



Hess
30-10763-06
6 cm/2¼"



Hess
30-10765-06
6.5 cm/2½"



Fuchs
30-10771-07
7 cm/2¾"



Kalt
30-10775-10
10 cm/4"



Terson
30-10779-09
9.5 cm/3¾"



Arruga-Nizetic
30-10783-10
10 cm/4"



Castroviejo
30-10787-10
10 cm/4"



Castroviejo
30-10789-10
10 cm/4"



Elschnig
30-10793-10
10 cm/4"

For Len Implantation



Binkhorst
30-10797-07
7 cm/2¾"



Arruga
30-10801-09
9.5 cm/3¾"



Arruga
30-10803-09
9.5 cm/3¾"



With irrigator
30-10807-01

Without irrigator
30-10807-02

Shepard



Dastoor
30-10811-06
6 cm/2 1/4"



Arruga
30-10815-10
10 cm/4"

Calibrated
Arruga
30-10817-10
10 cm/4"



Arruga
30-10819-10
10 cm/4"

Calibrated
Arruga-Elschnig
30-10821-10
10 cm/4"



Knapp
30-10824-11
11 cm/4¼"



Ayer
30-10828-09
9 cm/3½"



Ayer
30-10830-09
9 cm/3½"



Lambert
30-10834-09
9 cm/3½"



Desmarres
9 cm/3½"



30-10838-01



30-10838-02



30-10838-03

Corneal Fixation Forceps

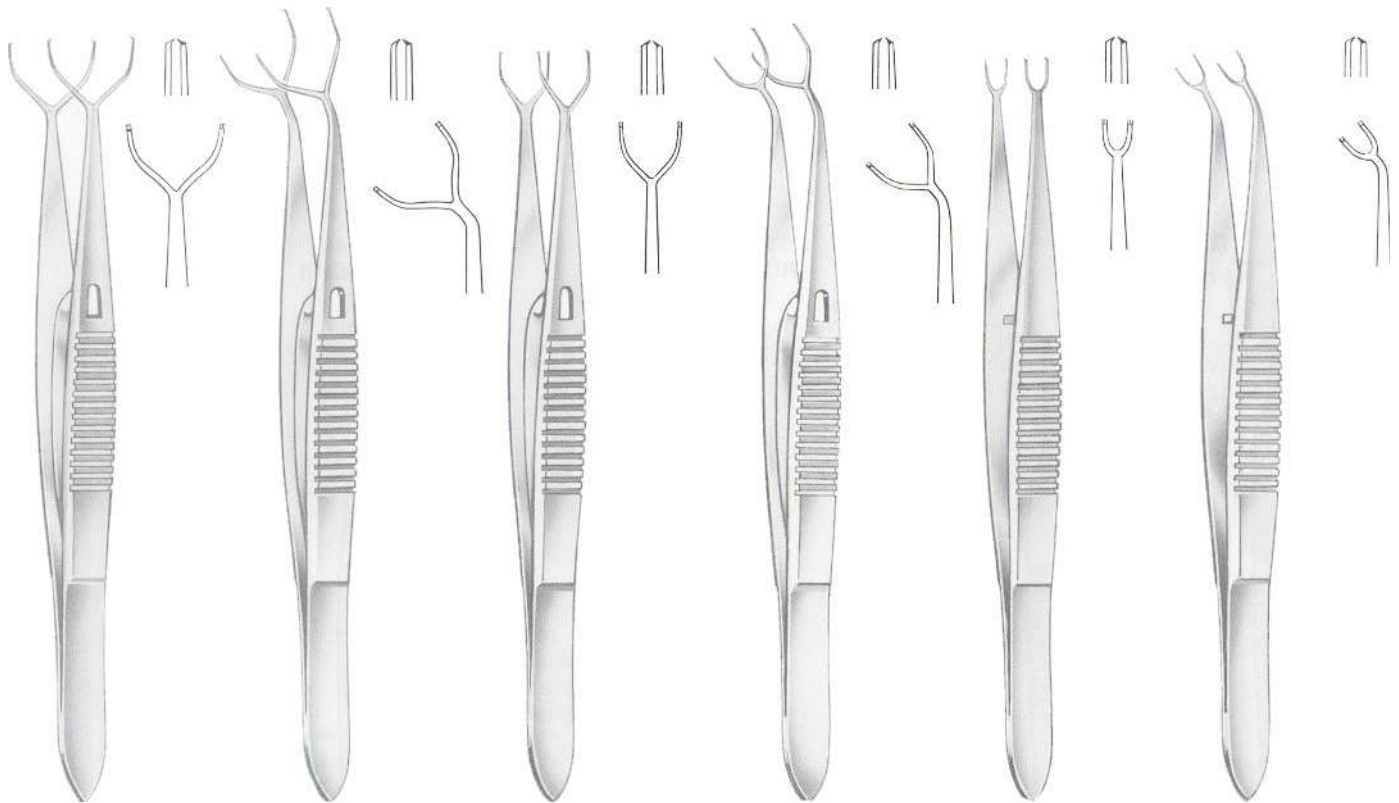

Kremer
30-10842-10
10 cm/4"
0.12 mm

Kremer
30-10843-10
10 cm/4"
0.12 mm

Arrowsmith
30-10848-10
10 cm/4"
0.12 mm

Arrowsmith
30-10849-10
10 cm/4"
0.12 mm

Bores
30-10852-10
10 cm/4"
0.12 mm

Rubman-Bores
30-10853-10
10 cm/4"
0.12 mm



Without Spring Catch
30-10858-11

With Spring Catch
30-10860-11

Graefe
11 cm/4½"



2 : 3 Teeth

30-10864-11
11 cm/4½"



3 : 4 Teeth

30-10866-11
11 cm/4½"



Castroviejo
30-10870-09
9 cm/3½"



Castroviejo
30-10872-09
9 cm/3½"



Moorfield
30-10876-10
10 cm/4"



Lester
30-10880-02 1 : 2
30-10882-03 2 : 3
9 cm/3½"



Castroviejo
10 cm/4"

Straight
30-10886-01
30-10886-02
30-10886-03
30-10886-04
30-10886-05

Width of Teeth
0.12 mm
0.30 mm
0.50 mm
1.00 mm
1.05 mm

Curved
30-10887-01
30-10887-02
30-10887-03
30-10887-04
30-10887-05



Castroviejo
10 cm/4"



Castroviejo
30-10890-09
9 cm/3½"



St. Martin
30-10894-07
7 cm/2¾"



Elschnig
30-10898-11
11.5 cm/4½"



Elschnig
30-10900-11
11.5 cm/4½"



Barraquer
30-10904-10
10 cm/4"



Green
10 cm/4"

Wide
05 mm
10 mm

Without Spring Catch
30-10908-05
30-10908-10

Wide
05 mm
10 mm

With Spring Catch
30-10910-05
30-10910-10



30-10913-12
12 cm/4¾"



30-10914-12
12 cm/4¾"



Woodruff
30-10918-13
13 cm/5"



Woodruff
30-10920-13
13 cm/5"



Jacobi
30-10924-14
14 cm/5½"

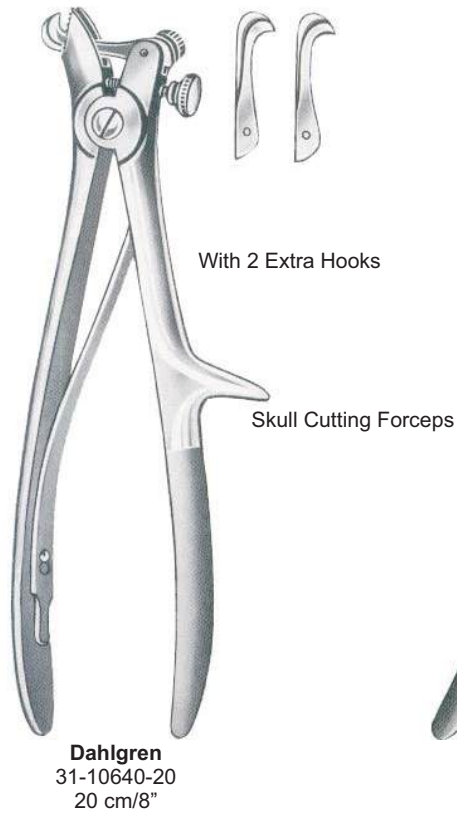

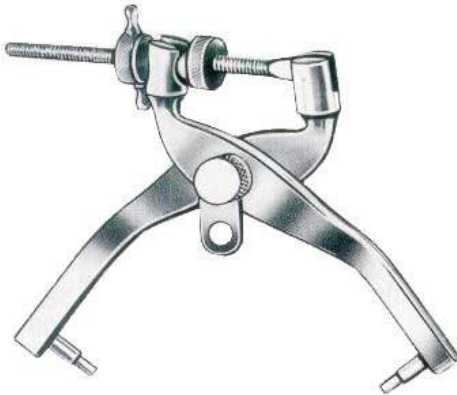

Crutchfield
31-10948-00



Crutchfield
31-10952-00



31-10956-00



Crutchfield
31-10960-00
Complete With 2 Drills

Applying and Removing Forceps



Raney
31-10964-00
16 cm/6¼"

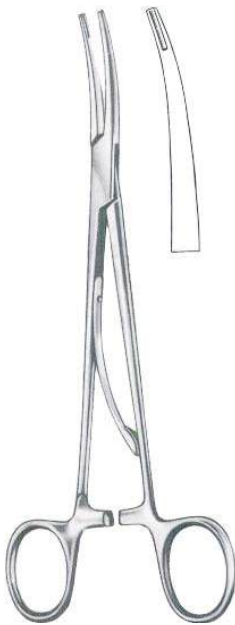

McKenzie
31-10968-15 15 cm/6"
31-10968-19 19 cm/7½"



Olivecrona-Tonnis
31-10972-14

Medial



- mm
31-10976-40 40 x 20
31-10976-45 45 x 20
31-10976-50 50 x 20
31-10976-55 55 x 20
31-10976-60 60 x 20

Lateral



- mm
31-10978-40 40 x 20
31-10978-45 45 x 20
31-10978-50 50 x 20
31-10978-55 55 x 20
31-10978-60 60 x 20



- mm
31-10980-40 40 x 20
31-10980-45 45 x 20
31-10980-50 50 x 20
31-10980-55 55 x 20
31-10980-60 60 x 20



- Blunt Blades, For Taking
mm
31-10982-50 50 x 25
31-10982-50 60 x 25

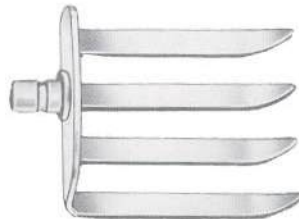

- mm
31-10984-35 35 x 52
31-10984-40 40 x 52
31-10984-45 45 x 52
31-10984-50 50 x 52
31-10984-55 55 x 52
31-10984-60 60 x 52
31-10984-65 65 x 52
31-10984-70 70 x 52



- mm
31-10986-35 35 x 37
31-10986-40 40 x 37
31-10986-45 45 x 37
31-10986-50 50 x 37
31-10986-55 55 x 37
31-10986-60 60 x 37
31-10986-60 65 x 37
31-10986-60 70 x 37



- mm
31-10988-35 35 x 22
31-10988-40 40 x 22
31-10988-45 45 x 22
31-10988-50 50 x 22
31-10988-55 55 x 22
31-10988-60 60 x 22
31-10988-65 65 x 22
31-10988-70 70 x 22



- mm
31-10990-50 50

Hook



- mm
31-10992-70 70

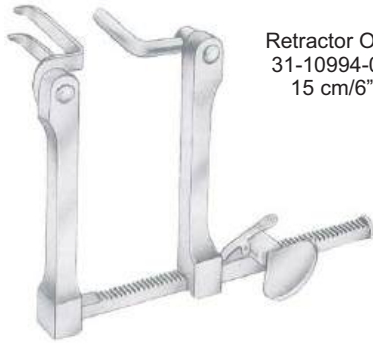

Retractor Only
31-10994-01
15 cm/6"

Caspar
31-10994-00

Retractor Complete With
1 Blade Each
31-10988-40
31-10990-50



Retractor Only
31-10998-01
12 cm/4 3/4"

Caspar
31-10998-00

Retractor Complete With
1 Blade Each
31-10976-40
31-10978-40

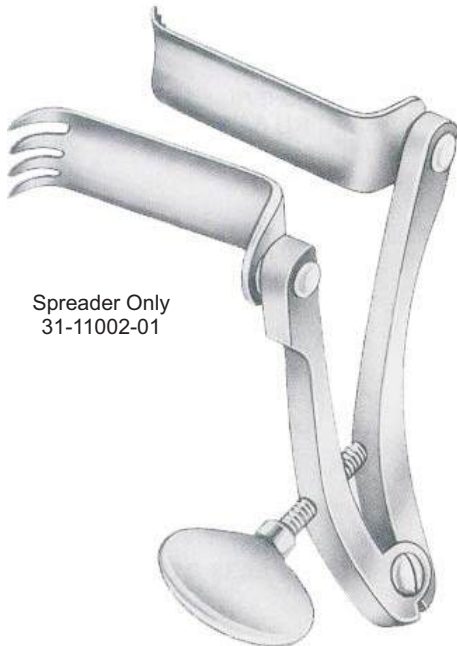

Spreader Only
31-11002-01

Caspar
31-11002-00
Retractors Only
Spreader Complete With
1 Blade Each
31-11976-45
31-11976-60

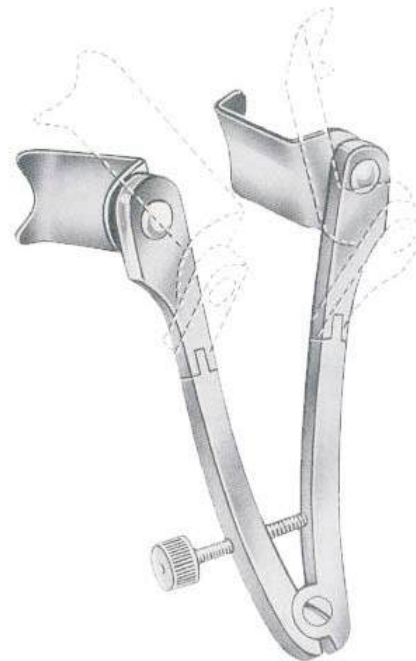

Spreader Only
31-11006-01

Caspar
31-11006-00
Spreader Only
Retractor Complete With
1 Blade Each
31-11980-40
31-11980-40

31-11010-01
15 cm/6"
Retractor only

Caspar
31-11010-00
31-10980-45
31-10980-65
Retractor complete with
1 blade each



31-11014-01
15 cm/6"
Retractor only

Caspar
31-11014-00
31-10980-45
31-10980-65
Retractor adjustable, con
1 blade each

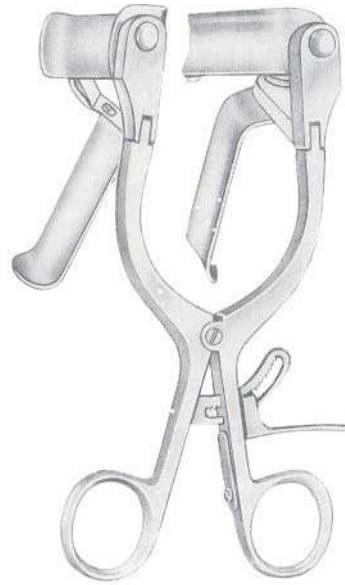

31-11018-01
Retractor only
with 1 fixed blade

Caspar
31-11018-00
Retractor complete,
with 5 blades

31-11018-40
40 mm



31-11018-45
45 mm



31-11018-50
50 mm



31-11018-55
55 mm



31-11018-60
60 mm





31-11022-01
Retractor only

Cloward
31-11022-00
25 cm/10"
complete with 5 blades

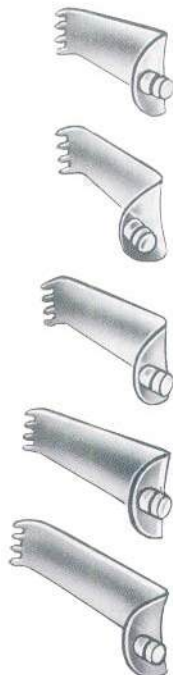

31-11022-40
15x40 mm

31-11022-45
15x45 mm

31-11022-50
15x50 mm

31-11022-55
15x55 mm

31-11022-60
15x60 mm



31-11026-01
Retractor only

Cloward
31-11026-00
15 cm/6"
complete with 5 blades

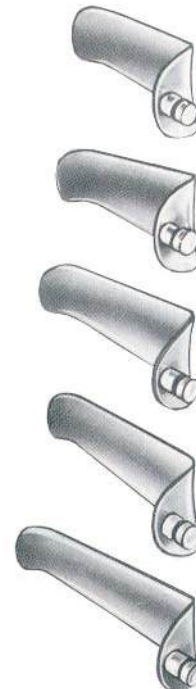

31-11026-40
15x40 mm

31-11026-45
15x45 mm

31-11026-50
15x50 mm

31-11026-55
15x55 mm

31-11026-60
15x60 mm



Inge
31-11030-16
16 cm/6 $\frac{1}{4}$ "



Inge
31-11032-27
27 cm/10 $\frac{3}{4}$ "



Cloward
31-11036-15
15 cm/6"



Cloward
31-11040-16
16 cm/6 $\frac{1}{4}$ "

Muscle blades



Frame
31-11044-01

Hey
31-11044-00
31-11046-00
23 cm/9"



31-11044-50
20x50 mm



31-11044-60
20x60 mm



31-11044-70
20x70 mm

Vertebra-pins

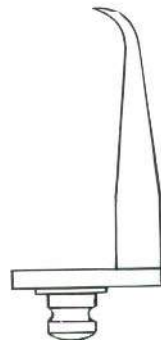

31-11046-50
50 mm



31-11046-60
60 mm



31-11046-70
70 mm



	Left-type	Right-type
50x10 mm	31-11050-01	31-11052-01
60x10 mm	31-11050-02	31-11052-02
70x10 mm	31-11050-03	31-11052-03
50x20 mm	31-11054-01	31-11056-01
60x20 mm	31-11054-02	31-11056-02
70x20 mm	31-11054-03	31-11056-03

Toothed

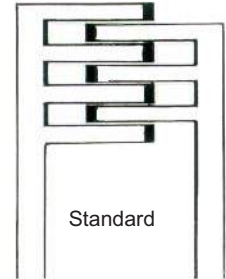

31-11060-00 Complete 31-11062-00
14.5 cm/5¾" Consisting of 17 cm/6¾"

31-11060-01 Frame 31-11062-01
31-11060-21 Centre Blades 31-11060-21
31-11060-22 31-11060-22
31-11060-23 31-11060-23



Henly

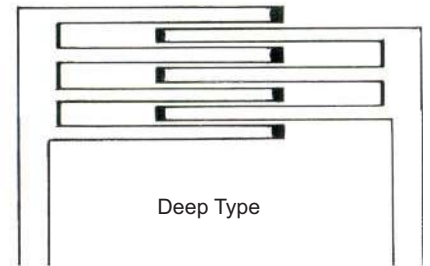

31-11064-00 Complete 31-11066-00
14.5 cm/5¾" Consisting of 17 cm/6¾"

31-11060-01 Centre Blades 31-11066-01
31-11060-21 31-11060-21
31-11060-22 31-11060-22
31-11060-23 31-11060-23



Davis
31-11070-24
24.5 cm/9 3/4"



Toennis
31-11074-25
25 cm/10"



Frazier
31-11078-15



Hoen
31-11080-15



Hoen
31-11082-15

15 cm/6"



Love-Adson
31-11086-16
16 cm/6 1/2"

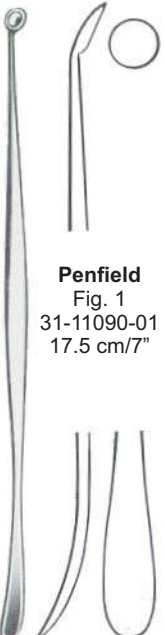

Penfield
Fig. 1
31-11090-01
17.5 cm/7"



Penfield
Fig. 2
31-11090-02
19.5 cm/7 3/4"

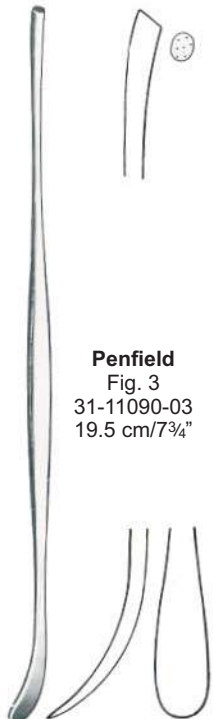

Penfield
Fig. 3
31-11090-03
19.5 cm/7 3/4"



Penfield
Fig. 4
31-11090-04
21.5 cm/8 1/2"



Penfield
Fig. 5
31-11090-05
29 cm/11 1/2"



Sachs
31-11094-21
21 cm/8¼"

Sharp

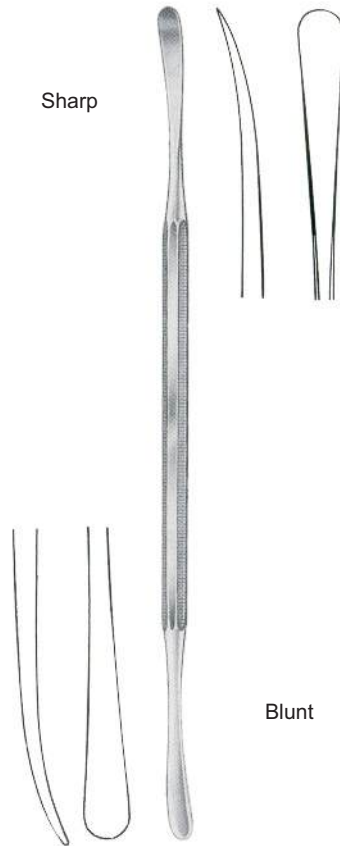

Blunt

31-11098-22
22 cm/8¼"



Woodsen
31-11102-25
25 cm/10"



Fragner
31-11106-20
20 cm/8"



Fragner
31-11108-20
20 cm/8"



Sachs
31-11112-21
21 cm/8¼"

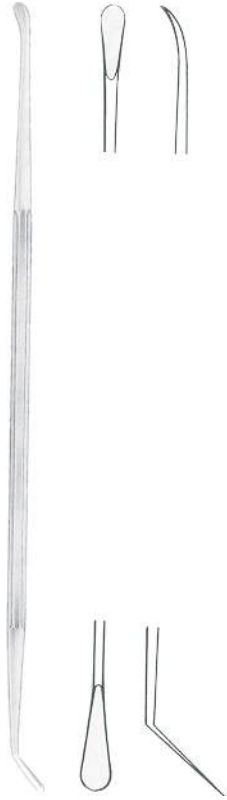

Milligan
31-11116-21 21 cm/8¼"



Olivecrona
31-11120-18 18 cm/7"
31-11120-24 24 cm/9½"



Olivecrona
31-11124-19 19.5 cm/7¾"
31-11124-24 24 cm/9½"



Horsley
31-11128-20 20 cm/8"



Sachs
31-11132-21 21 cm/8¼"



Cushing
17 cm/6¾"
20 cm/8"
28 cm/11"

31-11136-17
31-11136-20
31-11136-28



Olivecrona
18 cm/7"
Width of Spatulas

	Upper end		Lower end		
	Concave	mm	mm	Convex	
31-11140-01		7	9		31-11142-01
31-11140-02		11	13		31-11142-02
31-11140-03		15	18		31-11142-03
31-11140-04		18	22		31-11142-04



Heifetz
20 cm/8"

Width of Spatulas

Upper end		Lower end	
mm		mm	
7	31-11144-08	8	
10	31-11144-11	11	
13	31-11144-14	14	
16	31-11144-17	17	
19	31-11144-20	20	
22	31-11144-25	22	



Heifetz
15.5 cm/6"

Width of Spatulas

31-11148-08	8
31-11148-11	11
31-11148-14	14
31-11148-17	17

Length of Spatulas



18 cm/7"

Width of spatulas

Upper end		Lower end	
mm	mm		
7	9	31-11152-09	
11	13	31-11152-13	
15	18	31-11152-18	
18	22	31-11152-22	



20 cm/8"
12 mm 31-11156-12
17 mm 31-11156-17



20 cm/8"
14 mm 31-11160-14
17 mm 31-11160-17
20 mm 31-11160-20



31-11164-01
19cm/7½"



Love
31-11164-02
19 cm/7½"

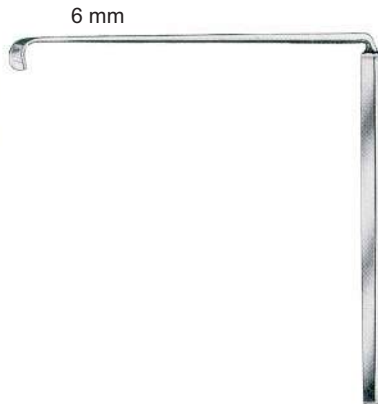

31-11164-03



Love
31-11168-21
21 cm/8¼"

Length of spatulas



70 mm
3 mm 31-11172-03

100 mm
31-11174-03



5 mm 31-11172-05

31-11174-05



7 mm 31-11172-07

31-11174-07



Love



Scoville
23 cm/9"

7 mm 31-11176-07
9 mm 31-11176-09



Holsher
7mm 31-11177-07
9mm 31-11177-09
24 cm/9½"



8 mm 31-11179-08
13 mm 31-11179-13



Taylor
30x 70 mm 31-11180-07 17 cm/6¾"
30x100 mm 31-11180-10 17 cm/6¾"



Oldberg
21 cm/8¼"



31-11182-01



31-11182-02



31-11182-03



31-11182-04



Cushing
31-11184-19 19 cm/7¾"
31-11184-28 28 cm/11"



Smithwick
31-11188-17 17 cm/6½"
31-11188-21 21 cm/8¼"



Cushnig
31-11190-14
14 cm/5½"



Adson
20 cm/8"



31-11192-01



31-11192-02



Cloward
31-11196-16
16 cm/6½"



Hoen
31-11200-22
22 cm/8¾"



Dandy
31-11204-01
20 cm/8"



Dandy
31-11204-02
20 cm/8"



Dandy
31-11204-03
20 cm/8"



Smithwick
31-11208-29
29 cm/11¾"



Scoville
31-11212-30
30 cm/12"



Scoville
31-11214-30
30 cm/12"



Graham
31-11218-16
16.5 cm/6½"



Toennis
31-11222-15
15 cm/6"



Frazier
31-11226-13 13 cm/5"
31-11226-18 18 cm/7"



Toennis
31-11230-13 13 cm/5"
31-11230-18 18 cm/7"





Olivecrona
31-11234-23
23 cm/9"



Olivecrona
31-11236-20
20.5 cm/8"





Ferris-Smith-Kerrison

		Width of Bite	Length of Shaft		
			15 cm/6"	20 cm/8"	18 cm/7"
Cutting Upward		0.6 mm			31-11252-00
		1 mm			31-11252-01
		2 mm			31-11252-02
		3 mm	31-11240-03	31-11246-03	31-11252-03
		4 mm			31-11252-04
		5 mm	31-11240-05	31-11246-05	31-11252-05
Cutting Upward 40°		0.6 mm			31-11254-00
		1 mm			31-11254-01
		2 mm			31-11254-02
		3 mm	31-11242-03	31-11248-03	31-11254-03
		4 mm			31-11254-04
		5 mm	31-11242-05	31-11248-05	31-11254-05
Cutting Downwards		0.6 mm			31-11256-00
		1 mm			31-11256-01
		2 mm			31-11256-02
		3 mm	31-11244-03	31-11250-03	31-11256-03
		4 mm			31-11256-04
		5 mm	31-11244-05	31-11250-05	31-11256-05







Ferris-Smith-Kerrison

		Width of Bite		Length of Shaft		
		3 mm	5 mm	15 cm/6"	20 cm/8"	18 cm/7"
Cutting Upward		3 mm	5 mm	31-11260-03 31-11260-05	31-11266-03 31-11266-05	31-11272-03 31-11272-05
Cutting Upward 40°		3 mm	5 mm	31-11262-03 31-11262-05	31-11268-03 31-11268-05	
Cutting Downward		3 mm	5 mm	31-11264-03 31-11264-05	31-11270-03 31-11270-05	31-11274-03 31-11274-05



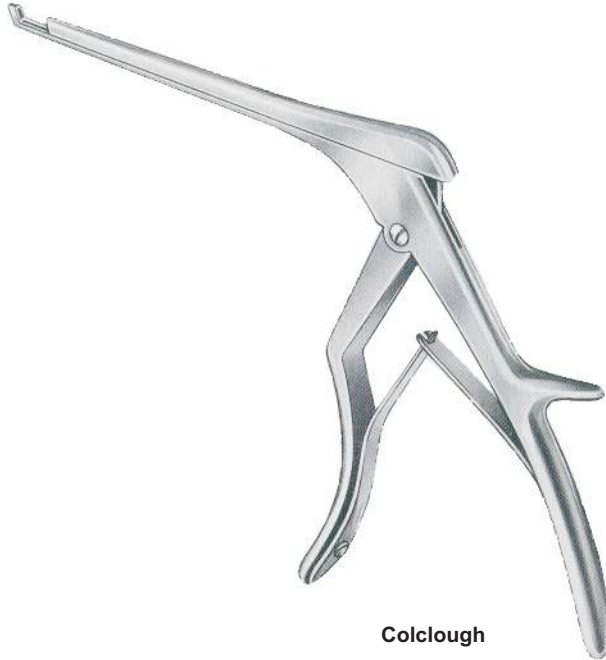

Love-Kerrison

		Width of Bite		Length of Shaft		
		2 mm	3 mm	15 cm/6"	20 cm/8"	18 cm/7"
Cutting Upward		2 mm				31-11286-02
		3 mm	31-11278-03	31-11282-03		31-11286-03
		4 mm	31-11278-04	31-11282-04		31-11286-04
		5 mm	31-11278-05	31-11282-05		31-11286-05
		6 mm				31-11286-06
Cutting Upward 40°		2 mm				31-11288-02
		3 mm				31-11288-03
		4 mm				31-11288-04
		5 mm				31-11288-05
		6 mm				31-11288-06
Cutting Downward		2 mm				31-11290-02
		3 mm	31-11280-03	31-11284-03		31-11290-03
		4 mm	31-11280-04	31-11284-04		31-11290-04
		5 mm	31-11280-05	31-11284-05		31-11290-05
		6 mm				31-11290-06
Cutting Upward 40°		2 mm				31-11292-02
		3 mm				31-11292-03
		4 mm				31-11292-04
		5 mm				31-11292-05
		6 mm				31-11292-06



Colclough

		Width of Bite	Length of Shaft	
			15 cm/6"	20 cm/8"
Cutting Upward		3 mm 5 mm	31-11296-03 31-11296-05	31-11302-03 31-11302-05
Cutting Upward 40°		3 mm 5 mm	31-11298-03 31-11298-05	31-11304-03 31-11304-05
Cutting Downward		3 mm 5 mm	31-11300-03 31-11300-05	31-11306-03 31-11306-05



	Length Of Shaft			
Cushing 2 x 10 cm	5"/13 cm	31-11310-01	31-11310-02	31-11310-03
	6"/15 cm	31-11312-01	31-11312-02	31-11312-03
	7"/18 cm	31-11314-01	31-11314-02	31-11314-03
Love-Grunwald 3 x 10 cm	5"/13 cm	31-11316-01	31-11316-02	31-11316-03
	6"/15 cm	31-11318-01	31-11318-02	31-11318-03
	7"/18 cm	31-11320-01	31-11320-02	31-11320-03
Spurling 4 x 10 cm	5"/13 cm	31-11322-01	31-11322-02	31-11322-03
	6"/15 cm	31-11324-01	31-11324-02	31-11324-03
	7"/18 cm	31-11326-01	31-11326-02	31-11326-03



	Length Of Shaft			
Cushing 2 x 10 cm	5"/13 cm	31-11330-01	31-11330-02	31-11330-03
	6"/15 cm	31-11332-01	31-11332-02	31-11332-03
	7"/18 cm	31-11334-01	31-11334-02	31-11334-03
Love-Grunwald 3 x 10 cm	5"/13 cm	31-11336-01	31-11336-02	31-11336-03
	6"/15 cm	31-11338-01	31-11338-02	31-11338-03
	7"/18 cm	31-11340-01	31-11340-02	31-11340-03
Spurling 4 x 10 cm	5"/13 cm	31-11342-01	31-11342-02	31-11342-03
	6"/15 cm	31-11344-01	31-11344-02	31-11344-03
	7"/18 cm	31-11346-01	31-11346-02	31-11346-03

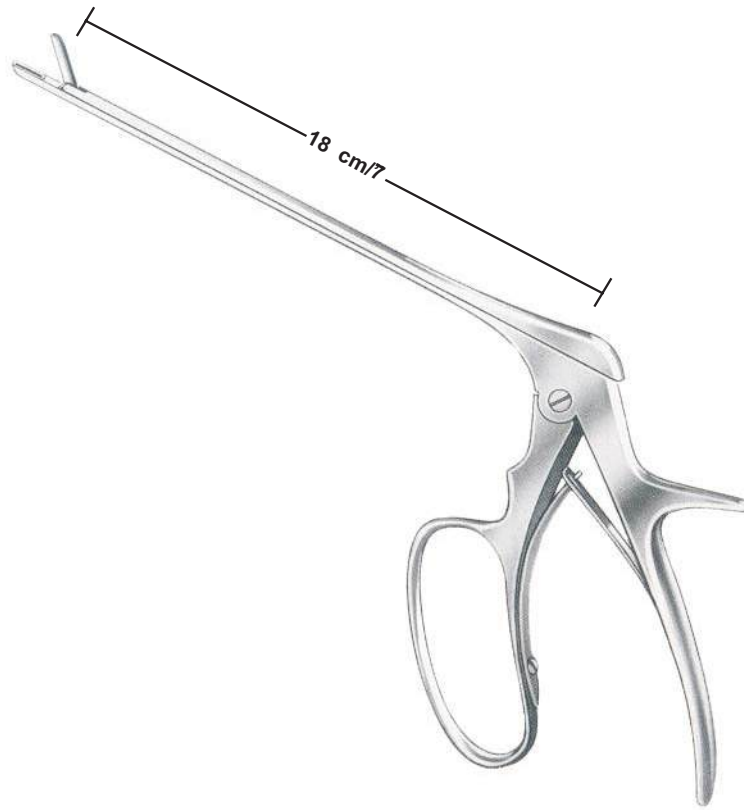

Ferris-Smith

Width Of Jaw



2 x 10 mm	31-11350-01	31-11350-02	31-11350-03
3 x 10 mm	31-11352-01	31-11352-02	31-11352-03
4 x 10 mm	31-11354-01	31-11354-02	31-11354-03

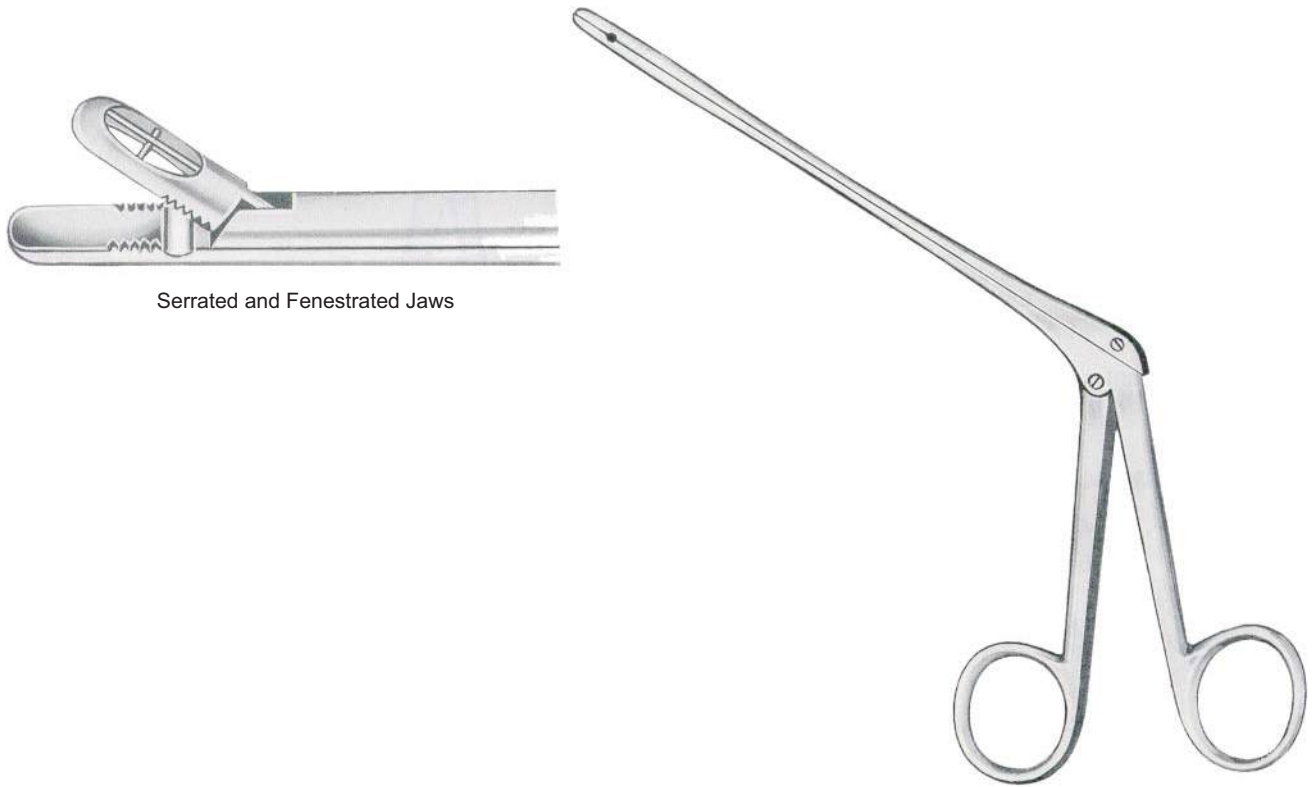

Serrated and Fenestrated Jaws

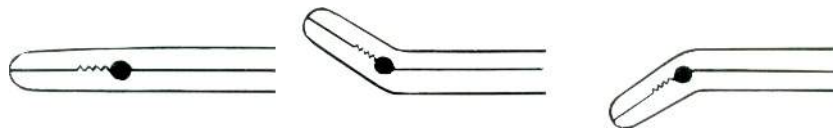

Width Of Jaw	Length Of Shaft			
mm	14 cm/5 1/2"	31-11358-01	31-11358-02	31-11358-03
	16 cm/6 1/4"	31-11360-01	31-11360-02	31-11360-03
2 x 12	14 cm/5 1/2"	31-11362-01	31-11362-02	31-11362-03
	16 cm/6 1/4"	31-11364-01	31-11364-02	31-11364-03
3 x 12	14 cm/5 1/2"	31-11366-01	31-11366-02	31-11366-03
	16 cm/6 1/4"	31-11368-01	31-11368-02	31-11368-03
4 x 14	14 cm/5 1/2"	31-11370-01	31-11370-02	31-11370-03
	16 cm/6 1/4"	31-11372-01	31-11372-02	31-11372-03
5 x 14	14 cm/5 1/2"	31-11374-01	31-11374-02	31-11374-03
	16 cm/6 1/4"	31-11376-01	31-11376-02	31-11376-03
6 x 16	14 cm/5 1/2"			
	16 cm/6 1/4"			

Serrated Jaws

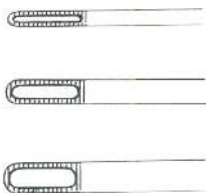

		mm	
31-11378-02	2 x 10	13 cm/5"	
31-11378-03	3 x 10	13 cm/5"	
31-11378-04	4 x 10	13 cm/5"	

Length Of Shaft

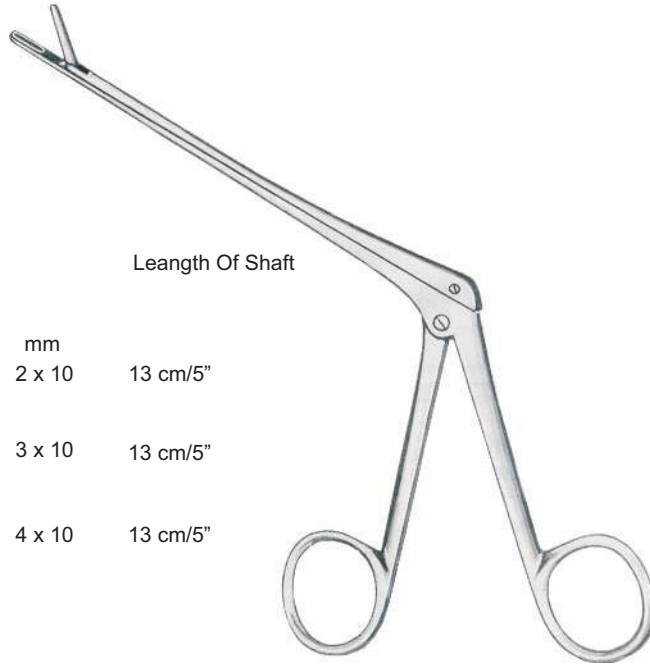

Schlessinger

Grasping Forceps

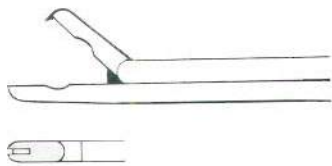

31-11382-16

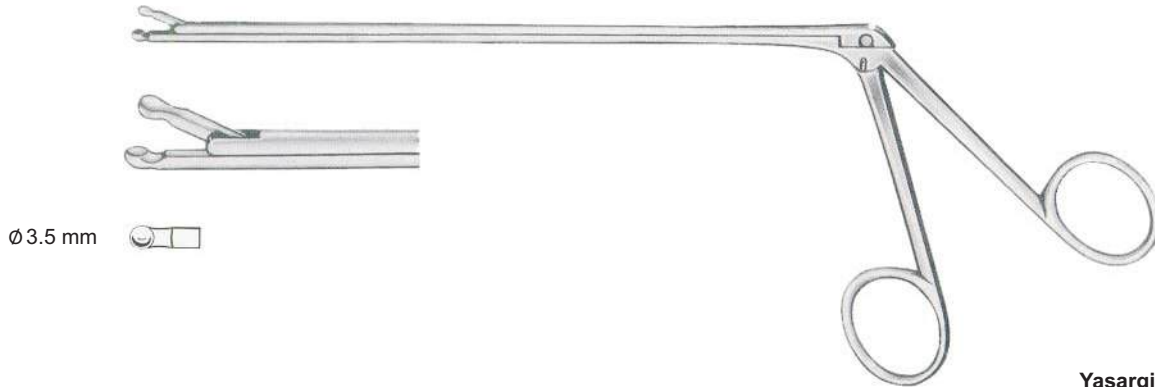

Ø 3.5 mm

Yasargil
31-11386-35
19.5 cm/7³/₄"

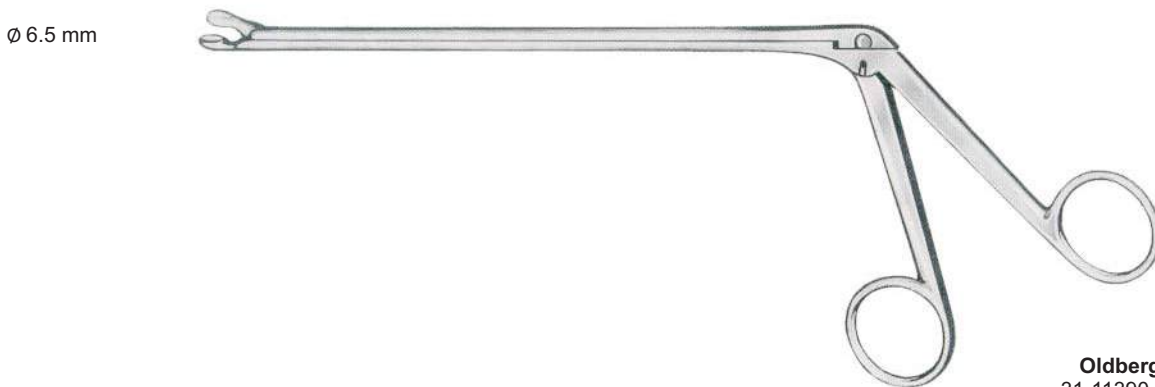

Ø 6.5 mm

Oldberg
31-11390-65
18 cm/7"

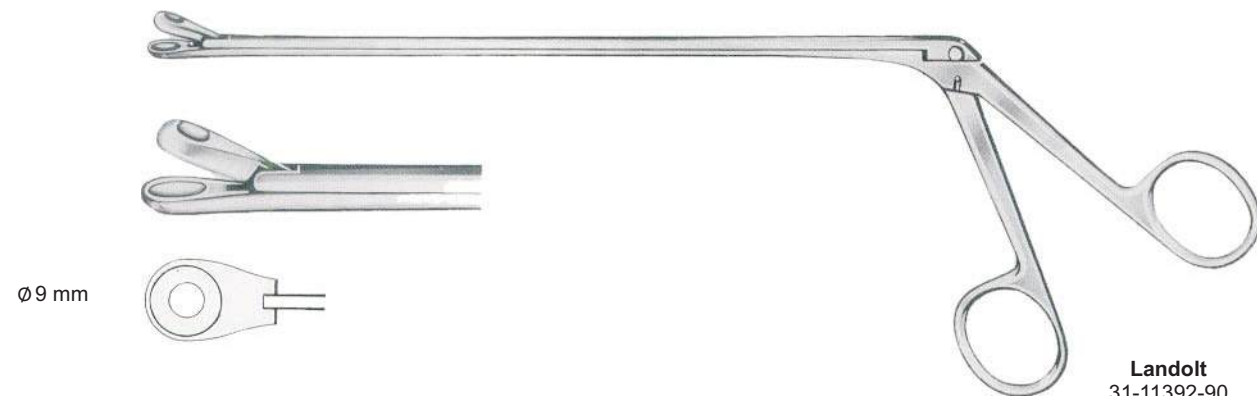

Ø 9 mm

Landolt
31-11392-90
21 cm/8¹/₄"

Tumor Grasping Forceps Blunt

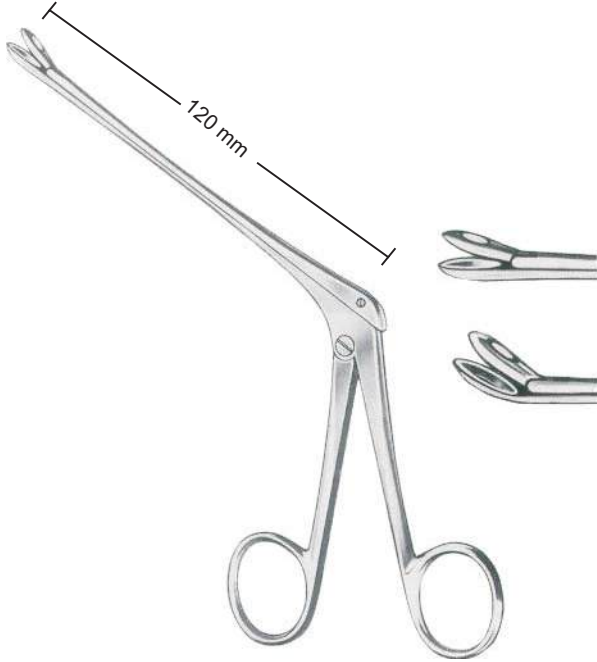

Weil-Blakesley



31-11396-01



31-11396-02



31-11396-03



31-11396-04



31-11396-05



31-11398-01



31-11398-02



31-11398-03



31-11398-04



31-11398-05



31-11402-01



31-11402-02



31-11402-03



31-11402-04



31-11402-05



31-11404-01



31-11404-02



31-11404-03



31-11404-04



31-11404-05

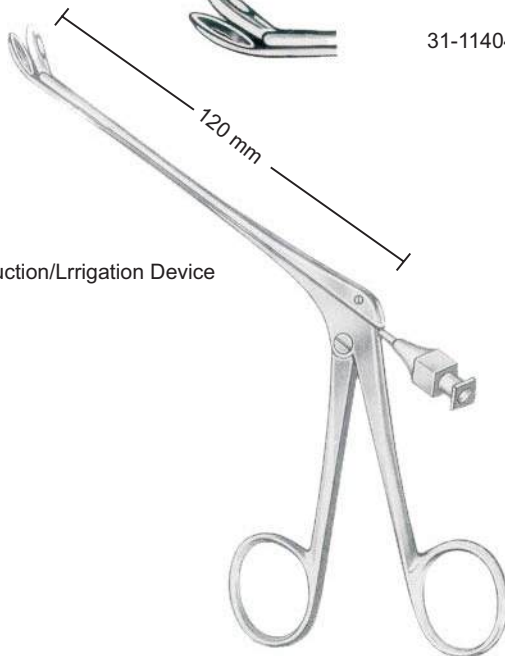

With Suction/Irrigation Device

Weil-Blakesley



31-11408-01
5 x 4 mm



31-11408-02
5 x 4 mm



31-11408-03
5 x 3.5 mm



31-11408-04
5 x 3.5 mm

Hajek
(Hajek-Kofler)
14 cm/5½"

360° Turnable

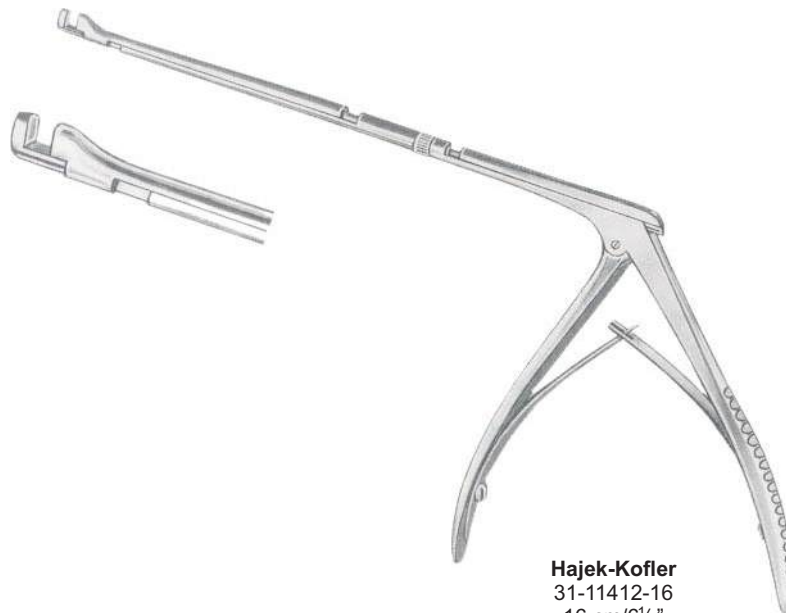

Hajek-Kofler
31-11412-16
16 cm/6½"

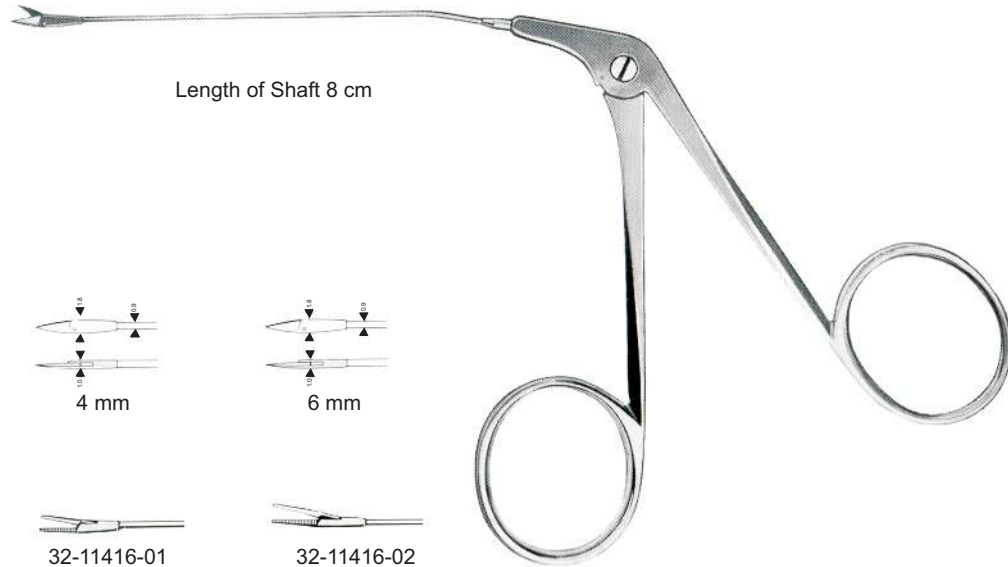

Micro Forceps

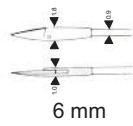
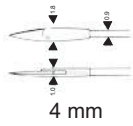

Straight



Angled Up



Straight



Oval Cup Jaws



Micro Scissors

Straight



Angled Up



Curved Right



Curved Left



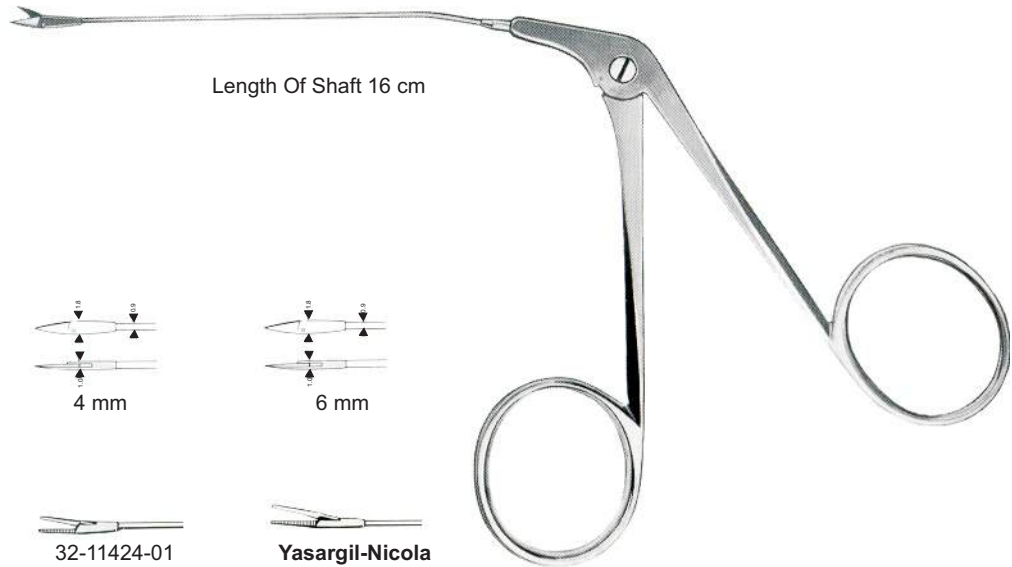

Micro Forceps

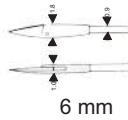
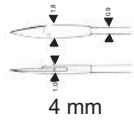

Straight



Angled Up



Cup-Shaped Forceps

Straight

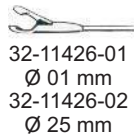

Oval Cup Jaws



Micro Forceps

Straight



Angled Up



Curved Right



Curved Left



Micro Scissors

Length of Shaft 14 cm

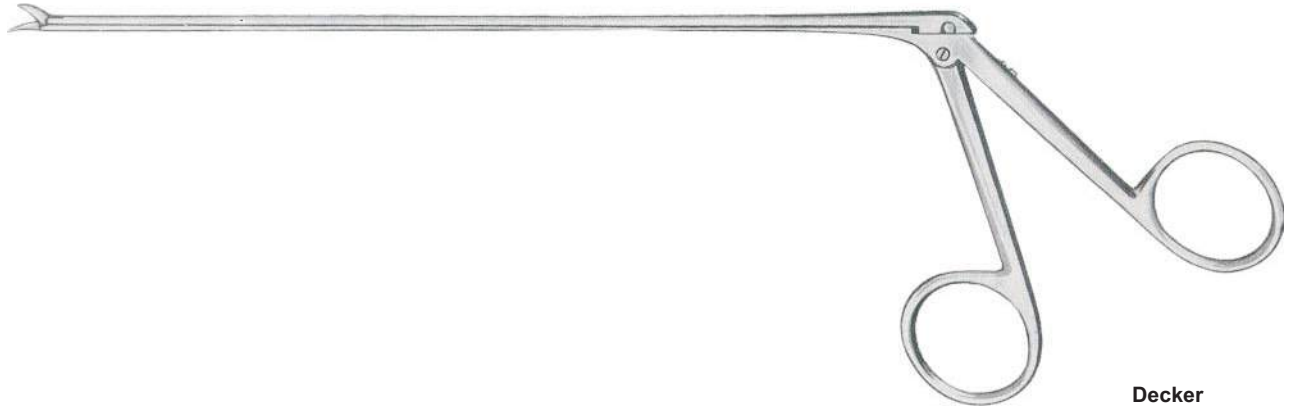

Straight
32-11430-01



Curved Right
32-11430-02



Curved Left
32-11430-03



Jacobson
32-11432-00
18.5 cm/7¼"



Koos
32-11432-01
18.5 cm/7¼"



Koos
32-11432-02
18.5 cm/7¼"

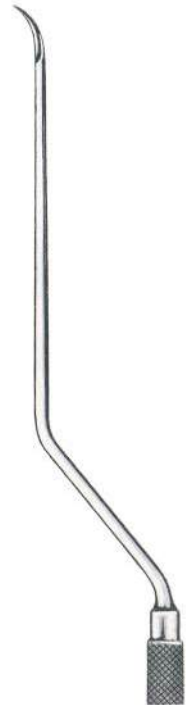

Koos
32-11432-03
18.5 cm/7¼"



Koos
32-11432-04
18.5 cm/7¼"



Koos
32-11434-01
18.5 cm/7¼"



Koos
32-11434-02
18.5 cm/7¼"



Yasargil
32-11434-03
18.5 cm/7¼"

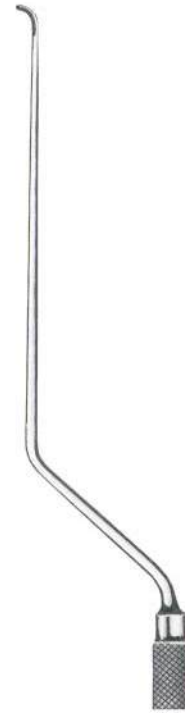

Yasargil
32-11434-04
18.5 cm/7¼"

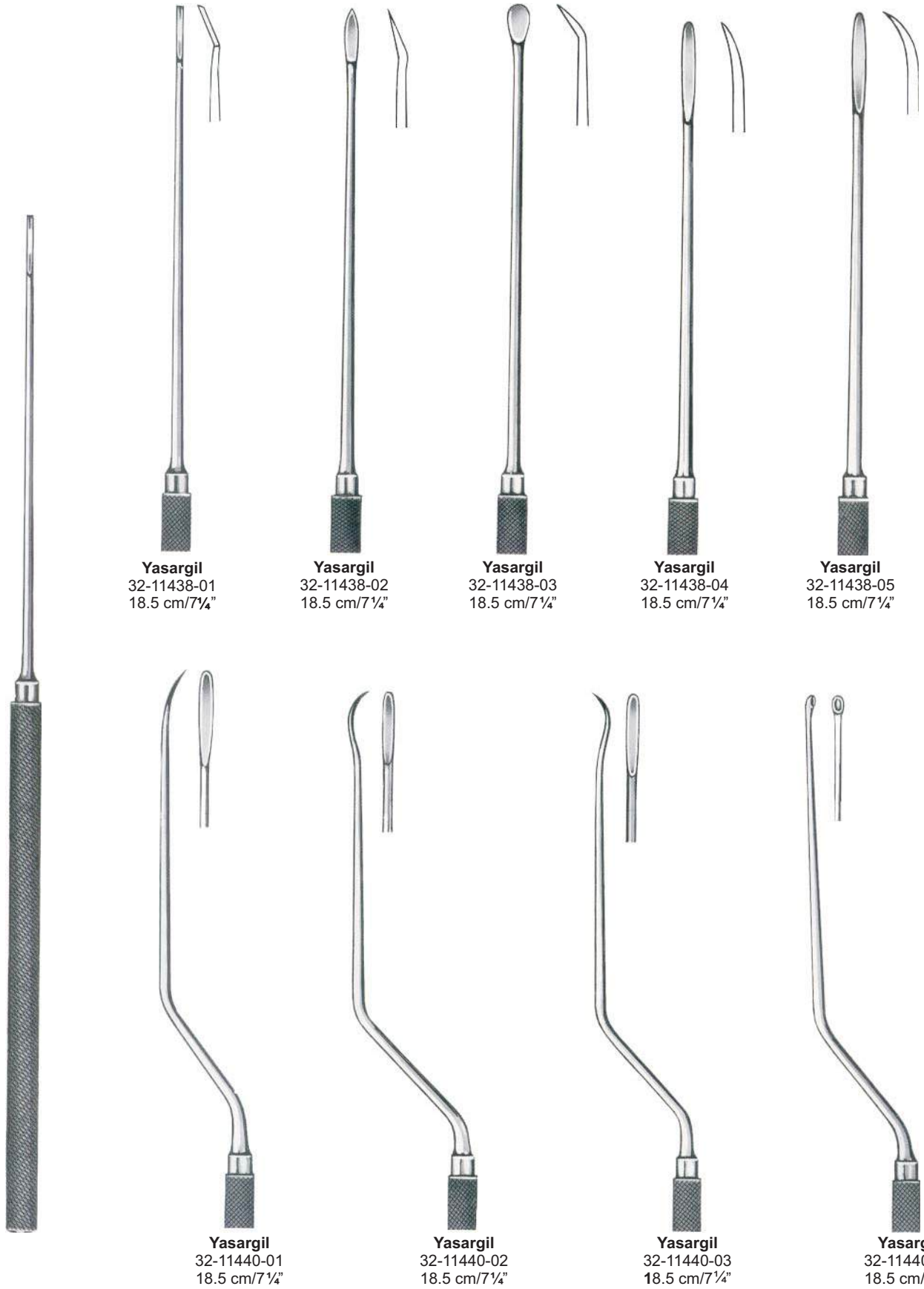

Yasargil
32-11438-01
18.5 cm/7 1/4"

Yasargil
32-11438-02
18.5 cm/7 1/4"

Yasargil
32-11438-03
18.5 cm/7 1/4"

Yasargil
32-11438-04
18.5 cm/7 1/4"

Yasargil
32-11438-05
18.5 cm/7 1/4"

Yasargil
32-11440-01
18.5 cm/7 1/4"

Yasargil
32-11440-02
18.5 cm/7 1/4"

Yasargil
32-11440-03
18.5 cm/7 1/4"

Yasargil
32-11440-04
18.5 cm/7 1/4"



32-11444-01
18.5 cm/7¼"



32-11444-02
18.5 cm/7¼"



krayenbuhl
32-11448-01
18.5 cm/7¼"



32-11448-02



32-11448-03



32-11448-04



Yasargil
32-11450-01
18.5 cm/7¼"



Yasargil
32-11450-02
18.5 cm/7¼"



Yasargil
32-11450-03
18.5 cm/7¼"



Yasargil
32-11450-04
18.5 cm/7¼"



Tissue Pick
32-11454-11
11 cm/4 1/8"

Tissue Pick
32-11456-10 1.0 mm
32-11456-18 1.8 mm
18.5 cm/7 1/4"

Vessel Dilator
32-11460-05 0.5 mm
32-11460-10 1.0 mm
32-11460-15 1.5 mm
12.5 cm/5"

Jacobson
Probe
32-11464-01
18.5 cm/7 1/4"

Vessel Probe
32-11464-02

Suture Pusher
32-11464-03



Rhoton
19 cm/7½"



Dissector Round
32-11470-01
Ø 1 mm



Dissector Round
32-11470-02
Ø 2 mm



Dissector Round
32-11470-03
Ø 3 mm



Dissector Spatula Shaped
32-11470-04
Ø 1 mm



Dissector Spatula Shaped
32-11470-05
Ø 1.5 mm



Dissector Spatula Shaped
32-11470-06
Ø 2.0 mm



Elevator
32-11470-07
Ø 1.2 mm



Elevator
32-11470-08
Ø 2.8 mm



Needle Semi-Sharp
32-11470-09



Hook Blunt
32-11470-10
90° 2 mm



Hook Semi-Sharp
32-11470-11
90° 2 mm



Hook Semi-Sharp
32-11470-12
45° 3 mm



Probe Angled
32-11470-13
90°



Probe Angled
32-11470-14
1.0 x 2.0 mm



Probe Angled
32-11470-15
1.0 x 2.0 mm
45°



Jannetta
19 cm/7½"

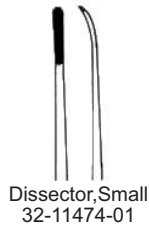

Dissector, Small
32-11474-01



Dissector, large
32-11474-02

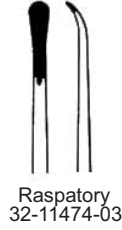

Raspatory
32-11474-03



Hook, Small
32-11474-04
90°



Hook Medium
32-1474-05
90°



Hook large
32-1474-06
90°



Hook Angular
32-1474-07
45°



Hook Medium
32-1474-08
45°



Elevator Angula
32-1474-09

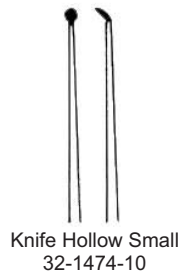

Knife Hollow Small
32-1474-10

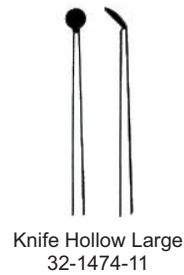

Knife Hollow Large
32-1474-11



Probe ball-tipped
32-1474-12

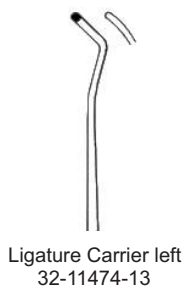

Ligature Carrier left
32-11474-13

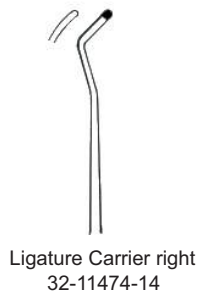

Ligature Carrier right
32-11474-14

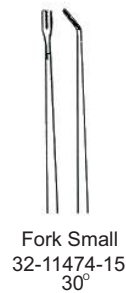

Fork Small
32-11474-15
30°

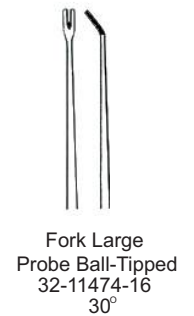

Fork Large
Probe Ball-Tipped
32-11474-16
30°



19 cm/7½"

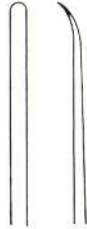

Micro Dissectors
32-11478-01
2 mm



32-11478-02
5mm



32-11478-03
8mm

Nerve Hooks



32-11478-04
3mm



32-11478-05
5mm

Micro Ligature Needle



Samil
20 cm/8"
23 cm/9"



32-11482-01
32-11484-01
1.0 x 5.0 mm



20 cm/8"
23 cm/9"



32-11482-02
32-11484-02
1.5 x 5.0 mm



32-11482-03
32-11484-03
2.0 x 5.5 mm



20 cm/8"
23 cm/9"



32-11482-04
32-11484-04
2.5 x 6.0 mm



32-11482-05
32-11484-05
3.0 x 7.0 mm



20 cm/8"
23 cm/9"



32-11482-06
32-11484-06
3.5 x 7.0 mm



32-11482-07
32-11484-07
4.0 x 7.5 mm



20 cm/8"
23 cm/9"



32-11482-08
32-11484-08
5.0 x 8.0 mm

Working Length
12.5 cm/5"

Angled up 32-11488-01
Curved down 32-11488-02
Curved right 32-11488-03
Curved left 32-11488-04

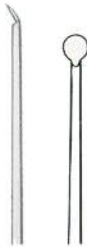

Curved upwards
32-11488-05



Angled up
32-11488-06
1.0 x 1.0 mm



Angled up
32-11488-07
2.5 x 5 mm



Curved up
32-11488-08
1.0 x 4 mm



Curved up
32-11488-09
1.5 x 5 mm



Straight
32-11488-10
0.4 mm



Curved up
32-11488-11
2.0 x 6 mm



Angled Up 32-11488-12
3 x 5 mm
Angled To Right 32-11488-13
3 x 5 mm
Angled To Left 32-11488-14
3 x 5 mm

24 cm/9 1/2"

12.5 cm/5"



24 cm/9½"



Blunt
32-11492-01
32-11494-01
32-11496-01
90° 2 mm



Blunt
32-11492-02
32-11494-02
32-11496-02
90° 2.5 mm



Semi-Sharp
32-11492-03
32-11494-03
32-11496-03
90° 2 mm



Blunt
32-11492-04
32-11494-04
32-11496-04
90° 3 mm



Ball Pointed
32-11492-05
32-11494-05
32-11496-05
90° 3 mm



Blunt
32-11492-06
32-11494-06
32-11496-06
30° 3 mm

Working Length
12.5 cm/5"



24 cm/9½"



22 cm/8¾"
24 cm/9½"

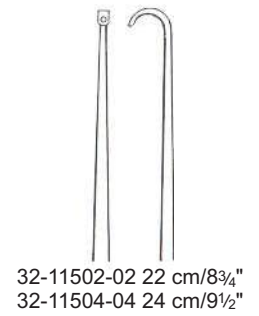
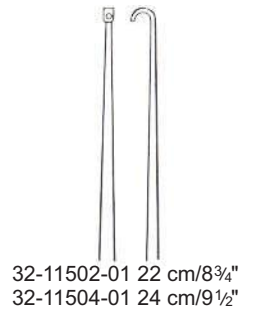



Hardy
24 cm/9½"

Sickle Dissectors



- Angled Up 32-11508-01
- Curved Down 32-11508-02
- Curved Right 32-11508-03
- Curved Left 32-11508-04



Implant Fork
32-11508-07

Hardy



- Angled Up 32-11508-08
- Curved Down 32-11508-09
- Curved Right 32-11508-10
- Curved Left 32-11508-11

2 mm



Hardy-Fahlbusch
32-11508-05



Hardy-Fahlbusch
32-11508-06

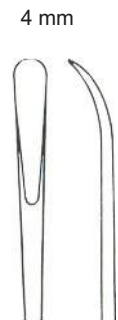

- Angled Up 32-11508-12
- Curved Down 32-11508-13

4 mm



24 cm/9½"

Spatula Dissectors



Straight
32-11512-03
5 x 20 mm

Curved Up Flexible
32-11512-01
8 x 100 mm

Curved Down Flexible
32-11512-02
8 x 100 mm



32-11512-06
32-11512-07
2 mm

Dissectors Angled



Sharp Angled Up
32-11512-04
5 mm
Sharp Angled Down
32-11512-05

Raspatories









Curved Up
Curved Down

32-11512-08
32-11512-09
4 mm



24 cm/9½"

Right	Up Down Right Left				
		32-11516-01 32-11518-01 32-11520-01 32-11522-01 Ø 2.5 mm 90°	32-11516-02 32-11518-02 32-11520-02 32-11522-02 Ø 4.0 mm 90°	32-11516-03 32-11518-03 32-11520-03 32-11522-03 Ø 5.0 mm 90°	
	Down	Up Down Right Left			
			32-11516-04 32-11518-04 32-11520-04 32-11522-04 25 mm 45°	32-11516-05 32-11518-05 32-11520-05 32-11522-05 40 mm 45°	32-11516-06 32-11518-06 32-11520-06 32-11522-06 5 mm 45°



24 cm/9½"

Malleable



With Stick

Up
Down
Right
Left

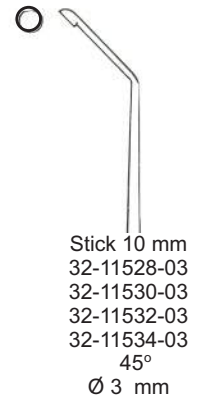
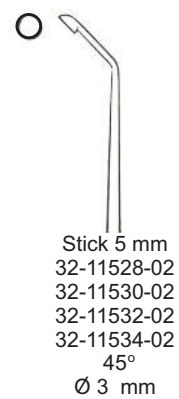



Sharp
32-11538-01
24 cm/9½"



32-11538-02

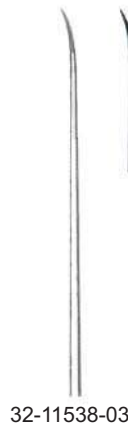

32-11538-03

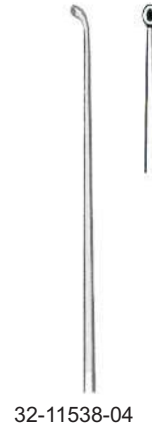

32-11538-04



32-11538-05



32-11538-06
2.5 mm



32-11538-07
3 mm



32-11538-08
3 mm



32-11538-09
5 mm



32-11538-10
8 mm

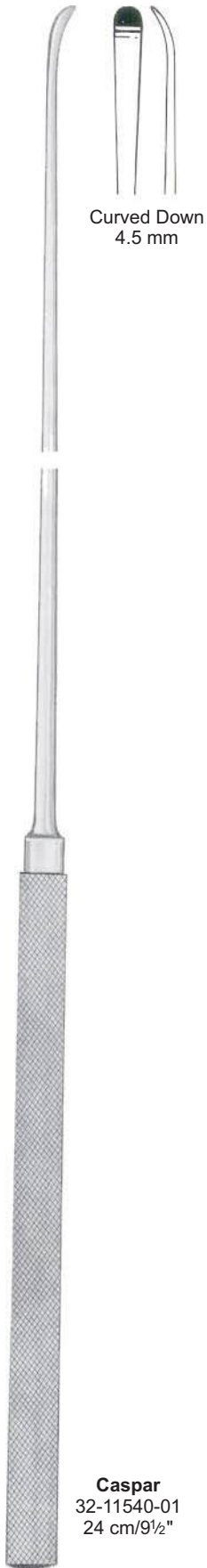

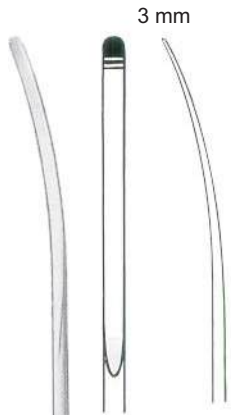

32-11542-01
19 cm/7½"



32-11542-02
21.5 cm/8½"

Curette



Ray
19 cm/7½"



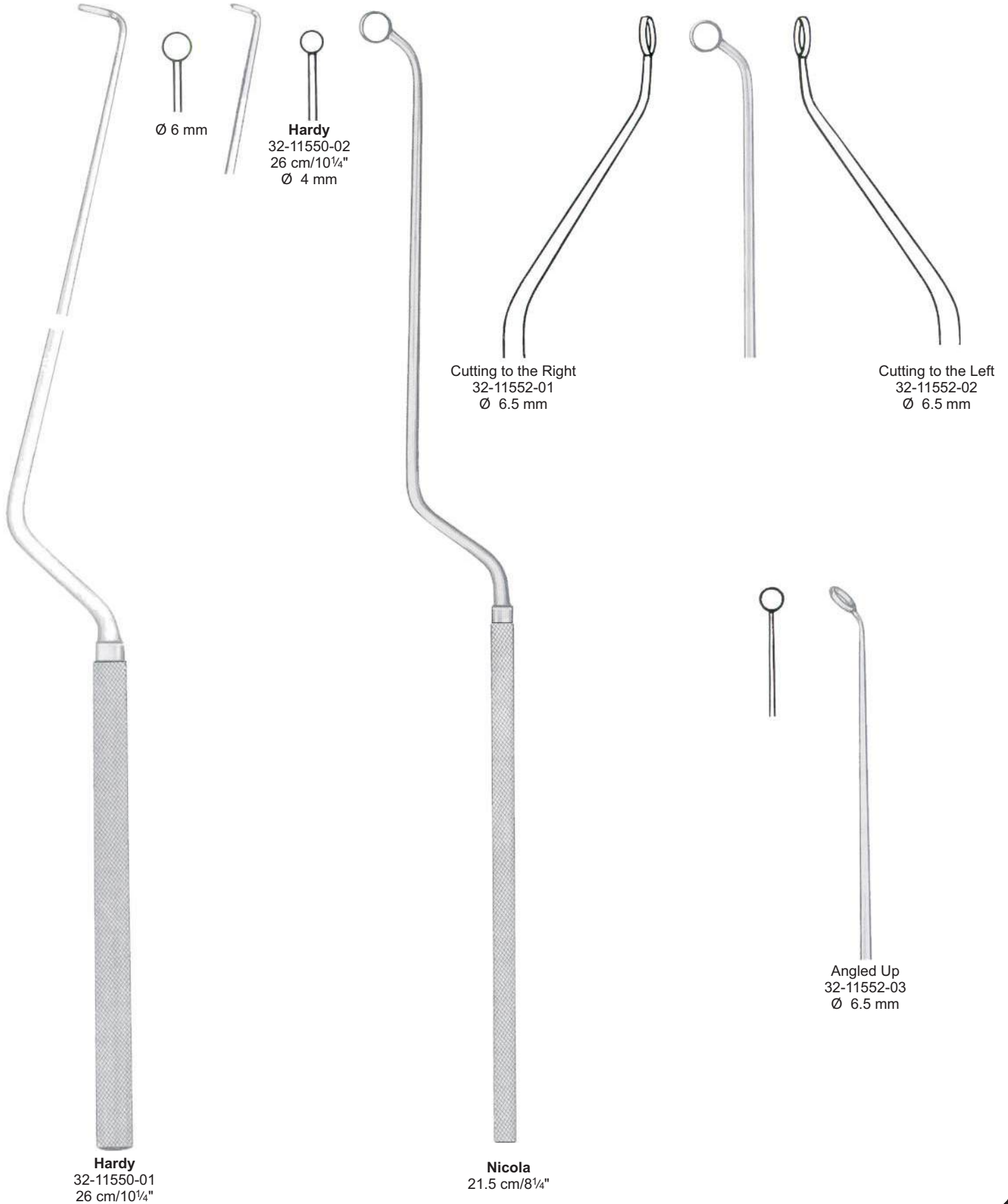



Enucleators Blunt Malleable



26 cm/10 3/4"



Landolt-Reulen
Dissector rigid
32-11562-01
2mm



Landolt-Reulen
Blunt Hook rigid
32-11562-02
1.7mm



Fahlbusch
Curette malleable
32-11562-03
2.5 mm Ø



Landolt-Reulen
Curette rigid
32-11562-04
2.5 mm Ø



Fahlbusch
Scoop malleable
32-11562-05



Landolt-Reulen
Raspatory rigid
32-11562-06
2.2 mm
3.2 mm

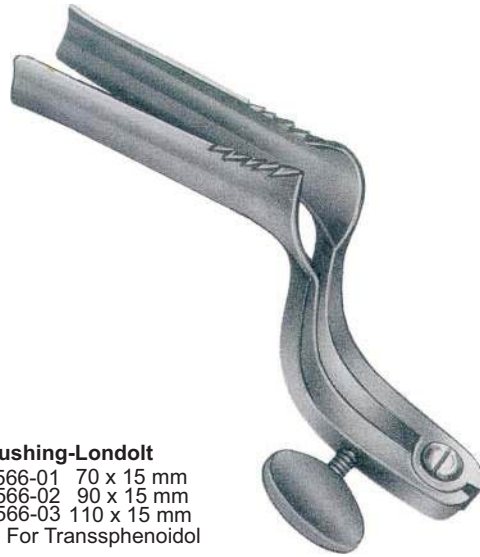

Cushing-Londolt
32-11566-01 70 x 15 mm
32-11566-02 90 x 15 mm
32-11566-03 110 x 15 mm
Specula For Transssphenoidol

Mirrors



32-11570-06
6 mm



32-11570-08
8 mm



32-11570-10
10 mm



32-11570-12
12mm



Mirror handle
32-11570-00

Ø=Inside Dia



Troltsch
For Babies

Fig. 1 33-11574-01 1.5 mm Ø
Fig. 2 33-11574-02 2.5 mm Ø
Fig. 3 33-11574-03 3.5 mm Ø

33-11574-30
Set of 3
Fig 1-3



Troltsch
For Adults

Fig. 4 33-11574-04 4.0 mm Ø
Fig. 5 33-11574-05 5.0 mm Ø
Fig. 6 33-11574-06 6.0 mm Ø
Fig. 7 33-11574-07 7.0 mm Ø

33-11574-30 33-11574-40
Set of 3 Set of 4
Fig 4-6 Fig 4-7



Poltzer

Fig. 1 33-11578-01 2.0 mm Ø
Fig. 2 33-11578-02 3.0 mm Ø
Fig. 3 33-11578-03 4.0 mm Ø

33-12278-30
Set of 3
Fig 1-3



Erhard
For Adults

Fig. 1 33-11582-01 3.0 mm Ø
Fig. 2 33-11582-02 4.0 mm Ø
Fig. 3 33-11582-03 5.0 mm Ø
Fig. 4 33-11582-04 6.0 mm Ø

33-11582-30 33-11582-40
Set of 3 Set of 4
Fig.1-3 Fig.1-4



Hartmann
For Babies

Fig. 1 33-11586-01 2.0 mm Ø



Hartmann
For Children

Fig. 2 33-11586-02 3.0 mm Ø
Fig. 3 33-11586-03 4.0 mm Ø
Fig. 4 33-11586-04 5.5 mm Ø

33-11586-30
Set of 3
Fig.2-4



Hartmann
For Adults

Fig. 3 33-11590-03 4.0 mm Ø
Fig. 4 33-11590-04 5.5 mm Ø
Fig. 5 33-11590-05 6.5 mm Ø
Fig. 6 33-11590-06 7.5 mm Ø

33-11590-30 33-11590-40
Set of 3 Set of 4
Fig.4-6 Fig.3-6



Toynbee
For Adults

Fig. 1 33-11594-01 4.5 mm Ø
Fig. 2 33-11594-02 5.5 mm Ø
Fig. 3 33-11594-03 6.5 mm Ø
Fig. 4 33-11594-04 7.5 mm Ø

33-11594-30 33-11594-40
Set of 3 Set of 4
Fig.2-4 Fig.1-4

Alu Black



33-11598-60
Set of 6
Fig. 1-6

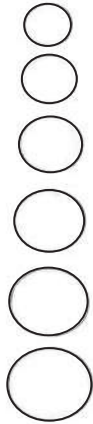

Ø=Inside Dia

- Fig. 1 33-11598-01
4.5 x 5.5 mm Ø
- Fig. 2 33-11598-02
5.5 x 6.5 mm Ø
- Fig. 3 33-11598-03
6.5 x 7.5 mm Ø
- Fig. 4 33-11598-04
7.5 x 8.5 mm Ø
- Fig. 5 33-11598-05
8.5 x 9.5 mm Ø
- Fig. 6 33-11598-06
9.5 x 10.5 mm Ø



Gruber

- 33-11602-30 Set of 3 Fig. 2-4
- 33-11602-40 Set of 4 Fig. 1-4
- 33-11604-40 Set of 3 Fig. 2-4
- 33-11604-40 Set of 4 Fig. 1-4

- Fig. 1 33-11602-01
2.8 x 3.8 mm Ø
- Fig. 2 33-11602-02
3.8 x 4.8 mm Ø
- Fig. 3 33-11602-03
5.0 x 6.2 mm Ø
- Fig. 4 33-11602-04
6.0 x 7.2 mm Ø
- Fig. 1 33-11604-01
4.5 mm Ø
- Fig. 2 33-11604-02
5.0 mm Ø
- Fig. 3 33-11604-03
5.5 mm Ø
- Fig. 4 33-11604-04
6.0 mm Ø

Black



Hartmann
33-11608-40
Set of 4
Fig. 1-4

- Fig. 1 33-11608-01
3.0 mm Ø
- Fig. 2 33-11608-02
4.0 mm Ø
- Fig. 3 33-11608-03
5.0 mm Ø
- Fig. 4 33-11608-04
7.0 mm Ø

Black



Hartmann
33-11608-20
Set of 2
Fig. 5-6

- Fig. 5 33-11608-05
9.0 mm Ø
- Fig. 6 33-11608-06
11.0 mm Ø



Boucheron
33-11612-40
Set of 4
Fig. 3-6

- 33-11612-03 3.5 mm Ø
- 33-11612-04 4.5 mm Ø
- 33-11612-05 5.5 mm Ø
- 33-11612-06 6.5 mm Ø



33-11618-01



33-11618-02



33-11618-03

- Fig. 1 33-11618-01 4.2 x 3.8 mm
- Fig. 2 33-11618-02 5.5 x 3.8 mm
- Fig. 3 33-11618-03 6.5 x 3.8 mm
- 33-11618-30
Set of 3
Fig. 1-3



33-11620-01



33-11620-02



33-11620-03

Fig. 1 33-11620-01 4.2 mm
 Fig. 2 33-11620-02 5.5 mm
 Fig. 3 33-11620-03 6.5 mm
 33-11620-30
 Set of 3
 Fig. 1-3



Richnau-Holmgren
 33-11628-02 2.0 mm Ø
 33-11628-04 4.0 mm Ø
 33-11628-06 6.0 mm Ø

Metal supports for specula

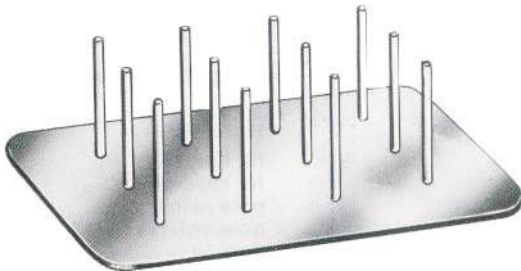

For 12 Specula
 33-11624-00



Siegle



6.5 mm 7 mm 8 mm

Otoscope with 3 ear specula and rubber tube with bulb
 33-11632-00

Tuning Forks



Hartmann



Lucae



**French
Hartmann**



**Lucae
C 128**



**Hartmann
C 128**

Variable up to h (Engl. B)

33-11648-00

33-11652-00

C ₂	16			33-11644-16
C ₂	32			33-11644-32
C	64			33-11645-01
C	128	33-11636-00	33-11640-00	33-11645-02
C ₁	256	33-11636-01	33-11640-01	33-11645-03
C ₂	512	33-11636-02	33-11640-02	
C ₃	1024	33-11636-03	33-11640-03	
C ₄	2048	33-11636-04	33-11640-04	
C ₅	4096	33-11636-05	33-11640-05	



Rydel-Seiffer
33-11656-00
C 64/C 128

With Clamps = C 64
Without Clamps = C 128



Tuning Fork for neurological examination, with percussion hammer, pin wheel, brush and needle

33-11660-00



33-11664-01
C 64



33-11664-02
C 128



33-11664-03
C 256



33-11664-04
C 512



33-11664-05
C 1024



33-11664-06
C 2048



33-11664-07
C 4096



Hartmann

- 33-11668-20
2.0 mm Ø
- 33-11668-25
2.5 mm Ø
- 33-11668-30
3.0 mm Ø
- 33-11668-40
4.0 mm Ø
- 33-11668-50
5.0 mm Ø



Itard

- 33-11672-30
3 mm Ø
- 33-11672-35
3.5 mm Ø
- 33-11672-40
4 mm Ø
- 33-11672-45
4.5 mm Ø
- 33-11672-50
5 mm Ø

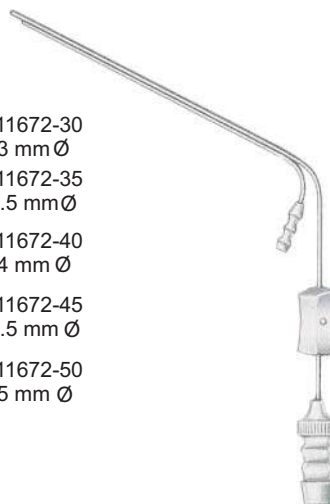

House
33-11676-09 0.9 mm Ø
33-11676-12 1.2 mm Ø
33-11676-15 1.5 mm Ø



Baron (Schuknecht)
33-11680-01 1.0 x 75 mm Ø
33-11680-02 1.5 x 75 mm Ø
33-11680-03 2.0 x 75 mm Ø



Krause
33-11684-16
16 cm/6¼"



Krause-Voss
33-11688-16
16 cm/6¼"

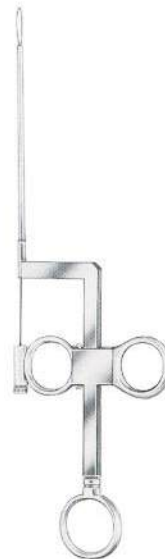

Lange-Wilde
33-11692-16
16 cm/6¼"



Package of 1 dozen each

	mm Ø
33-11700-02	0.2
33-11700-03	0.3

Ear Dressing Forceps



**Troeltsch
(Wilde)**



Troeltsch



Lucae



Lucae



Jansen

Cm	In				
11.0	4¼"	33-11704-11			
12.0	4¾"	33-11704-12	33-11706-12		33-11712-14
14.0	5½"	33-11704-14		33-11710-14	
15.0	6"	33-11704-15			
16.0	6¼"				33-11716-16
18.0	7"				33-11716-18
20.0	8"				33-11716-20



Okonogto
33-11720-16
16 cm/6¼"



Littauer
33-11724-12
12 cm/4¾"



Fine Pattern

Hartmann
33-11726-12
12 cm/4¾"



Hartmann
33-11728-14
14 cm/5½"

Standard Pattern

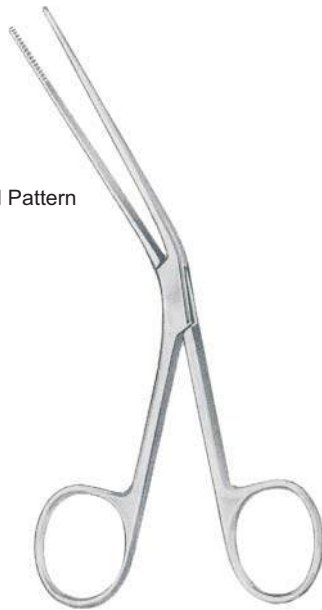

Tilley
33-11732-14
33-11732-16
14 cm/5½"



Buck
33-11736-09
9 cm/3½"

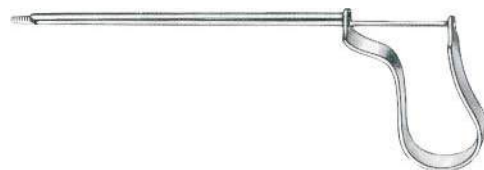

Quire
33-11740-08
8 cm/3¼"

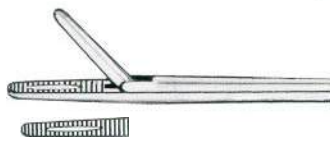

Hartmann-Noyes
33-11744-09
8.5 cm/3¼"

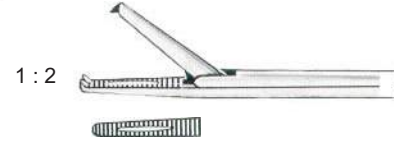

1 : 2

Hartmann-Noyes
33-11746-09
8.5 cm/3¼"



Hartmann
33-11750-09 8.5 cm/3¼"
33-11750-14 14 cm/5½"
33-11750-16 16 cm/6¼"



1 : 2

Hartmann
33-11752-09 8.5 cm/3¼"
33-11752-14 14.0 cm/5½"



Hartmann
33-11756-20 8.5 cm/3¼" ○ 2.0 mm
33-11756-25 8.5 cm/3¼" ○ 2.5 mm
33-11756-30 8.5 cm/3¼" ○ 3.0 mm



Hartmann-Citelli
33-11760-02 ○ 2 mm 8.5 cm/3¼"
33-11760-03 ○ 3 mm 8.5 cm/3¼"



Strumpel
33-11762-09
8.5 cm/3¼"



Hartamm-Weingartner
33-11766-09
8.5 cm/3¼"



Hartamm
33-11770-09
8.5 cm/3¼"















Hartamm-Wullstein
33-11774-06 8.5 cm/3¼" 08 x 6 mm
33-11774-08 8.5 cm/3¼" 1.8 x 8 mm



Hartamm-Wullstein
33-11778-01 ○ 1 mm 8.5 cm/3¼"
33-11778-02 ○ 2 mm 8.5 cm/3¼"



Length of Shaft 8 cm

	Micro Forceps	Mini	Cup-Shaped Forceps
	1.6 x 7.0 mm  33-11782-01	0.7 x 3.5 mm  33-11782-08	0.9 x 1.1 mm  33-11782-11
	 33-11782-02 0.8 x 4.0 mm		
Smooth Jaw	 33-11782-03 0.8 x 6.0 mm		
Curved Left	 33-11782-04 0.8 x 6.0 mm		 33-11782-12 0.9 x 1.1 mm
Curved Right	 33-11782-05 0.8 x 4.0 mm		 33-11782-13 0.9 x 1.1 mm
Angled Up	 33-11782-06 0.8 x 4.0 mm		 33-11782-14 0.9 x 1.1 mm
Angled Down	 33-11782-07 0.8 x 4.0 mm		 33-11782-15 0.9 x 1.1 mm

Micro Forceps



Greven
33-11782-16
0.8 x 5.0 mm



Cos
33-11782-18
0.8 x 3.0 mm

Left Angled



Juers
33-11782-19
0.8 x 6.0 mm



Hough
33-11782-21
0.8 x 3.0 mm

Right Angled



Juers
33-11782-20
0.8 x 6.0 mm



Hough
33-11782-22
0.8 x 3.0 mm



Fuller
33-11782-23
0.8 x 6.0 mm



Tabb
33-11782-24

Upward Cutting



Dieter
33-11782-30

Downward Cutting



Dieter
33-11782-31

Cutting to the Right



Dieter
33-11782-32

Cutting to the left



Dieter
33-11782-33

Micro Scissors



Bellucci
33-11786-01
4.0 mm



Bellucci
33-11786-02
5.5 mm

Angled Up



Bellucci
33-11786-03
5.5 mm

Curved Left



Bellucci
33-11786-04
5.5 mm

Curved Right



Bellucci
33-11786-05
5.5 mm



Shea
33-11786-06
7.0 mm

Curved Left



Shea
33-11786-07
7.0 mm

Curved Right



Shea
33-11786-08
7.0 mm



Length of Shaft 8 cm

Micro Forceps

0.5 mm

Smooth Jaw

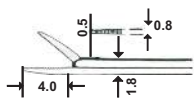

Straight

33-11790-01

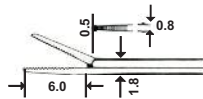

33-11790-02

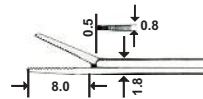

33-11790-03

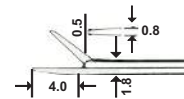

33-11790-04

Curved Right
Curved Left
Angled Up
Angled Down

33-11794-01
33-11794-02
33-11794-03
33-11794-04

Micro Forceps

0.3 mm

Smooth Jaw

Straight

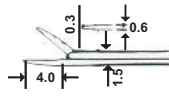

33-11800-01

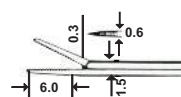

33-11800-02

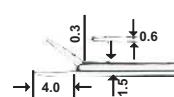

33-11800-03

Length of Shaft 8 cm

Cup-Shaped Forceps



Micro Scissors



Bellucci
0.8 mm

1.5 x 0.8 mm

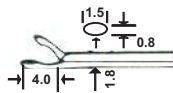

- | | |
|--------------|-------------|
| Straight | 33-11804-01 |
| Curved Right | 33-11804-02 |
| Curved Left | 33-11804-03 |
| Angled Up | 33-11804-04 |
| Angled Down | 33-11804-05 |

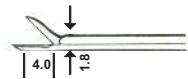

- | |
|-------------|
| 33-11806-01 |
| 33-11806-02 |
| 33-11806-03 |
| 33-11806-04 |
| 33-11806-05 |

1.0 x 0.5 mm

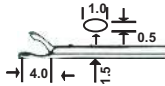

- | | |
|----------|-------------|
| Straight | 33-11804-06 |
|----------|-------------|

Length of Shaft 8 cm



Crura Forceps



Open to Right

Fisch
33-11810-01



Open to Left

Fisch
33-11810-02

Length of Shaft 8 cm



Wire Closure Forceps



Mc Gee
33-11814-01



Mc Gee/Fisch
33-11814-02

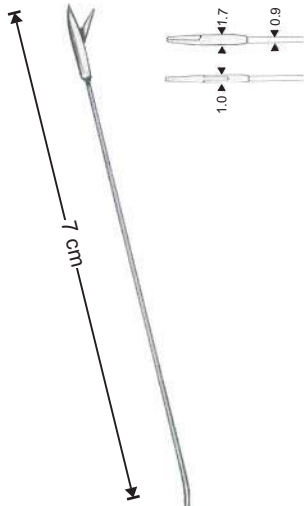

Micro Scissors



Micro Forceps



Cup-Shaped Forceps

Messer



Schuknecht
33-11826-01

Schuknecht
33-11826-02

Schuknecht
33-11828-01

Knives



Wullstein
33-11830-01



Tabb
33-11832-01



Plester
33-11834-01



Plester
33-11834-02

33-11834-03



Rosen

33-11838-20
2.0 mm



33-11838-10
1.0 mm



33-11838-14
1.4 mm



33-11838-16
1.6 mm



33-11838-26
2.6 mm



33-11838-28
2.8 mm



33-11838-30
3.0 mm

Needles And Hooks



Barbara
33-11842-01



33-11842-02



33-11842-03



Rosen
33-11842-04



Barbara



25°
33-11844-03 0.3 mm
33-11844-06 0.6 mm
33-11844-10 1.0 mm



45°
33-11846-03 0.3 mm
33-11846-06 0.6 mm
33-11846-10 1.0 mm
33-11846-12 1.2 mm
33-11846-15 1.5 mm
33-11846-20 2.0 mm
33-11846-25 2.5 mm



90°
33-11848-03 0.3 mm
33-11848-06 0.6 mm
33-11848-10 1.0 mm
33-11848-12 1.2 mm
33-11848-15 1.5 mm
33-11848-20 2.0 mm
33-11848-25 2.5 mm



33-11850-05 0.5 mm
33-11850-10 1.0 mm

Needles And Hooks



90°
33-11852-03 0.3 mm
33-11852-06 0.6 mm
33-11852-10 1.0 mm

90°
33-11854-03 0.3 mm
33-11854-06 0.6 mm
33-11854-10 1.0 mm

McGee
33-11856-05 0.5 mm
33-11856-10 1.0 mm

McGee
33-11858-05 0.5 mm
33-11858-10 1.0 mm

Barbara
33-11860-01

Rosen
33-11860-02



25°
33-11862-03 0.3 mm
33-11862-06 0.6 mm
33-11862-10 1.0 mm

25°
33-11864-03 0.3 mm
33-11864-06 0.6 mm
33-11864-10 1.0 mm

45°
33-11868-03 0.3 mm
33-11868-06 0.6 mm
33-11868-10 1.0 mm

45°
33-11870-03 0.3 mm
33-11870-06 0.6 mm
33-11870-10 1.0 mm

Dissectors, Measuring Road, Elevators, Curettes and Mobilizer



Fisch



33-11874-01



33-11874-02



33-11874-03



33-11874-04



Rosen

33-11878-15 33-11878-25
1.5 mm 2.5 mm



Rosen



33-11880-01



33-11880-02



33-11880-03



33-11880-04



33-11880-05



33-11880-06



House



33-11882-01
3.5 mm



33-11882-02
4.0 mm



33-11882-03
4.5 mm



33-11882-04
5.0 mm



Buckingham



33-11886-01



33-11886-02



33-11886-03



House

33-11890-10 1.0/1.2 mm
33-11890-15 1.5/1.8 mm



House

33-11892-10 1.0/1.2 mm
33-11892-15 1.5/1.8 mm



Shea

33-11896-15 1.5 mm





33-11900-01

33-11900-02

33-11900-03

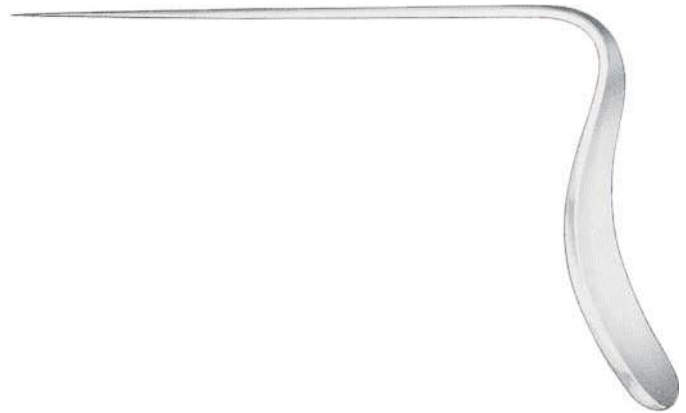

Zollner



33-11900-04

33-11900-05

33-11900-06

33-11900-07

33-11900-08

33-11900-09

33-11900-10

33-11900-11



33-11900-12



33-11900-13

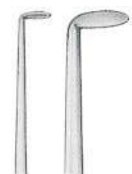

33-11900-14



33-11900-15



33-11900-16



33-11900-17



33-11900-18



33-11900-19



33-11900-20



33-11900-21



33-11900-22



33-11900-23



33-11900-24



Width of Bite

Citelli
33-11904-20 2.0 mm
33-11904-30 3.0 mm



Width of Bite

Citelli-Beyer
33-11906-15 1.5 mm
33-11906-20 2.0 mm



Width of Bite







Brunings
33-11910-40
33-11910-60

-  33-11912-30 3.0 mm
-  33-11912-40 4.0 mm
-  33-11912-50 5.0 mm
-  33-11912-60 6.0 mm



Kerrison
20 cm/8"



		Fig. 000	00	0	1	2	3	4	5
Blunt		33-11914-30	33-11914-20	33-11914-10	33-11914-01	33-11914-02	33-11914-03	33-11914-04	33-11914-05
Sharp		33-11915-30	33-11915-20	33-11915-10	33-11915-01	33-11915-02	33-11915-03	33-11915-04	33-11915-05
Blunt		33-11916-30	33-11916-20	33-11916-10	33-11916-01	33-11916-02	33-11916-03	33-11916-04	33-11916-05
Sharp		33-11917-30	33-11917-20	33-11917-10	33-11917-01	33-11917-02	33-11917-03	33-11917-04	33-11917-05





Gross
33-11944-12
12 cm/4¾"



Zaufal
33-11948-16
16 cm/6¼"



Hartmann
33-11952-16
16 cm/6¼"



Lucae
14 cm/5½"

33-11956-01

33-11956-02

33-11956-03



Wagener
14 cm/5½"

33-11960-01

33-11960-02

33-11960-03

33-11960-04

33-11960-05

33-11960-06



Day
16 cm/6¼"

33-11964-01

33-11964-02



Muck
33-11968-13
13.5 cm/5⅛"



Politzer
33-11972-16
16 cm/6¼"



Fig. Straight Sexton
1 33-11976-01
2 33-11976-02
3 33-11976-03



Curved Sexton
33-11980-01
33-11980-02
33-11980-03



Gerzog-Sexton
33-11984-17
17 cm/6½"

Messer



Poltzer
33-11988-17
17 cm/6¾"



Lempert
33-11992-15
15 cm/6 "



Lempert
15 cm/6"



33-11996-01



33-11996-02



Lempert
33-12000-01
15 cm/6"

Knives



Lempert
33-12000-02
15 cm/6"



Poltzer
33-12004-16
16.5 cm/6½"



Lucae
33-12006-16
16 cm/6¼"
33-12006-18
18 cm/7"

Lucae
33-12008-18
18 cm/7 "



Poltzer
33-12012-17
17 cm/6¾"



Ear Operating Set



Sprague
33-12014-19
19 cm/7½"



33-12018-10



33-12018-20



33-12018-30

Ear Syringe, Complete With 2 Cannulas and 1Protecting Disk

- 33-12018-02 50 ml
- 33-12018-03 75 ml
- 33-12018-04 100 ml
- 33-12018-06 150 ml
- 33-12018-08 200 ml



Fraenkel
34-12022-01 Fig. 1
34-12022-02 Fig. 2
34-12022-03 Fig. 3



34-12026-01
34-12026-02
34-12026-03
13 cm/5"



Fig. 1
34-12026-01
34-12028-01

Fig. 2
34-12026-02
34-12028-02

Fig. 3
34-12026-03
34-12028-03



34-12028-01
34-12028-02
34-12028-03
13 cm/5"



Hartmann
15 cm/6"

34-12030-01

34-12030-02

34-12030-03

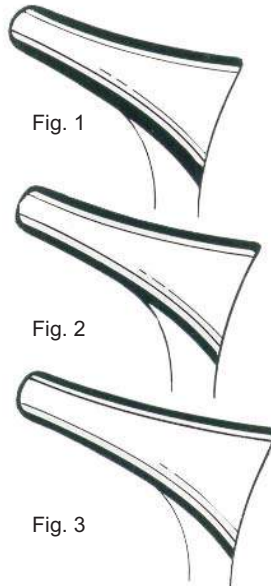

Fig. 1

Fig. 2

Fig. 3

34-12032-01

34-12032-02

34-12032-03



Hartmann
15 cm/6"



34-12036-01

34-12036-02

34-12036-03

Hartmann-Halle
15 cm/6"



Fig. 1



Fig. 2



Fig. 3



34-12038-01

34-12038-02

34-12038-03

Hartmann-Halle
15 cm/6"



34-12042-01

34-12042-02

Tieck
13.5 cm/5 1/4"



34-12044-01



34-12044-02



Tieck
13.5 cm/5 1/4"



Beckmann
15 cm/6"



Fig. 1
34-12048-01



Fig. 2
34-12048-02



Fig. 3
34-12048-03



Mod.Wien

34-12052-01

Fig.1



34-12052-02

Fig.2

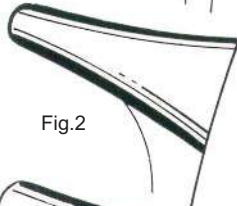

34-12052-03

Fig.3

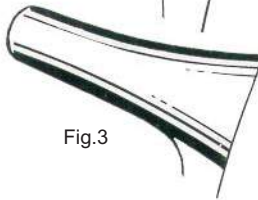

34-12054-01



Wien

34-12054-02

34-12054-03



Killian

Fig.1
34-12058-01
35 mm



Fig.2
34-12058-02
50 mm



Fig.3
34-12058-03
75 mm



Fig.4
34-12058-04
90 mm

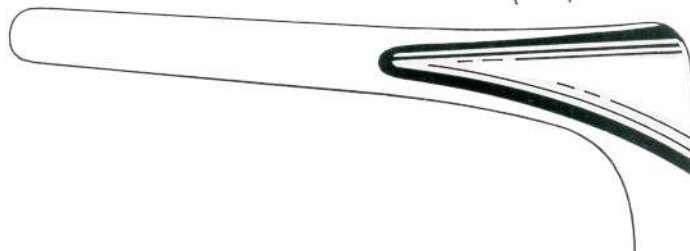



Cottle
34-12062-01
34-12062-02
34-12062-03
34-12062-04
15 cm/6"

Cottle
34-12064-01
34-12064-02
34-12064-03
34-12064-04
15 cm/6"



Fig 1
34-12062-01
34-12064-01
35 mm

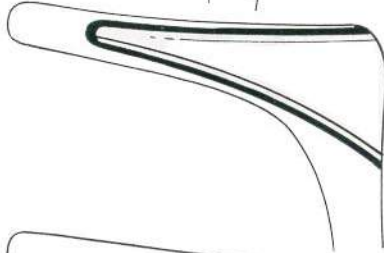

Fig 2
34-12062-02
34-12064-02
50 mm



Fig 3
34-12062-03
34-12064-03
75 mm

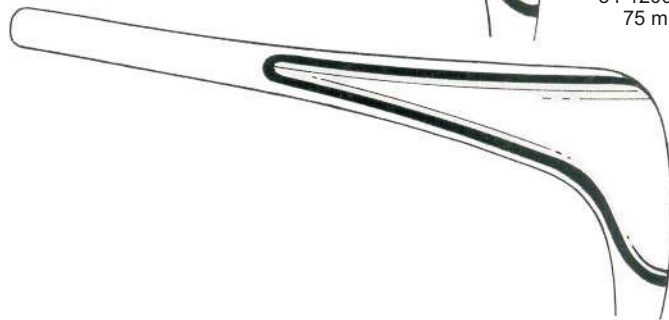
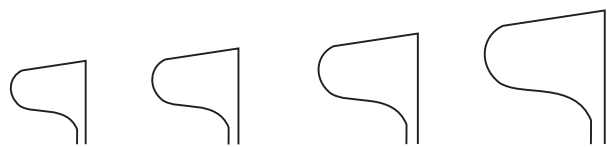

Fig 4
34-12062-04
34-12064-04
90 mm



34-12068-30 Fig. 1- 3
34-12068-40 Fig. 1- 4
34-12068-70 Fig. 1- 7



34-12068-01 34-12068-02 34-12068-03 34-12068-04



34-12068-05 34-12068-06 34-12068-07



Krause
34-12074-26
26 cm/10¹/₄"



Krause-Voss
34-12076-26
26 cm/10¹/₄"



Lange-Wilde
34-12078-24
24 cm/9¹/₂"



Package Of 1 Dozen Each
34-12080-10
0.3 mm



Cm	In
15.0	6
18.0	7
20.0	8



Cm	In
15.0	6
18.0	7
20.0	8



Westmacott (West)
34-12092-20
20 cm/8"



Lubet-Barbon
34-12096-20
20 cm/8"



Hartmann
34-13000-16
16 cm/6 1/2"



Hartmann
34-13002-20
20 cm/8"



Heymann
34-13006-18
18 cm/7"



Craig
34-13010-18
18 cm/7"



Craig Domnick
18 cm/7"



Luc
20 cm/8"



Luc
20 cm/8"



Bruenings
19 cm/7½"

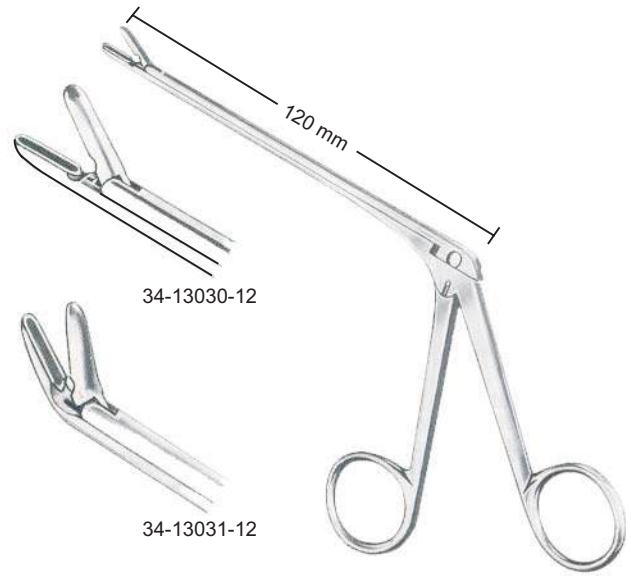

Takahashi
19 cm/7½"



Watson-Williams
19 cm/7½"



Ferris-Smith
34-13038-12
19 cm/7½"

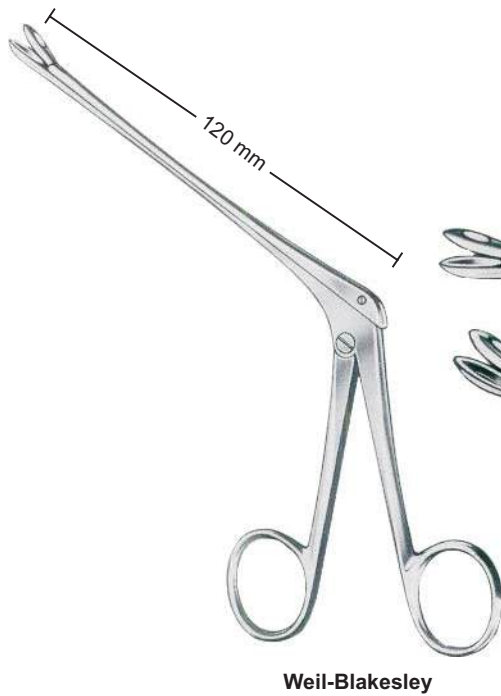

Weil-Blakesley



Struycken

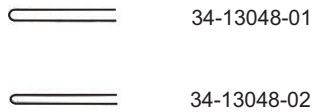

Hajek

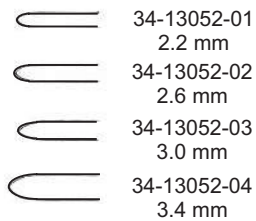

Myles

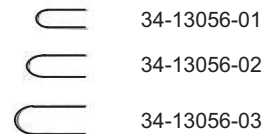

Grunwald

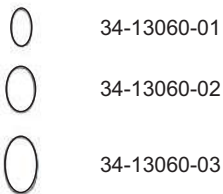

Hartmann

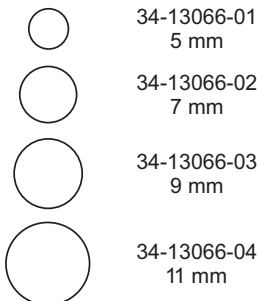

Schmeden

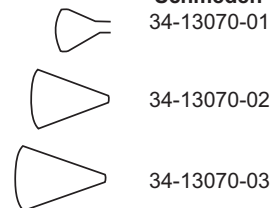

Grunwald
34-13062-01



Middleton-Jansen
34-13074-19
19 cm/7½"

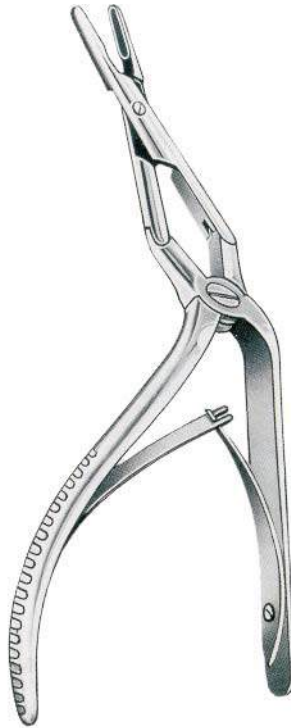

Middleton-Jansen
34-13076-19
19 cm/7½"



Kazanjian
34-13080-18
18 cm/7"



Caplan
34-13084-20
20 cm/8"



34-13088-01
5x4 mm



34-13088-02
5x4 mm



34-13088-03
5x3.5 mm



34-13088-04
5x3.5 mm

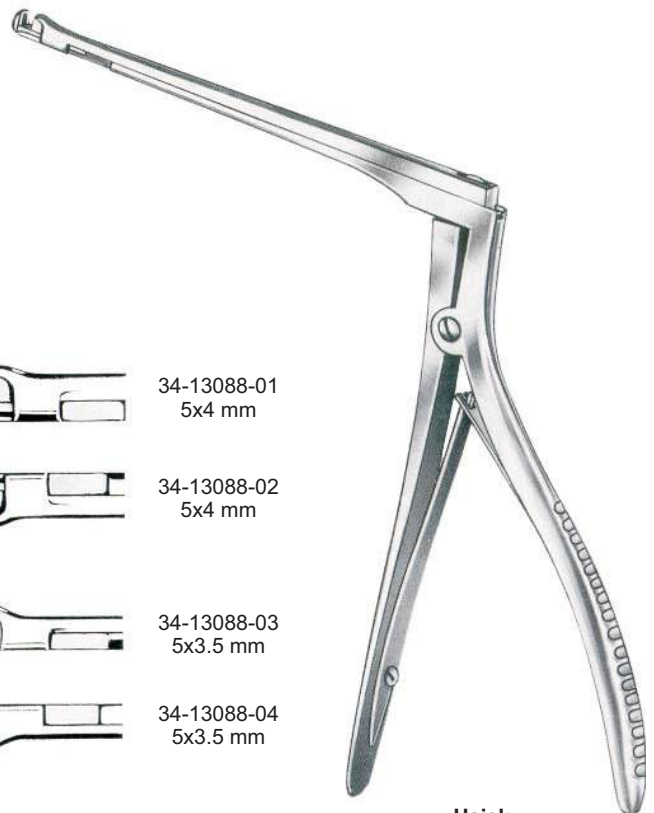



Hajek
(Hajek-Kofler)
Shaft
14 cm/5½"



Ferris-Smith-Kerrison



Ferris-Smith-Kerrison

	Width of Bite	Length of Shaft		Width of Bite	Length of Shaft		
		15 cm/6"	20 cm/8"		18 cm/7"	15 cm/6"	20 cm/8"
Cutting Upward 	3 mm	34-13092-03	34-13098-03	3 mm	34-13104-03	34-13114-03	34-13120-01
	5 mm	34-13092-05	34-13098-05	5 mm	34-13104-05	34-13114-05	34-13120-02
Cutting Upward 40° 	3 mm	34-13094-03	34-13100-03	3 mm	34-13110-03	34-13116-03	34-13122-01
	5 mm	34-13094-05	34-13100-05	5 mm	34-13110-05	34-13116-05	34-13122-02
Cutting Downward 	3 mm	34-13096-03	34-13102-03	3 mm	34-13106-03	34-13118-03	34-13122-03
	5 mm	34-13096-05	34-13102-05	5 mm	34-13106-05	34-13118-05	34-13122-04
				1 mm			34-13122-05
				2 mm			34-13124-01
				3 mm			34-13124-02
				4 mm			34-13124-03
				5 mm			34-13124-04
				1 mm			34-13124-05
				2 mm			
				3 mm			
				4 mm			
				5 mm			



360° Turnable

Hajek-Kofler
 34-13128-16
 16 cm/6½"

- 34-13132-03
- 3 mm
- 34-13132-04
- 4 mm
- 34-13132-05
- 5 mm
- 34-13132-06
- 6 mm



Kerrison
 20 cm/8"



Jurasz
22 cm/8¾"



34-13136-01



34-13136-02



34-13136-03

Rhinoplastic and Nasal Knives



Joseph
Pointed

← Straight
34-13140-01



Curved
34-13141-01



Joseph
Blunt

← Straight
34-13144-01



Curved
34-13145-01



Converse
34-13149-15
15 cm/6"



Joseph
34-13152-14
14 cm/5½"



Cottle
34-13156-15
15 cm/6"



Cottle
34-13158-14
14 cm/5½"



Freer
34-13162-16
16 cm/6¼"



Joseph
34-13166-16
16.5 cm/6½"



Maltz
34-13170-16
16.5 cm/6½"



Freer
34-13174-19
19 cm/7½"

Septum Knives



Ballenger
20cm/8"



34-13178-03 3 mm 34-13179-03
34-13178-04 4 mm 34-13179-04
34-13178-05 5 mm 34-13179-05



Ballenger
20cm/8"



Bruenings
34-13182-16
16cm/6¼"



34-13186-04 4 mm
34-13186-05 5 mm

Mc Kenty
15 cm/6"



Halle
34-13190-16
16.5 cm/6½"



Joseph
34-13194-16
16.5 cm/6½"



Cottle
34-13198-19
19.5 cm/7½"



Blunt

Freer
34-13202-19
19 cm/7½"



Sharp

Freer
34-13203-19
19 cm/7½"



Freer
34-13206-18
18 cm/7"

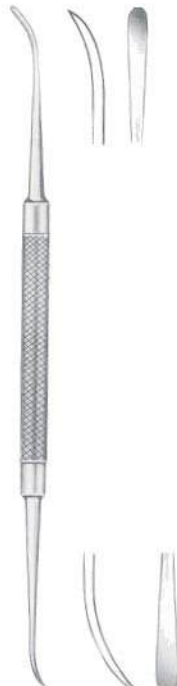

Freer-Yasargil
34-13208-18
18.5 cm/7¼"



Howarth
34-13212-21
21.5 cm/8½"



Mc Kenty
34-13216-22
22 cm/8¾"



Killian
34-13220-18
18.5 cm/7¼"



Cottle
34-13224-23
23 cm/9"



Killian
34-13228-18
18.5 cm/7¼"



Pierce
34-13232-21
21 cm/8¼"



Pennington
34-13236-21
21 cm/8¼"

Raspatories



34-13240-18
18 cm/7"



**Joseph (Cottle)
Masing**
34-13244-22
22 cm/8¾"



Masing
34-13248-20
20.5 cm/8⅜"



Joseph
34-13252-16
16cm/6¼"

Period-Elevators



Freer
34-13256-16
16 cm/6¼"



Freer
34-13260-16
16 cm/6¼"



Freer
34-13264-15
15 cm/6"



Ballenger
34-13268-04 4 mm
34-13268-06 6 mm
34-13268-08 8 mm
16 cm/6¼"



Killian
34-13272-16
16 cm/6¼"



Killian-Claus
34-13276-16
16 cm/6¼"

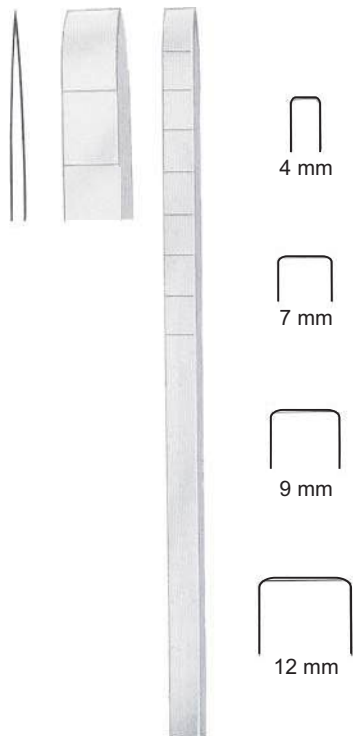

Cottle
34-13280-04 4 mm
34-13280-07 7 mm
34-13280-09 9 mm
34-13280-12 12 mm
18 cm/7"

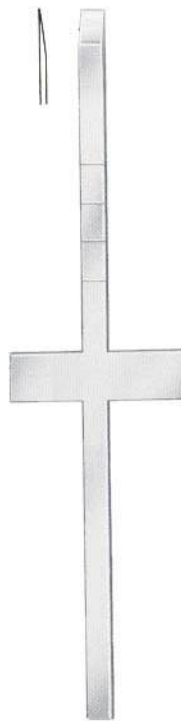

Cottle
34-13284-04 4 mm
34-13284-07 7 mm
34-13284-09 9 mm
34-13284-12 12 mm
18 cm/7"



Cottle
34-13288-18
18 cm/7"

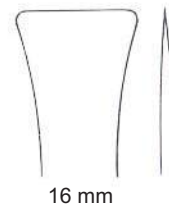

Cottle
34-13290-18
18 cm/7"



34-13294-08
16 cm/6¼"
8 mm



Cottle
34-13298-04 4 mm
34-13298-07 7 mm
34-13298-09 9 mm
34-13298-12 12 mm
18 cm/7"



Cottle
Curved
34-13299-06
18 cm/7"
6 mm



Fomon
34-13302-05 5mm
34-13302-08 8mm
17 cm/6¾"



Walter
34-13306-03 3 mm
34-13306-04 4 mm
18 cm/7"



34-13310-01



(Silver)
Masing
34-13310-02
17.5 cm/7⅞"



34-13310-03



Cinelli
34-13314-10 10 mm
34-13314-12 12 mm
34-13314-14 14 mm
34-13314-16 16 mm
16 cm/6¼"

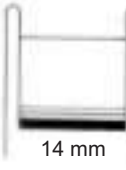

Masing
34-13318-17
17.5 cm/6⅞"



West
34-13322-16
16 cm/6¼"



West
34-13324-16
16 cm/6¼"

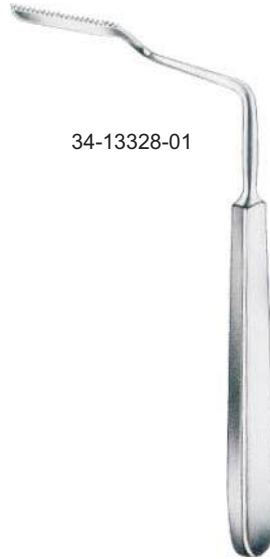

34-13328-01

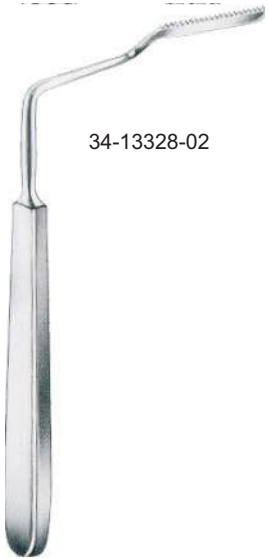

34-13328-02

Joseph
17 cm/6¾"



Joseph
34-13330-01
17 cm/6¾"



Joseph
34-13332-02
17 cm/6¾"



Joseph
34-13332-03
17 cm/6¾"

PinsmedTc



Fig.1



Fig.3



Fig.5



Fig.7



Fig.9



Fig.2



Fig.4



Fig.6



Fig.8

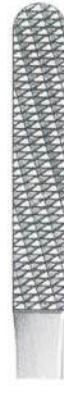

Fig.10

Fomon

- Fig. 1/ 2 34-13336-12
 - Fig. 3/ 4 34-13336-34
 - Fig. 5/ 6 34-13336-56
 - Fig. 7/ 8 34-13336-78
 - Fig. 9/10 34-13336-90
- 21 cm/8¼"

PinsmedTc



Parkes

- Fig. 1 34-13340-01
 - Fig. 2 34-13340-02
 - Fig. 3 34-13340-03
 - Fig. 4 34-13340-04
 - Fig. 5 34-13340-05
 - Fig. 6 34-13340-06
 - Fig. 7 34-13340-07
 - Fig. 8 34-13340-08
 - Fig. 9 34-13340-09
 - Fig.10 34-13340-10
- 20.5 cm/8¾"

Maltz

- Fig. 1 34-13344-01
 - Fig. 2 34-13344-02
 - Fig. 3 34-13344-03
 - Fig. 4 34-13344-04
 - Fig. 5 34-13344-05
 - Fig. 6 34-13344-06
 - Fig. 7 34-13344-07
 - Fig. 8 34-13344-08
 - Fig. 9 34-13344-09
 - Fig.10 34-13344-10
- 17 cm/6¾"



Maltz
17 cm/6¾"

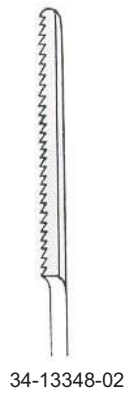

PinsmedTC



Miller
16 cm/6¼"

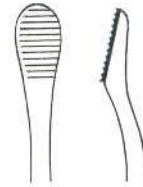

34-13352-01

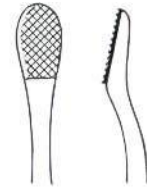

34-13352-02

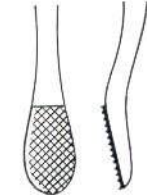
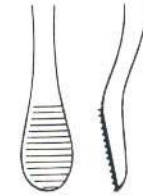

19 cm/7½"



Aufricht
34-13360-17
17.5 cm/6⅞"



Fomon
34-13364-21
21 cm/8¼"



Maltz
34-13368-18
18 cm/7"



Joseph
16 cm/6¼"

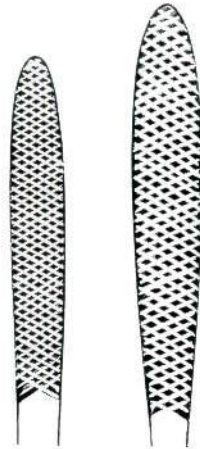

34-13372-01 34-13372-02



Lewis
18 cm/7"



Fine
34-13376-01



Coarse
34-13376-02



Cottle
34-13380-21
21 cm/8¼"



Aufricht
21 cm/8¼"

34-13384-01

34-13384-02



Joseph
34-13388-16
15 cm/6"



Cottle
34-13392-16
15 cm/6 1/4"



Lange
34-13396-22
22 cm/8 3/4"



Fomon
34-13400-17
17 cm/6 3/4"



Freer
34-13404-15
15 cm/6"



Frazier
34-13408-13 13 cm/5"
34-13408-18 18 cm/7"



Joseph
16 cm/6 1/4"



34-13412-02
2 mm



34-13412-05
5 mm



34-13412-07
7 mm



34-13412-10
10 mm



Fomon
34-13416-16
16 cm/6 1/4"



Neivert (Masing)
34-13420-20
20 cm/8"



Cottle-Neivert
34-13424-20
20 cm/8"

Hooks



Fomon
34-13428-14
14.5 cm/5 3/4"



Cottle
34-13432-14
14.5 cm/5 3/4"



Cottle
34-13434-14
14.5 cm/5 3/4"



Cottle
34-13436-14
14.5 cm/5 3/4"



Cottle
34-13440-16
15 cm/6"



Kilner
34-13444-08
8 cm/3 1/8"
10 mm

Columella Forceps



Converse
34-13448-12
12 cm/4 3/4"



Cottle
34-13456-10
10 cm/4"

Tissue Lifter



34-13460-14
14 cm/5 1/2"

Tissue Picks



34-13464-11
11 cm/4 3/8"



1.0 mm 34-13468-10
1.8 mm 34-13468-18



Walsham
23 cm/9"



34-13472-01



34-13472-02



34-13472-03



Cottle-Walsham
34-13474-22
22 cm/8 3/4"



Asch
34-13476-23
23 cm/9"



Kressner
34-13480-20
20 cm/8"



Rubin
34-13484-20
20 cm/8"



Faulkner
34-13488-21
21 cm/8¼"



Sewall
34-13492-20
20 cm/8"
6 mm



Coakley
17 cm/6¾"



34-13496-01 34-13496-02 34-13496-03



34-13496-04 34-13496-05 34-13496-06

Ringmesser



Beckmann
22 cm/8¾"

34-13500-01

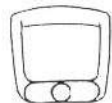

34-13501-01

34-13500-02

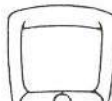

34-13501-02

34-13500-03



34-13501-03

34-13500-04



34-13501-04

34-13500-05



34-13501-05

34-13500-06

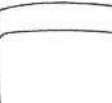

34-13501-06

Adenoid Curettes



Negus
20 cm/8"

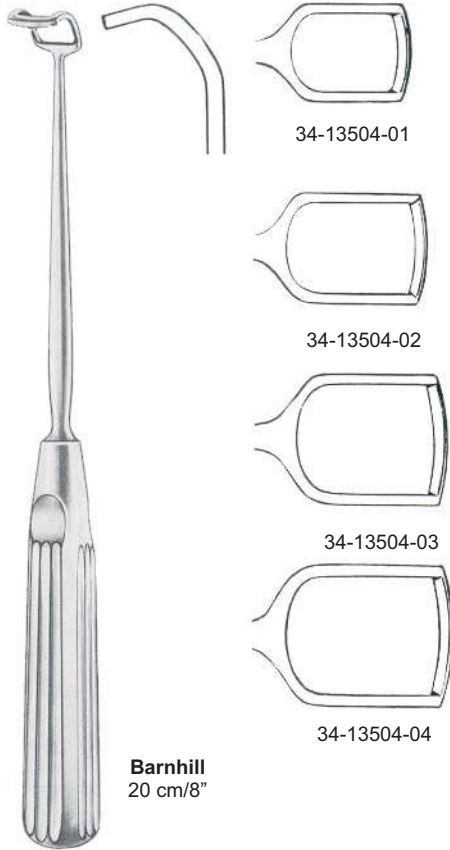

Barnhill
20 cm/8"

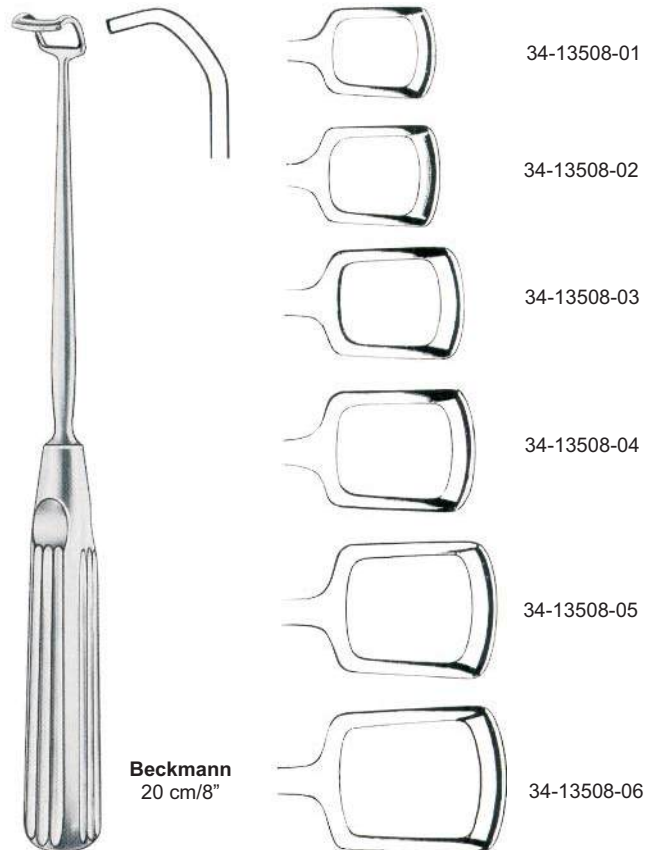

Beckmann
20 cm/8"



St. Clair-Thompson
22 cm/8 3/4"

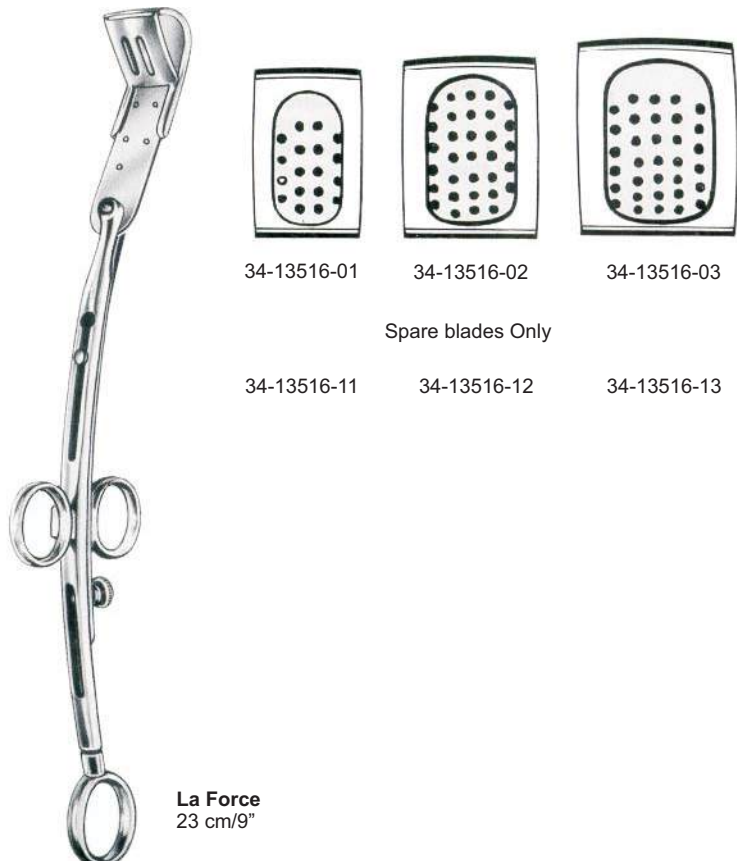

La Force
23 cm/9"



Bruenings- Brunk
34-13520-19
19 cm/7½"



Siebenmann



mm Ø

34-13524-15	1.5	34-13526-15
34-13524-17	1.7	34-13526-17
34-13524-20	2.0	34-13526-20
34-13524-25	2.5	34-13526-25
34-13524-30	3.0	34-13526-30



Fig. 1

Hartmann



Fig. 2

34-13530-20	34-13534-20
34-13530-25	34-13534-25
34-13530-30	34-13534-30



Eicken - Killian
34-13538-03
3 mm Ø



Killian
34-13538-15
1.5 mm Ø



Ritter - Halle
2.5 mm 34-13540-25
3.0 mm 34-13540-30
4.0 mm 34-13540-40

Gag Only
35-13546-10



Fig. 1
35-13546-01
65 x 28 mm

Kilner-Doughty
Complete
35-13546-00



Fig. 3
35-13546-03
80 x 37 mm

Fig. 2
35-13546-02
75 x 32 mm

Gag Only
35-13550-10

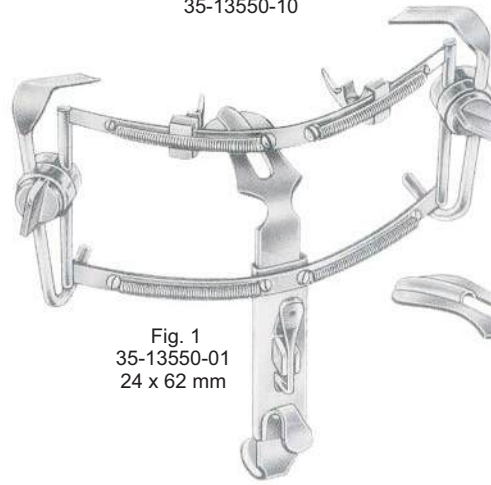

Fig. 1
35-13550-01
24 x 62 mm

Dingmann
Complete
35-13550-00



Fig. 3
35-13550-03
31 x 75 mm

Fig. 2
35-13550-02
28 x 65 mm

Gag Only
35-13554-10



Fig. 1
35-13554-01
21 x 26 mm

Davis-Boyle
Complete
35-13554-00



Fig. 2
35-13554-02
23 x 65 mm

Fig. 3
35-13554-03
24 x 80 mm

Fig. 4
35-13554-04
25 x 93 mm

Fig. 5
35-13554-05
26 x 108 mm

Gag Only
35-13558-10



Fig. 1
35-13558-01
23 x 70 mm

Mc Ivor
Complete
35-13558-00



Fig. 2
35-13558-02
25 x 86 mm

Fig. 3
35-13558-03
26 x 100 mm



Fig.		mm
2	35-13562-02	23 x 65
3	35-13562-03	24 x 80
4	35-13562-04	25 x 93
5	35-13562-05	26 x 108

Modell Wurzburg

Fig.		mm
1	35-13566-01	28 x 66
2	35-13566-02	32 x 75
3	35-13566-03	34 x 83
4	35-13566-04	37 x 93
5	35-13566-05	38 x 100



Chest Support for
Mouth gag
35-13570-00



Mouth Gags

Baby-Molt
35-13574-10
10 cm/4"

Molt
35-13576-11 11 cm/4¼"
35-13576-14 14 cm/5½"

Roser-Konig
35-13580-16 16 cm/6¼"
35-13580-19 19 cm/7½"

Denhart
35-13584-12
12 cm/4¾"

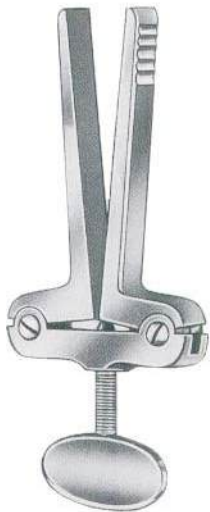

Heister
35-13588-13
13 cm/5"

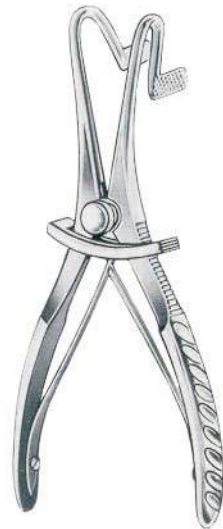

Fergusson-Ackland
35-13592-18 18 cm/7"
35-13592-20 20 cm/8"

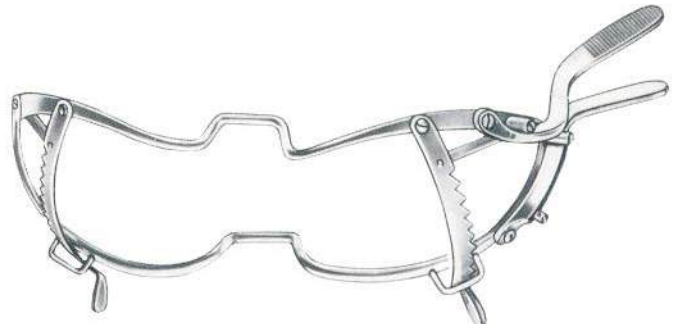

Whitehead
35-13596-11 11 cm/4¼"
35-13596-13 13 cm/5"
35-13596-15 15 cm/6"

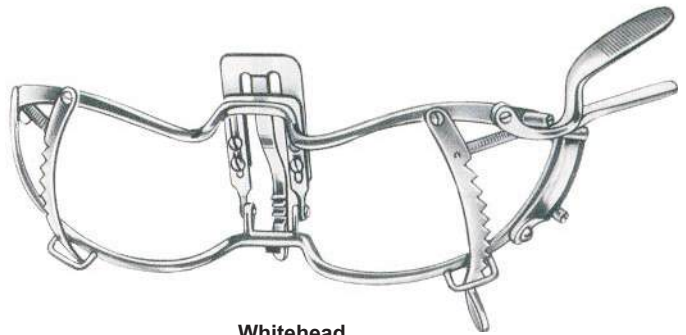

Whitehead
35-13600-13
13 cm/5"



Jennings
35-13604-09 09 cm/3½"
35-13604-11 11 cm/4¼"
35-13604-13 13 cm/5"
35-13604-15 15 cm/6"



Sternberg
35-13608-12 12 cm/4¾"
35-13608-14 14 cm/5½"
35-13608-16 16 cm/6¼"



35-13612-19
19 cm/7½"



Moritz-Schmidt
35-13616-19
19 cm/7½"



Hartmann
35-13620-15
15 cm/6"



Tobold
35-13624-14
14.5 cm/5¾"



Fraenkel
35-13628-19
19 cm/7½"



Frenzel
35-13632-16
16.5 cm/6½"



35-13636-13
13 cm/5"



35-13640-14
14.5 cm/5¾"



35-13646-14
14.5 cm/5¾"



Kroenig
35-13650-15
15 cm/6"



Mayo
35-13654-17
17 cm/6¾"



Bruenings
35-13658-19
19 cm/7½"



Bruenings
35-13662-19
19 cm/7½"



35-13666-01

35-13666-02

Wieder



Collin
35-13670-16
16 cm/6¼"



Collin
35-13672-19
19 cm/7½"



35-13676-19
19 cm/7½"



Young
35-13680-17
17 cm/6¾"



Guys
35-13682-19
19 cm/7½"

Finger Protectors



Lengenbeck
35-13684-01 Ø 22.0 mm
35-13684-02 Ø 24.5 mm
35-13684-03 Ø 26.5 mm

2.5 mm

1.8 mm

Gauze Packers

Luniatschek
36-13688-18
18 cm/7"

Luniatschek
36-13690-18
18 cm/7"

Trelat
36-13694-23
23 cm/9"

Claus
36-13698-23
23 cm/9"

Hurd
36-13702-24
24 cm/9½"

Hurd
36-13704-21
21 cm/8¼"

Ligature Carrier

Nager
36-13708-24
24 cm/9½"

Falk
36-13712-24
24 cm/9½"

Falk
36-13716-24
24 cm/9½"

Claus-Eicken
36-13720-23
23 cm/9"

Roeder
36-13724-26
26 cm/10¼"



36-13728-17
17.5 cm/6⁷/₈"



Fischer
36-13732-22
22.5 cm/8⁷/₈"



Douglas
36-13736-21
21 cm/8¹/₄"



Abraham
36-13740-21
21 cm/8¹/₄"



Bruenings
36-13744-23
23 cm/9"



Abraham
36-13748-19
19 cm/7¹/₂"



Canfield
36-13752-21
21 cm/8¹/₄"



Hurd
36-13756-22
22.5 cm/8⁷/₈"



Yankauer
36-13760-21
21 cm/8¹/₄"



Luniatschek
36-13764-19
19 cm/7¹/₂"



Henke
23 cm/9"



36-13768-01



36-13768-02



Nager
36-13772-23
23 cm/9"

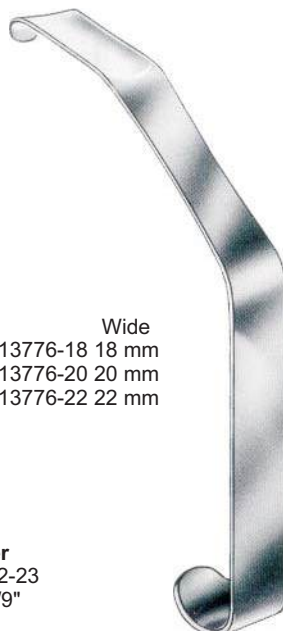

Wide
36-13776-18 18 mm
36-13776-20 20 mm
36-13776-22 22 mm



Love
23 cm/9"



Haslinger
36-13780-16

Hofer
36-13784-24
24 cm/9¹/₂"

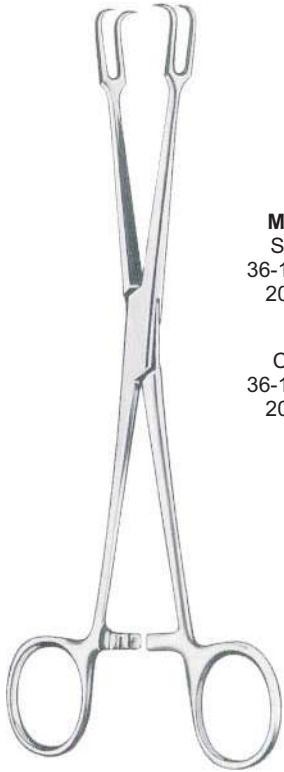

Museux
Straight
36-13788-20
20 cm/8"

Curved
36-13789-20
20 cm/8"



Ballenger
36-13792-21
21.5 cm/8½"



White
36-13796-18 18 cm/7"
36-13796-23 23 cm/9"



Marschik Kroni
36-13800-20
20.5 cm/8"



Colver
Straight
36-13804-19
19 cm/7½"

Curved
36-13805-19
19 cm/7½"



Blohmke
36-13808-20
20 cm/8"



Eves
36-13812-28
28 cm/11"



Eves
36-13814-28
28 cm/11"



Bruenings
36-13818-28
28 cm/11"



With 1 Straight Tip

Brown
36-13822-00



With 1 Straight Tip

Tyding
36-13826-00



Sluder-Ballenger
Complete, With 3 Tips
36-13830-00

Tonsil Punch Forceps



36-13834-13 13 mm Ø
36-13834-15 15 mm Ø
36-13834-17 17 mm Ø









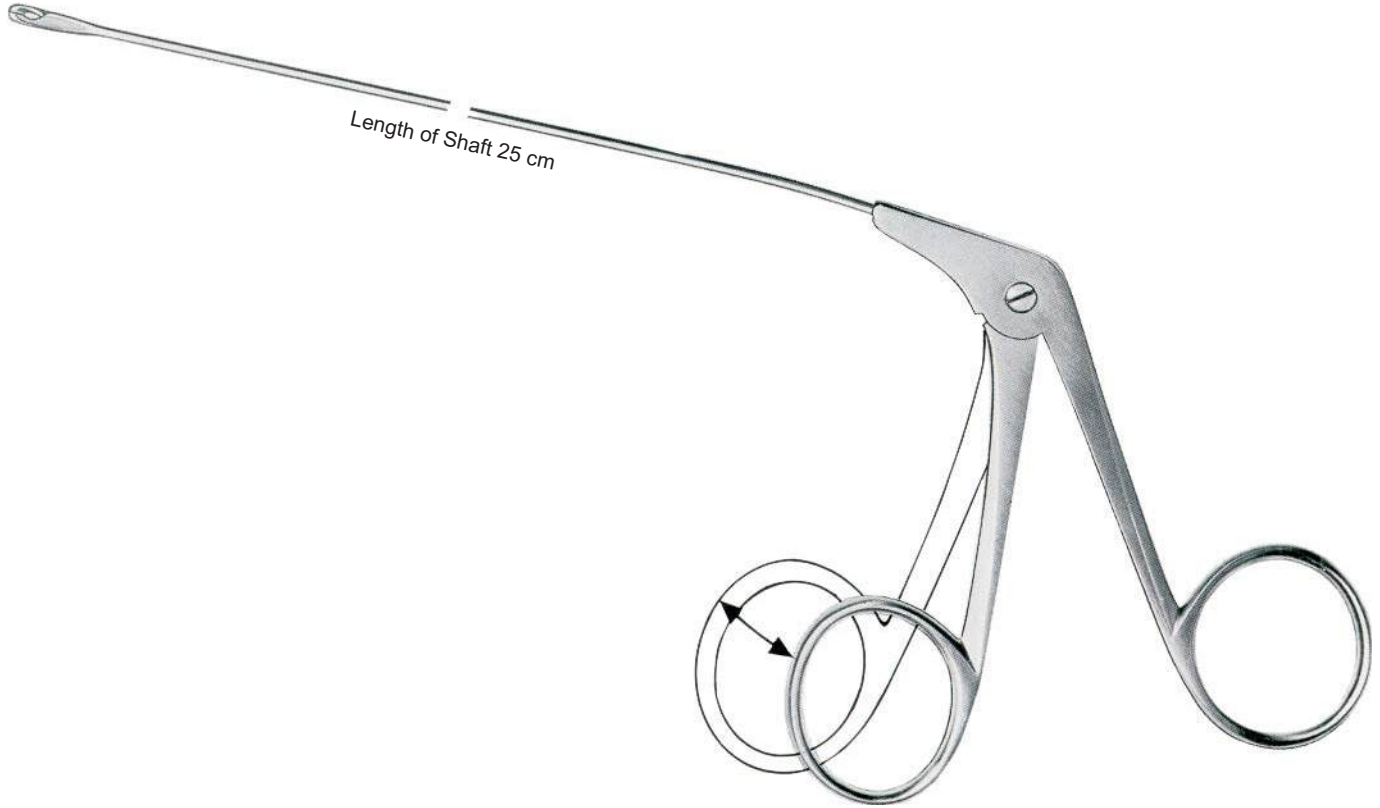







Hartmann

Tonsil Haemostats











































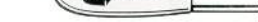







Corwin
36-13838-14
14 cm/5½"



	Micro Scissors	Micro Forceps	Cup Shaped Forceps 2.5 mm Ø
Straight	 37-13842-01	 37-13844-01	 37-13846-01
Straight Horizontal	 37-13842-02	 37-13844-02	
Angled Up	 37-13842-03		 37-13846-03
Angled Up Horizontal	 37-13842-04	 37-13844-04	 37-13846-04
Curved Right	 37-13842-05	 37-13844-05	 37-13846-05
Curved Left	 37-13842-06	 37-13844-06	 37-13846-06
			 Oval 37-13846-07



Length of Shaft

Length of Shaft For Children	40 cm	50 cm	60 cm
 35 cm 37-13850-01	 40 cm 37-13852-01	 50 cm 37-13854-01	 60 cm 37-13856-01
 37-13850-02	 37-13852-02	 37-13854-02	 37-13856-02
 37-13850-03	 37-13852-03	 37-13854-03	 37-13856-03
 37-13850-04	 37-13852-04	 37-13854-04	 37-13856-04
 37-13850-05	 37-13852-05	 37-13854-05	 37-13856-05
 37-13850-06	 37-13852-06	 37-13854-06	 37-13856-06
 37-13850-07	 37-13852-07	 37-13854-07	 37-13856-07
 37-13850-08	 37-13852-08	 37-13854-08	 37-13856-08
 37-13850-09	 37-13852-09	 37-13854-09	 37-13856-09
 37-13850-10	 37-13852-10	 37-13854-10	 37-13856-10
 37-13850-11	 37-13852-11	 37-13854-11	 37-13856-11
	 37-13852-12	 37-13854-12	 37-13856-12
	 37-13852-13	 37-13854-13	 37-13856-13

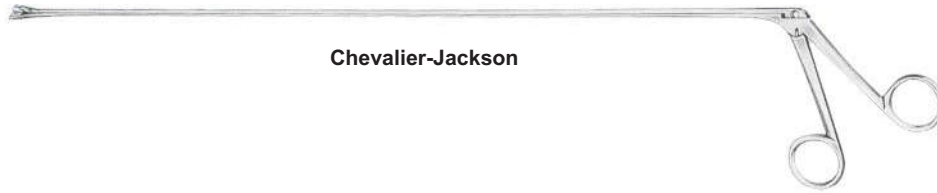

Length
cm in

30	12	37-13860-30	37-13862-30	37-13864-30	37-13866-30	37-13868-30	37-13870-30	37-13872-30	37-13874-30
40	16	37-13860-40	37-13862-40	37-13864-40	37-13866-40	37-13868-40	37-13870-40	37-13872-40	37-13874-40
50	20	37-13860-50	37-13862-50	37-13864-50	37-13866-50	37-13868-50	37-13870-50	37-13872-50	37-13874-50
60	24	37-13860-60	37-13862-60	37-13864-60	37-13866-60	37-13868-60	37-13870-60	37-13872-60	37-13874-60

Interchangeable Tips

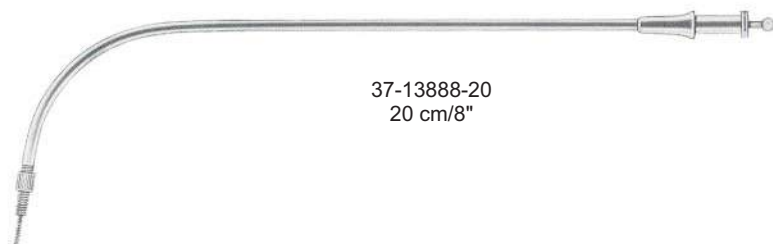

Straight	Lengths		Angular
	cm	in	
37-13884-20	20	08	37-13885-20
37-13884-30	30	12	37-13885-30
37-13884-40	40	16	37-13885-40
37-13884-50	50	20	37-13885-50
37-13884-60	60	24	37-13885-60



Baracani
37-13890-01



Seiffert
37-13892-01



Frankel
37-13894-01



Scheinmann
37-13896-01



Scheinmann
37-13896-02



Bruenings
37-13898-01 2 mm Ø
37-13898-02 3 mm Ø



Bruenings
37-13898-03



Bruenings
37-13898-04



Lange
37-13900-01



Krause
37-13902-01



Krause
37-13904-01



Cordes
37-13906-01



Schumacher
37-13908-01



Cordes



37-13910-01



37-13910-02



Flatau
37-13912-01



Fraenkel
37-13914-01



Metal Handles



Fig.	mm Ø
000	06
00	08
0	10
1	12
2	14
3	16
4	18
5	20
6	22
7	24
8	26
9	28
10	30

37-13916-06
37-13916-08
37-13916-10
37-13916-12
37-13916-14
37-13916-16
37-13916-18
37-13916-20
37-13916-22
37-13916-24
37-13916-26
37-13916-28
37-13916-30

37-13918-06
37-13918-08
37-13918-10
37-13918-12
37-13918-14
37-13918-16
37-13918-18
37-13918-20
37-13918-22
37-13918-24
37-13918-26
37-13918-28
37-13918-30

Michel

37-13920-10
37-13920-12
37-13920-14
37-13920-16
37-13920-18
25 cm/10"

37-13924-01



Fraenkel
37-13928-18
18 cm/7"

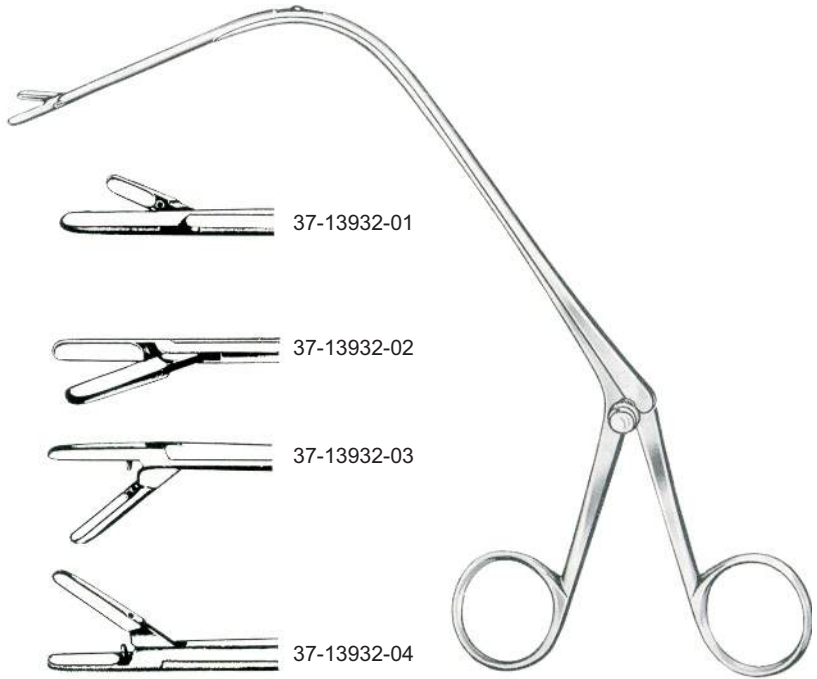

Jurasz
23 cm/9"

37-13932-01

37-13932-02

37-13932-03

37-13932-04

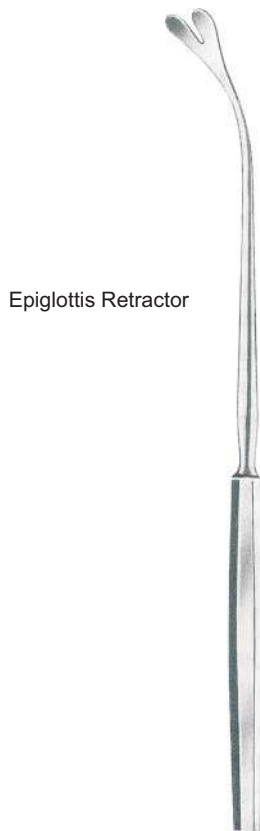

Epiglottis Retractor

Reichert
37-13936-24
24 cm/9½"



Killian
37-13940-20
20 cm/8"



Davis
38-13944-16 16 cm/6¼"
38-13944-24 24 cm/9½"

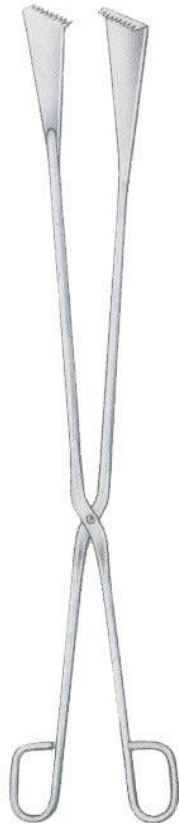

Sauerbruch
38-13948-55
55 cm/21½"



38-13952-20 20 cm/8"
38-13952-28 28 cm/11"
38-13952-30 30 cm/12"



Rogge
38-13956-23
23 cm/9"



Cheatle
38-13960-27
27 cm/10½"



Universal
38-13964-20 20 cm/8"
38-13964-28 28 cm/11"



Universal
38-13968-20
38-13968-28



Bunt
38-13972-01
10.5 cm/4¼"



Mayo
38-13972-02
14 cm/5½"

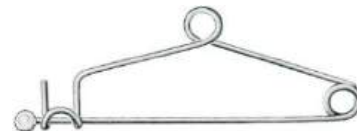

Mayo
38-13972-03
14 cm/5½"

Stainless

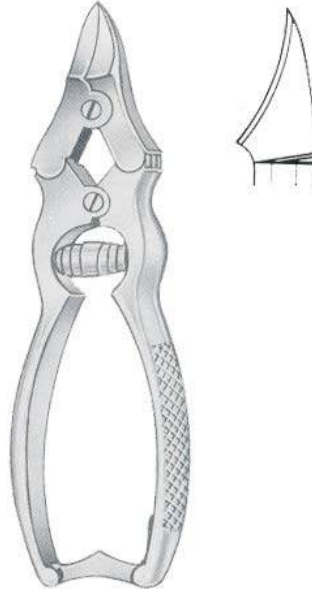

39-13976-15
15 cm/6"



39-13980-10
39-13981-10
10 cm/4"



Straight
Curved

39-13984-10
39-13985-10
10 cm/4"

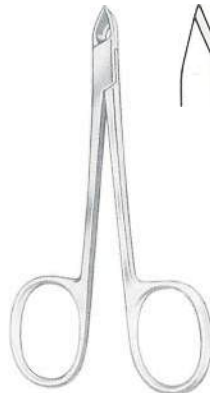

39-13992-10
10 cm/4"



39-13996-11
11 cm/4½"
39-13996-13
13 cm/5"



cm	in	
11	4½"	39-14000-11
13	5"	39-14000-13
14	5½"	39-14004-14
16	6¼"	39-14004-16



cm	in	
11	4½"	39-14012-11
13	5"	39-14012-13
14	5½"	39-14008-14
15	6"	39-14008-15
		39-14012-15

	Pages #		Pages #
A			
Abdominal and Intestinal Spatulas	180	Bulldog Clamps	424-426
Abdominal Retractors	197-202,204-209	Cardio Vascular Forceps	429,439-440,447
Abdominal Scissors	50	Cardid Clamps	448
Abortion Scoops	407	Coarction Clamps	427,443,449
ABRAHAM ,Tonsil Knives	621	Hemostatic Forceps	444
Adenoid,Curettes	612-613	Intestinal Tissue Forceps	332,334,336,338,342
Cutting Forceps	599	Ligature Clamps	446,452
ADLERKREUTZ ,Tissue Forceps	103	Multi Purpose Clamps	441,445,450
ADSON ,Atraumatic Tissue Forceps	111	Neontal Clamps	454-455
Bone Rongeur Forceps	302	Pediatric Clamps	453-454
Dressing Forceps	96	Protunda Clamps	446
Drill Guide Forceps	312	Tangential Occlusion Clamps	437
Hemostatic Forceps	124	Tissue Forceps	111,422-423
Ligature Forceps	109	AUFRIECHT ,Nasal Rasps TC	607
Needle Holders	232	Nasal Retractors	610
Nerve Retractors	523	Auricle Clamps	433
Periosteal Raspatories	276	AUSTIN ,Micro Forceps	8
Retractors	194-196	Autopsy Knives	28-29
Suction Tubes	10	AUVARD ,Vaginal Speculas	377
Tissue Forceps	102	Awls	312
ADSON-BABY ,Retractors	193	Awls for Maxillofacial Surgery	189
ADSON-BROWN ,Tissue Forceps	102	AXENFELD ,Chalazion Curettes,Double End	477
Advancement Forceps	490-491	Eye Hooks	473
AEBLI ,Iridectomy Scissors	67	AYER ,Cannulas	15
AGRICOLA ,Eye Specula	462	AYER .Chalazion Forceps	500
Airway Cannulas	14		
Alar Protectors	610		
ALDERDYCE ,Elevators	283	B	
ALEXANDER ,Bone Chisels	260	BABCOCK ,Intestinal Tissue Forceps	331
Bone Gouges	260	BABCOCK ,Intestinal Tissue Forceps TC	331
Cervical Biopsy and Specimen Forceps	396	BABCOCK-ATRAUMA ,Intestinal Tissue Forceps	331
Periosteal Raspatories	275	BABINSKY ,Percussion Hammers	3
ALLEN ,Intestinal Clamp Forceps	339	BABY-ADSON ,Hemostatic Forceps	124
ALLIS ,Intestinal Tissue Forceps	330	BABY-ALLIS ,Intestinal Tissue Forceps	330
ALLIS-ADAIR ,Intestinal Tissue Forceps	330	BABY-BABCOCK ,Intestinal Tissue Forceps	331
ALLIS-ATRAUMA ,Intestinal Tissue Forceps	330	BABY-BALFOUR ,Abdominal Retractors	203
ALLISON ,Lung Spatulas	420	BABY-COLLIN ,Intestinal Retractors	198
ALLPORT ,Retractors	190	BABY-COOLEY ,Rib Spreaders	415,418
ALM ,Retractors	190	BABY-CRILE ,Hemostatic Forceps	119
ALVIS ,Foreign Body Curettes	469	BABY-CRILE-WOOD ,Needle Holders TC	237
ALY ,Sensibility Instruments	1	BABY-DOYEN ,Intestinal Clamp Forceps	333
Amniotome for the Amnion Bladder	386	BABY-HEGEMANN ,Vascular Scissors	58
Amputation Knives	27	BABY-LEXER (KNAPP) ,Scissors	54
Amputation Saws	310	BABY-METZENBAUM ,Scissors,SuperCut	34
Anal Retractors	347	BABY-MIKULICZ ,Peritoneal Clamp Forceps	140
Anastomosis Clamp Forceps	428,438,442,446	BABY-MIXTER ,Dissecting and Ligature Forcep	132
ANDERSON-ADSON ,Retractors	194	BABY-MOLT ,Mouth Gags	616
ANDERSON-CRITCHETT ,Pterygium Knives	469	BABY-OLSEN-HEGAR ,Needle Holders With Scissors	232
ANDREW-PYNCHON ,Suction Tubes	11	Needle Holder with Scissors TC	243
ANEL ,LachrymalCannulas	481	BABY-OVERHOLT ,Dissecting and Ligature Forceps	128
Aneurysm Clamps	430-431,443	BABY-POOLE ,Suction Tube	12
Anterior Chamber Forceps	492	BABY-ROUX ,Retractors	180
Antrum and Frontal Sinus Wash Cannulas	614	BABY-SATINSKY ,Blood Vessel Clamps	422
Punch Forceps	598	BABY-SENN-MILLER ,Retractors	159
Anusopes	345-346	BABY-TROUSSEAU ,Trachea Dilators	325
Aortic Anastomosis Clamps	428,437-438,442,451	BACKHAUS ,Towel Forceps	142
Aortic Aneurysm Clamps	430-431,443	BACON ,Bone Rongeurs	300
Aortic Clamps	432,453-456	BAILEY ,Rib Contractors	420
Aortic Dilators	457	BAILEY-BABY ,Rib Contractors	420
Aphla Chymotrypsin Cannulas	482	BAILEY-GIBBONS ,Rib Contractors	420
Applying and Removing Forceps	508	BAINBRIDGE ,Atrauma Cardiovascula Forceps	430
Applying Forceps For Bulldog Clamps	115,149	Hemostatic Forceps	123
ARIT ,Lens Scoops	475	BAKE ,Gall Duct Probes	357
ARROWSWORTH ,Corneal Fixation Forceps	501	BALFOUR (USA PATT) ,Abdominal Retractors	206
ARRUGA ,Capsular Forceps	498-499	BALFOUR ,Abdominal Retractors	204-206
Extraction Hooks	471	BALLENGER ,Chisels	603
Eye Specula	460	Swivel Knives	600
Micro Needle Holders	226	Tonsil Forceps	623
Micro Needle Holders	242	BALLENTINE ,Hysterectomy Forceps	136
Protectors	472	Band Pushers	189
ARRUGA-NIZETIC ,Capsular Forceps	498	Bandage Scissors	87-89
Arteriotomy Scissors	60	BANE-HARTMANN ,Bone Rongeurs Forceps	299
ASCH ,Septum Forceps	611	BANGERTER ,Cyclodialysis Spatulas	481
Asepsis Instruments	633	BARACANI ,Tips	629
Atrauma,Anastomosis Forcep	428,437-438,442,451	BARBARA ,Micro Needles	579-580
Aortic Aneurysm Clamps	430-431,443	BARBARA ,Micro Hooks	579-580
Aortic Clamps	432,435-436	BARKEN ,Goniotomy Knives	469
Auricle Clamps	443		
Bronchus Clamps	434		

B	Pages #	Pages #
BARNES-NEVILLE ,Obstetrical Forceps	411	Holding Forceps 292-296
BARNHILL ,Adenoid Curettes	613	Instruments 258-324
BARON-SCHUKNECHT ,Suction Tubes	568	Lever 282-289
BARR ,Rectal Speculas	345	Osteotomes 258-263
BARRAQUER ,Anterior Chamber Forceps	492	Rasps 273
Cilia Forceps	110	Retractors 162-163
Eye Speculas	459	Rongeur Forceps 299-306
Fixation Forceps	504	Wires 319
Micro Needle Holders TC	227	Wire Guides 319
Micro Scissors	65	Wire Tighteners 319
Suture Forceps	488	BONN ,Eye Scissors 82
BARRAQUER-COLIBRI ,Eye Speculas	459	Iris Forceps 493
Iris Forceps	492,494	Iris Hooks 471
ARRAQUER-KATIN (COLIBRI) ,Fixation Forcep	497	Irrigating Cannulas 478
BARRETT ,Tenaculum Forceps	385	Lachrymal Cannulas 481
BARSKY ,Retractors	377	BONNEY ,Dressing Forceps 97
BARTH ,Bone Curettes	271,585	Tissue Forceps 106
Basiotribes	408	BORES , Corneal Fixation Forceps 501
BEACHAM ,Amniotome	386	Corneal Markers 487
BEAUPRE ,Cilia Forceps	109	Marking Instruments 487
BECK ,Anastomosis Clamps	451	BOSE ,Retractors 190,325
Atrauma Cardiovascular Forceps	438	Trachea Dilators 325
BECKER ,Cystotomes	470	Trachea Hooks 325
BECKMANN ,Adenoid Curettes	612-613	BOUCHERON ,Ear Speculas 565
Nasal Speculas	590	BOWDLER-HENRY'S ,Osteotomes, 188
BECKMANN-ADSON ,Retractors	195-196	BOWLES ,Stethoscopes 1
BECKMANN-EATON ,Retractors	197	BOWMANN ,Discission Knives 467
BEEBEE ,Crown Scissors	91	Discission Needles 469
BEER ,Cilia Forceps	110	Eye Speculas 459
BEESON ,Plaster Spreaders	256	Lachrymal Probes 484
BELLUCCI ,Micro Scissors	573,575	BOYNTON ,Needle Holders 226
BENGOLA ,Hemostatic Forceps	125	Needle Holders TC 242
BENNETT ,Bone Levers	289	BOYS-ALLIS ,Intestinal Tissue Forceps 330
Cilia Forceps	109	BOZEMANN ,Dressing Forceps 147
BENSAUDE ,Anuscopes	345	Loop Twisters 254
BENSON ,Pylorus Spreaders	339	Needle Holders 235
BERENS ,Keratomes	446	BOZEMANN-DOUGLAS ,Cotton Swab Forceps 148
Scleral Hooks	472	Brain,Knives 28
BERGER ,Cervical Biopsy and Specimen Forceps	394	Spatulas 520-521
BERGMAN ,Bandage Scissors	88	BRAND ,Tendon Seizing Instruments 122
Operating Knives	25	Tendon Strippers 322
Retractors	156	BRAUN ,Cranioclasts 408
BERKE ,Advancement Forceps	490	Decapitating Hooks 408
BERLINER ,Percussion Hammers	2	Tenaculum Forceps 385,387
BERNHARD ,Towel Forceps	143	Uterine Depressors 382
BETHUNE ,Rib Shears	412	Vaginal Speculas 373-374
BEYER ,Bone Rongeurs	301,303	BRAUN-STADLER ,Perineum Scissors 62
BILL ,Traction Handles	410	Perineum Scissors,SuperCut 37
BILLEAU ,Ear Loops	585	BREISKY ,Pelvimeters 405
BINKHORST ,Capsular Forceps	498	Vaginal Speculas 377
Irrigating Cannulas	478	BRIDGE ,Hemostatic Forceps 125
Biopsy,Forceps	393-398	BRISTOW ,Bone Levers 288
Aspirating Curettes	391-392,401	BRODIE ,Probes 210
BIRCHER ,Meniscotomy Knives	291	Broncho-Esophagoscopy Instruments 628-631
BIRCHER-GANSKE ,Bone Holding Forceps	293	Bronchus Forceps 127,421
BIRKETT ,Hemostatic Forceps	125	BROPHY ,Dressing Forceps 97
BISHOP ,Iris Forceps	493	Scissors 52
Bladder Retractors	361-363	Tissue Forceps 104
BLAKE(ZWEIFEL) ,Uterine Curettes	404	BROWN ,Needle Holders 229
BLAKE ,Gall Stone Forceps	356	Snare 624
BLASCOVICS ,Muscle Forceps	490	Tissue Forceps 103
Blindgut Forceps	339	BRUENINGS ,Septum Forceps 595
Blood Vessel Clamps	421-422	Septum Knives 584,600
BLOHMKE ,Tonsil Seizing Forceps	623	Tips 629
BLOUNT ,Bone Levers	289-290	Tongue Depressors 619
Meniscus Retractors	172	Tonsil Knives 621
BLUMENTHAL ,Bone Rongeurs Forceps	301	Tonsil Snare 624
BOETTCHER ,Tonsil Scissors	60	Universal Handles 626
BOHLER ,Bone Cutting Forceps	307	BRUENINGS-BRUNK ,Antrum Retractors 614
Bone Rongeur Forceps	303	BRUNETTI ,Chisels 31
Extension Bows	317	BRUNNER ,Intestinal Clamps Forceps 336
BONACCOLTO ,Suture Forceps	489	Ligature Conductors 251-252
Bone,Chisels	258-263	Ligature Needles 251
Curettes	265-272	Retractors 176
Cutting Forceps	307-308	Rib Shears 412
Files	273	BRUNNER-FERROZELL ,Conductors 251-252
Gouges	258-264	BRUNS ,Bandage Scissors 89
Hand Drills	311	Bone Curettes 266-267
Holding Clamps	298	BRYANT ,Cotton Swab Forceps 145

B

BUCK ,Ear Curettes	585
Foreign Body Levers	570
Percussion Hammers	2
BUCK-GRAMCKO ,Bone Levers	284
BUCKINGHAM ,Hand Instruments	582
BUELAU ,Trocars	7
BUIE ,Clamp Forceps	137
Probes	211
Rectal Aspiration Cannulas	349
Bulldog,Clamps	115,149
Atrauma	149
BUMM ,Uterine Curettes	404
BUNGE ,Exenteration Scoops	477
BUNT ,Waste Clamps	632
BURCH ,Fixation Hooks	469
BURKE ,Cervical Biopsy and Specimen Forceps	397
BURFORD ,Rib Spreaders	419
BUSCH ,Umbilical Scissors	62
BUSCHE ,Bone Curettes	270

C

Calipers	5
canaliculus Knives	467
CANFIELD ,Tonsil Knives	621
Cannulas	15, 478-482
CAPLAN ,Septum Forceps	597
Capsular Forceps	496-498
Capsule Polishing Instruments	480
Cardiovascular,Forceps	421-455
Instruments	412-458
CAROLL ,Goniometers	5
Tendon Seizing Instruments	324
Carotid Clamps	448-449
CARREL ,Hemostatic Forceps	115
Cartilage,Knives	29
Scissors	58
CASPER ,Lamina Spreader	510-511
Micro Dissectors	557-559
Retractors	169
CASTANEDA ,Neonatal Clamps	455
Rib Spreaders	418
CASTROVIEJO ,Calipers and Markers	483
Capsular Forceps	498
Cycloclodialysis Spatulas	474,485
Eye Knives	466
Eye Spatulas	474-475,485
Eye Speculas	462
Fixation Forceps	502-503
Iridectomy Scissors	67,69
Keratomes	466
Lachrymal Dilators	484
Micro Needle Holders	216-217,226
Micro Needle Holders TC	226,227
Razor Blade Breakers	30
Suture Forceps	502
CASTROVIEJO-BARRAQUER ,Eye Spatulas	474
CASTROVIEJO-KALT ,Micro Needle Holders	225
Cataract Knives	464
Spoons	425
Catheter,Forceps	14
Introducing Instruments	14
CATLIN ,Amputation Knives	27
Cephalotomy Scissors	50
Cervical,Biopsy and Specimen Forceps	395-398
Traction Tongs	507
CHADWICK ,Eye Scissors	83
Gum Scissors	94
Chalazion,Curettes	476
Curettes Double	477
Forceps	500
CHANDLER ,Bone Levers	289
Iris Forceps	496
CHAPUT ,Hemostatic Forceps	115
CHARRIERE ,Amputation Saws	310
CHEATLE ,Sterilizing Forceps	632
Cheek Retractors	182
CHERON ,Cotton Swab Forceps	147

Chest Support For Mouth Gags	616
CHEVALIER-JACKSON ,Broncho-Esophagoscopy Forceps	628
Trachea Tubes	326
CHILD ,Intestinal Clamp Forceps	332
Wound Suture Forceps	255
Chisels	258-264,603-605
Cilia Forceps	109-110
CINELLI ,Chisels	604
Circumcision Instruments	365
CITELLI ,Ear Punch	584
CITELLI-BEYER ,Ear Punch	584
Clamps	137-139
CLAUS ,Tonsil Needles	620
CLAUS-EICKEN ,Tonsil Needles	620
Cleft Palate Knives	621
CLEVELAND ,Bone Cutting Forceps	307
Bone Rongeur Forceps	307
Clip Applying Forceps	255
Clothing Scissors	90
CLOWARD ,Bone Chisels	259
Bone Gouges	259
Lamina Spreaders	512-513
Nerve Retractors	524
COAKLEY ,Curettes	612
Trocars	8
Coarctation Clamps	443-449
COBB ,Gouges	264
Periosteal Raspatories	271,281
COLCULUGH ,Rongeur Forceps	529
Collar Button Cannulas	482
COLLER-CRILE ,Hemostatic Forceps	120
COLLIER ,Needle Holders	229
COLLIN ,Abdominal Retractors	198-199
Clip Applying Forceps	255
Cotton Swab Forceps	147
Dynamometers	5
Hemostatic Forceps	116
Pelvimeters	405
Retractors	161
Rib Shears	90
Tongue Forceps	619
Umbilical Cord Clamps	408
Uterine Curettes	400
Uterine Elevating Forceps	389
Uterine Sounds	382
Vaginal Speculas	367
COLLIN-DUVAL ,Grasping Forceps	105
COLLIN-HARTMANN ,Retractors	160
COLLIN-LANDAU ,Vaginal Speculas	367
COLLIN-POZZI ,Tenculum Forceps	385
COLLYER ,Pelvimeters	405
Columella Forceps	610
COLVER ,Tonsil Seizing Forceps	623
Comedone Extractors	328
Conductors	506
CONE(ADSON-BABY) ,Retractors	193
CONE ,Knives	390
Retractors	194
Conjunctival Forceps	495
CONNEL ,Airways	14
CONNIN-AMSLER ,Marking Instruments	483
CONVERSE ,Needle Holders TC	237
Rhinoplastic Hooks	610
Rhinoplastic Knives	599
CONWAY ,Lid Retractors	463
COOK ,Eye Speculas	461
COOLY ,Anastomosis Clamps	451
Aortic Dilators	458
Atrauma Dissecting Forceps	424
Atrauma Pediatric Clamps	453
Carotid Clamps	448
Coarctation Clamps	449
Ligature Clamps	452
Multi Purpose Clamps	450
Retractors	181
Rib Shears	415,418
Suction Tubes	456
Vascular Dilators	457
COOLY-DERRA ,Atruma Cardiovascular Forceps	452

C			
COPPER ,Ligature Needles		248	
CORDES Tips		629	
CORWIN ,Tonsil Hemstatic Forceps		625	
Corneal,Dissectors		477	
Fixation Forceps		501	
Knives		468	
Scarifiers		468	
Coronary Scissors		55	
Cortex Aspirating Canuulas		480	
CORYLLOS ,Retractors		177	
COS ,Micro Forceps		573	
COTTLE ,Alar Protectors		610	
Chisels	603-604		
Columella Forceps		610	
Mallets		320	
Nasal Rasps		608	
Nasal Scissors		63	
Nasal Speculas		592	
Rhinoplastic Hooks	609-610		
Rhino Knives		600	
Scissors, SuperCut		37	
Septum Elevators	601-602		
COTTLE-NEIVERT ,Rhinoplastic Hooks		609	
COTTLE-WALSHAM ,Septum Straightening Forceps		611	
Cotton,Applicators		211-213	
Swab Forceps	145,147-148		
Cover Glass Forceps		110	
Gauze,Packers		620	
CRAFOORD ,Hemostatic Forceps		127	
Lobectomy Scissors		61	
GRAIG ,Septum Forceps		594	
CRAIG-DOMNICK ,Septum Forceps		594	
Cranioclasts		408	
CRAWFORD ,Retractors		172	
CRILE ,Hemostatic Forceps		119	
Needle Holders		233	
Retractors	150,157		
CRILE-BABY ,Hemostatic Forceps		119	
CRILE-MURRAY ,Needle Holders		233	
CRILE-RANKIN ,Hemostatic Forceps		11	
CRILE-WOOD ,Needle Holders		232	
Needle Holders TC		237	
CRITCHETT ,Eye Speculas		462	
Crown Scissors		91	
Crurotomy Forceps		576	
CRUTCHFIELD ,Bone Drills		507	
Cervical Traction Tonges		507	
CULLER ,Iris Spatulas		473	
Muscle Hooks		471	
CUSCO ,Vaginal Speculas		366	
CUSHING ,Brain Spatulas		520	
Decompression Hooks		158	
Dressing Forceps		99	
Laminectomy Rongeur Forceps	530-531		
Nerve Retractors		523	
Retractors	150,157-158		
Tissue Forceps		104	
CUSHING-LANDOLT ,Speculas		563	
CUSHING-KOCHER ,Retractors		158	
CUSHING-TAYOR ,Dressing Forceps		99	
Cyclodialyse,Spatulas	473-474		
Spoons		485	
Cystotome Cannulas		497	
Cystotomes		471	
CZERNY ,Gall Stone Forceps Forceps		356	
Rectal Speculas		344	
Tenaculum		386	
D			
DAHLGREN ,Cranial Forceps		506	
DANDY ,Hemostatic Forceps		122	
Nerve Retractors		524	
Scissors	64,84		
DARDIK ,Atrauma Cardiovascular Forceps		440	
DARTIGUES ,Uterine Elevating Forceps		389	
DASTOOR ,Erisiphakes		499	
DAUBENSPECK ,Bone Curettes		270	
DAVIDSON ,Retractors		181	
DAVIDSON-ALEXANDER ,Periosteal Raspatories		275	
DAVIEL ,Cataract Spoons		475	
DAVIS ,Dissectors		517	
Foreign Body Needles		470	
DAVIS-BOYLE ,Mouth Gags		615	
DAY ,Hooks		586	
DE-BAKEY ,Aortic Aneurysm Clamps		431	
Aortic Clamps		435	
Atrauma Bulldog Clamps		424	
Atrauma Cardiovascular Forceps	429,439,447		
Atrauma Tissue Forceps	422-423		
Carotid Clamps Forceps		426	
Dissecting and Ligature Forceps		428	
Ligature Clamps		435	
Multi Purpose Clamps	441,445		
Needle Holders		236	
Peripheral Clamps		439	
Retractors		201	
Rib Spreaders		416	
Vascular Forceps		458	
Vascular Scissors	55,58		
DE-BAKEY-BAHNSON ,Aorta Aneurysm Clamps		443	
DE-BAKEY-BAINBRIDGE ,Atrauma Cardiovascular Forceps		429	
DE-BAKEY-BECK ,Atrauma Cardiovascular Forceps		439	
DE-BAKEY-FNE ,Needle Holders TC		236	
DE-BAKEY- MOSQUITIO ,Atruma Hemostatic Forceps		444	
DE-BAKEY-PEAN ,Atrauma Hemostatic Forceps		444	
DE-BAKEY-RANKIN ,Atrauma Hemostatic Forceps		445	
DE-BAKEY-SATINSKY ,Bulldog Clamps	425-426		
DE-BAKEY-SEMB ,Ligature Clamps		436	
DE LEE ,Obstetrical Forceps		410	
Pelvimeters		405	
DE VILLBISS ,Cranial Forceps		506	
DEAN ,Eye Knives		468	
Gum Scissors		93	
DEAVER ,Retractors		178	
Retractors Handles		178	
Scissors		40	
Decapitating Hooks		408	
DECKER ,Micro Scissors		540	
DEJERINE ,Percussion Hammers		2	
DEMEL ,Bone Wire Guides		319	
DENHART ,Mouth Gags		616	
DENIS-BROWN ,Abdominal Retractors		208	
DERF ,Needle Holders		229	
Needle Holders TC		235	
Dermatology Instruments	328-329		
DERRA-DE BAKAY ,Atrauma Cardiovascular Forceps		446	
DESCHAMPS ,Ligature Needles	241-246		
DESJARDINS ,Gall Duct and Cystic Forceps		355	
Gall Stone Forceps		356	
Gall Stone Probes		357	
Gall Stone Scoops		358	
DESMARRES ,Chalazion Forceps		500	
Corneal Knives		468	
Lid Retractors		463	
Retracotrs		157	
DIEFFENBACH ,Bulldog Clamps		115	
Operating Knives	24-25		
DIETER ,Micro Forceps		573	
DIETRICH ,Aortic Clamps		432	
Bulldog Clamps		149	
Micro Needle Holders TC		228	
Dilating Bougies		363	
DINGMAN ,Bone Holding Forceps		292	
Raspatories		187	
Retractors		186	
Wire Guides		186	
DINGMANN ,Mouth Gags		615	
Directors,With Tongue Tie		210	
With Probes		210	
Discision Needles		469	
Dissecting and Ligature Forceps	124,128-134		
Dissecting,Knives		22	
Scissors	43-48,55,60,64,84		
Dissecting Sets		33	
Dissectors	517-519,552-553		
DITTAL ,Dilating Bougies		363	
DIX ,Double-Ended Instruments		485	

D	Pages #	F	Pages #
Foreign Body Instruments	470	Episiotomy, Scissors	62
DIXON-LOVELACE , Hemostatic Forceps	123	EPENDDORF , Cervical Biopsy and Specimen Forceps	396
DOCKHORN , Cheek Retractors	182	EPSTEIN , Bone Curettes	272
Double, Fixation Forceps	472	ERHARDT , Ear Speculas	564
Ended Instruments	485-486	Entropium Forceps	491
DOUAY , Cervical Biopsy and Specimen Forceps	395	Erisiphakes	499
DOUGLAS , Cilia Forceps	110	ERMOLD , Needle Holders	232
Tonsil Knives	621	ESMARCH , Bandage Scissors	88
Trocars	8	Plaster Knives	256
DOYEN , Abdominal Retractors	209	Eustachin Catheters	568
Gynaecological Scissors	50	EVES , Tonsil Snare	624
Intestinal Clamp Forceps	333	EWALD , Dressing Forceps	96
Myoma Screws	390	Tissue Forceps	102
Ovarian Forceps	389	Exenteration Scoops	477
Periosteal Raspatories	278	Extension Bows	317-318
Retractors	175	Extirpation Chisels	470
Towel Forceps	143	Eye, Cannulas	478-482
Vaginal Speculas	375-376	Extraction Hooks	471-472
DOYEN-ATRAUMA , Intestinal Clamp Forceps	334	Hooks	471-472
DOYEN-STILLE , Retractors	175	Instruments	458-505
Dressing Forceps	95-99	Knives	464-466, 469
Drill Guide and Dura Protecting Forceps	312	Knives Lanced Form	467
DUAL , Stethoscopes	1	Ligature Needles	505
DUBOIS , Gynecological Scissors	50	Muscle Hooks	473
DUNCAN , Biopsy Curettes	392	Protectors	473
DUPLAY , Polypus and Dressing Forceps	146	Scalpels	464
Tenaculum Forceps	385	Scissors	80-82
DUPUY-WEISS , Ligature Needles	247	Spatulas	474
Dura, Dissectors	517-519	Speculas	459-462
Elevators	517-519		
Scissors	84		
DURANTE , Tissue Forceps	105	FAGER , Dissectors	518
DURHAM , Ligature Needles	247	FAHLBUSCH , Curettes	562
DUVAL , Intestinal Tissue Forceps	332	Pituitary Instruments	562
Tissue Forceps	105	FALK , Tonsil Needles	620
Dynamometers	5	FARABEUF , Bone Holding Forceps	296
		Periosteal Raspatories	279
		Retractors	161
		FARABEUF-COLLIN , Periosteal Raspatories	279
		FARABEUF-LAMBOTTE , Bone Holding Forceps	297
		FARREL , Cotton Applicators	212
		FAULKNER , Curettes	612
		FAURE , Cervical Biopsy and Specimen Forceps	394
		Clamp Forceps	139
		Hysterectomy Forceps	140
		FAVALORO , Vascular Scissors	55
		FEHLAND , Intestinal Clamp Forceps	336
		FEILCHENFELD , Splinter Forceps	108
		FEIN , Cotton Applicators	211
		FERGUSON , Bone Holding Forceps	293
		Gall Stone Scoops	359
		Haemorrhoidal Clamps	136
		Uterine Scissors	42
		Suction Tubes	9
		FERGUSON-ACKLAND , Mouth Gags	617
		FERRIS-SMITH , Rongeurs	532
		Septum Forceps	595
		Tissue Forceps	105
		FERRIS-SMITH-KERRISON , Antrum Punch	598
		Rongeurs	526-527
		Fine, Forceps	107
		Operating Scissors	51-54
		Scissors	51-54
		Scissors, SuperCut	35
		Finger, Goniometers	5
		Protectors	619
		Ring Cutters	309
		FINK , Eye Hooks	471
		FINOCCHIETTO , Gall Duct Clamps	133
		Lobectomy Scissors	61
		Needle Holders	231
		Needle Holders TC	239
		Rib Spreaders	413, 419
		FINOCCHIETTO-BABY , Rib Spreaders	413
		FINOCCHIETTO-BABY-HAIGHT , Rib Spreaders	418
		FINOCCHIETTO, BURFORD , Rib Spreader	413
		FINSEN , Retractors	190
		FINSTERER , Suction and Irrigation Cannulas	12

	Pages #		Pages #
FISCH ,Crurotomy Forceps	576	Tubing	144
Micro Dissectors	581	Twin Clamps	341,343
FISCHER ,Iris Forceps	496	Vaginal	138-139
Tonsil Knives	621	Watchmarkers	106,504
Tendon Strippers	322	FORD ,Stethoscopes	1
FISCHER-ARIT ,Iris Forceps	496	FORD-DIXON ,Haemorrhidal Ligators	351
FISH ,Probes	210	Foreign,Body Chisels	470
Fistula,Hooks	390	Body Curettes	476-477
Knives	26	Body Lever Instruments	586
Probes	211	Body Forceps	365
Scissors	50	Body Gouges	485-486
Fixation,Discs For Extension Bows	318	Needles	485-486
Discs for Wires Drills	318	FOREGGER ,Laryngoscopes	18
Forceps	496-497	FORSTER ,Swab Holding Forceps	148
Forks	469	FOX ,Lupus Curettes	329
Flap,Knives	27	FRAENKEL ,Laryngeal Polypus Forceps	631
FLATAU ,Tips	629	Nasal Speculas	589
FOERSTER ,Iris Forceps	494	Tips	629
Sponge Holding Forceps	146	Tongue Deressors	618
FOMON ,Chisels	604	FRANCIS ,Foreign Body Needles	469
Nasal Rasps TC	606-607	FRANKFELDT ,Cotton Applicators	213
Nasal Scissors	63	FRANZ ,Abdominal Retractors	209
Nasal Scissors,SuperCut	37	FRAZIER ,Abdominal Retractors	202
Retractors	610	Elevators	517
Rhinoplastic Hooks	609-610	Hooks	609
Forceps,Advancements	490-491	Nerve Retractors	525
Anastomosis Clamps	428,438,442,446	Retractors	150
Aneurysm Clamps	430-431,443	Suction Tubes	9-10
Anterior Chamber	492	FREER ,Chisels	602
Aortic	432,453-456	Rhinoplastic Hooks	609
Atrauma	111-423	Rhinoplastic Knives	600
Auricle	433	Septum Elevators	601
Blindgut	339	FREER-YASARGIL ,Septum Elevators	601
Blood Vessel	421-422	FRIEDMANN ,Bone Rongeur Forceps	299
Bronchus	127,421	FRIEDMANN-DELICATE ,Bone Rongeur Forceps	300
Bulldog	115,149	FRITSCH ,Retractors	175
Capsular	496-498	FRYKHOLM ,Bone Rongeur Forceps	306
Cardiovascular	421-455	FUCHS ,Capsular Forceps	498
Chalazion	500	Iris Forceps	496
Cilia	109-110	FUCHSIG ,Hemostatic Forceps	123
Clip Applying	255		
Coarctation	443,449	G	
Conjunctival	495	Gall,Duct and Cystic Forceps	355
Cover Glass	110	Duct Clamp Forceps	133-134,137
Dissecting and Ligature	124,128,134	Duct Duct Forceps	355
Dressing	95-99	Duct Stone Forceps	356
Ear	111,568	Duct Stone Probes	357
Entropium	491	Duct Stone Scoops	358-359
Fine	107	GARDNER ,Mallet	321
Fixation	496-497	GARDLAND ,Clamp Forceps	137
Gall Duct and Cystic	355	GAUSS ,Scalp Flap Forceps	407
Haemorrhoidal	115,136	Gauze Packers	620
Hemostatic	115-127	GELLHORN ,Cervical Biopsy and Specimen Forceps	393
Hysterectomy	135-138	GELPI ,Abdominal Retractors	200
Intestinal Clamps	335-337,339	GERMINI ,Dissecting and Ligature Forceps	131
Iris	492-497	GERALD ,Dressing Forceps	98
Kidney Pedicle Clamps	352-353	Tissue Forceps	104
Ligature	109,435,-436	GERBORE ,Aortic Dilators	457
Multi Purpose	441,446	GERZOG ,Mallets	321
Muscle	327,490-491	GERZOG-SEXTON ,Knives	586
Nail Tearing out Toe and Finger Nails	309	GIERTZ-STILLE ,Rib Shears	412
Nasal	593-594	Gigli,Saws	506
Neonatal	454-455	Saws Handles	506
Parametrium	135	GIL-VERNET ,Retractors	154
Penis	365	GILL ,Corneal Knives	468
Pressure	137	Iris Forceps	496
Profunda	446	GILL-ARRUGA ,Capsular Forceps	497
Scalp Flap	138	GILL-HESS ,Iris Forceps	496
Sinus	145	GILLIES ,Cutaneous Hooks	150,329
Splinter	107-108	Needle Holders	233
Sterilizing	632	Needle Holders with Scissors TC	243
Stomach Clamps	340-341,343	Retractors	150
Strabismus	489-490	Tissue Forceps	103
Suture	488-489	GILLIES-SLIM ,Needle Holders	243
Tangential Occlusion	437	GILLS-WELSH ,Irrigation and Aspiration Cannulas	479
Tendon	322-324	GLOVER ,Anastomosis Clamps	428,437,442
Tissue	100-106,502	Atrauma Bulldog Clamps	425
Towel	142-143	GOELET ,Retractors	160
Trachoma	500		

	Pages #		Pages #
G			
Goitre, Grasping Forceps	372	HALSEY , Needle Holders	229
Instruments	327	HALSTEAD-MOSQUITO , Hemostatic Forceps	117-118
Probes	327	HAMBURG , Eye Knives Lanced Form	467
GLUCK , Rib Shears	90	HAMILTON-BAILY , Irrigating Cannulas	15
GOLDMAN-FOX , Gum Scissors	64, 92	HANK , Uterine Dilators	380
GOLDSTEIN , Eye Speculas	460	HANKEN , Auricule Clamps	433
Goniometers	5	Blood Vessel Clamps	422
Goniotomy Knives	469	HARDY , Dissectors	552
GOOD , Tonsil Scissors	61	Pituitary Curettes	560
GOODELL , Uterine Dilators	381	HARDY-FAHLBUSCH , Dissectors	552
GOSSET , Abdominal Retractors	201-202	HARM , Lachrymal Probes	484
Gouges	258-264, 603	HARRINGTON , Retractors	178
GOURDET , Uterine Curettes	399	HARRINGTON-BABY , Retractors	178
GRADLE , Cilia Forceps	109	HARRINGTON-PEMBERTON , Retractors	178
GRAEFE , Cataract Knives	468	HARTMANN , Bone Rongeur Forceps	300
Cataract Spoons	475	Ear Catheters	568
Corneal Scarifiers	473	Ear Hooks	586
Cystotomes	470	Ear Polypus Forceps	570-571
Eye Scissors	83	Ear Speculas	564-566
Eye Speculas	461	Hemostatic Forceps	117
Fixation Forceps	502	Nasal Cutting Forceps	596
Iris Forceps	494-495	Nasal Polypus Forceps	594
Iris Hooks	471	Nasal Speculas	589-592
Iris Knives	464	Tongue Depressors	618
Lens Hooks	475	Tonsil Punch Forceps	625
Skin Hooks	151	Tuning Forks	567-568
Strabismus Hooks	472	Wash Cannulas	614
GRAEFE-ARRUGA , Cataract Knives	464	HARTMANN-CITELLI , Ear Polypus Forceps	571
GRAETHER , Collar Botton Cannulas	482	HARTMANN-HALLE , Nasal Speculas	590
GRAHAM , Nerve Retractors	525	HARTMANN-NOYES , Ear Polypus Forceps	571
Grasping Forceps	105-106, 112, 534	HARTMANN-WEINGARTNER , Ear Polypus Forceps	571
GRAVE , Vaginal Speculas	367-368	HARTMANN-WULLSTEIN , Ear Polypus Forceps	571
Vaginal Speculas For Laser Surgery	368	HARVEY , Wire Cutting Scissors	87
GRAY , Gall Duct Forceps	355	HASLINGER , Uvula Retractors	622
GRAZIL , Operating Scissors	40	HAYES , Atrauma Sidmiod Anastomosis Forceps	336
GREEN , Corneal Dissectors	470	Head Extractors	407
Double Spatulas	485	Head Lamps	4
Eye Muscle Hooks	471	HEANEY , Hysterectomy Forceps	135
Fixation Forceps	504	Needle Holders	230
Retractors	172	Retractors	179
GREEN-ARMYTAGE , Uterine Haemostasis Forceps	406	Uterine Curettes	400
GREENE , Uterine Curettes	400	HEANEY-BALLENTINE , Hysterectomy Forceps	136
GREGORY , Profunda Clamps	446	HEANEY-SLIM , Hysterectomy Forceps	135
GREGORY-SOFT , Bulldog Clamps	426	HEATH , Ligature Scissors	86
GREVEN , Ear Polypus Forceps	573	Mallets	320
GROSS , Foreign Body Instruments	586	HEBRA , Chalazion Curettes	476
GROSS-MAIER , Polypus and Dressing Forceps	146	Comedone Extractors	328
GRUBER , Ear Speculas	565	HEGAR , Needle Holders	230
GRUENWALD , Dressing Forceps	99	Uterine Dilators	379
Nasal Cutting Forceps	596	HEGAR-BAUMGARTNER , Needle Holders	229
GRUENWALD (JANSEN) , Nasal Dressing Forceps	593	Needle Holder TC	236
GUEDEL-NEGUS , Laryngoscopes	19	HEGAR-VASCULAR , Needle Holders	238
Gum Scissors	64, 92-94	HEGEMANN , Vascular Scissors	58
GUTHRIE , Double Fixation Hooks	472	HEGENBARTH , Clip Applying Forceps	255
Skin Hooks	151	HEIFETZ , Brain Spatulas	520
GUTTMANN , Secretion Scoops	366	HEISS , Dissecting and Ligature Forceps	130
GUYON , Catheter Introducing Instruments	364	HEISTER , Mouth Gags	617
Atrauma Kidney Pedicle Clamp	352	HELFERRICH-BIER , Amputation Saws	310
Forceps	352	Hemilaminectomy Retractors	197
Kidney Pedicle Clamps Forceps	352-353	Hemostatic Forceps	115-127
GUYON-LUNDSGAARD , Sclerotomes	469	HENLEY , Retractors	193
Gynecological Instruments	364-404	Dissectomy Retractors	516
Gynecological Scissors	49-50	HENKE , Tonsil Elevators	622
H		HENNER (LEMPERT) , Retractors	192
HABERER , Abdominal and Intestinal Spatulas	180	HENNING , Plaster Spreaders	256
Intestinal and Stomach Clamps Forceps	343	HENRY , Cilia Forceps	109
Haemorrhoidal, Clamps	115, 136	HEPP-SCHIEDL , Micro Needle Holders TC	227
Forceps	349-351	HERRICK , Kidney Pedicle Clamp Forceps	353
Ligators	350-351	HERTZLER , Retractors	202
HAGLUND-STILLE , Plater Spreaders	256	HESS , Capsular Forceps	497
HAIGHT , Rib Spreaders	415	Iris Forceps	492
HAJEK , Mallets	320	Lens Expressors	475
Nasal Cutting Forceps	596	HEY , Dissectomy Retractors	514
HAJEK-KOFLER , Laminectomy Rongeurs	537	HEY-GROVES , Bone Holding Forceps	294
Septum Forceps	597-598	HEYMANN , Nasal Scissors	63
HALLE , Bone Curettes	270	Nasal Scissors, SuperCut	37
Nasal Scissors	63	Polypus Forceps	594
Septum Elevators	601	HEYWOOD-SMITH , Bone Hemorrhoidal Forceps	349
		Uterus Polypus Forceps	388

	Pages #		Pages #
HIBBS ,Bone Chisels	263		
Gouges	263		
Osteotomes	263		
Retractors	179		
HIRSCHMANN ,Anusscopes	345		
Eye Spatulas	474		
Iris Hooks	471		
HOEN ,Elevators	282,517		
Nerve Retractors	524		
HOESEL ,Needle Holders TC	242		
Retractors	170		
HOFER ,Tonsil Retractors	622		
HOFFER ,Marking Instruments	487		
HOFFMANN ,Tubing Forceps	144		
HOHMANN ,Bone Levers	285-286		
HOHMANN-ALDINGER ,Bone Levers	287		
HOKE ,Osteotomes	260		
HOLSHER ,Nerve Root Retractors	522		
HOLZBACH ,Hysterectomy Forceps	137		
HOLZHEIMER ,Retractors	191		
Hooks,Autopsy	31		
Handles	506		
Wood and Nerve	150-151		
HOPKIN ,Plaster Knives	256		
HORSLEY ,Elevators	519		
Hose Connecting Pieces	401		
HOSOBUCHI ,Spatulas	561		
HOUGH ,Micro Forceps	573		
HOUSE ,Micro Hooks	581		
Micro Spoons	582		
Suction Tubes	568		
HOWARD ,Septum Elevators	601		
HUBER ,Universal Handles	628		
HUDSON ,Bone hand Drills	311		
Conical and Spherical Burrs	311		
HUMBY ,Retractors	153		
HUNTER ,Splinter Forceps	108		
HURD ,Tonsil Elevators	622		
Tonsil Needles	620		
HYLIN ,Periosteal Raspatories	277		
Hysterectomy Forceps	135-138		
 I			
Incision Scissors	42		
INGE ,Lamina Spreaders	513		
Inhalers	14		
Instrumentation For D.B.Kirby	486		
Instruments For Brain Suture	508		
For Cranial Opening	506		
For Radial Keratotomy	487		
Interchangeable Tips	629		
Interosseous Knives	27		
Intervertebral Disc Rongeur	526-529		
Intestinal and Stomach Clamps	340-341,343		
and Stomach Twin Clamp Forceps	341-343		
Clamp Forceps	335-337,339		
Tissue Forceps	330-331		
IOWA ,Pelvimeters	405		
Tenaculum Forceps	388		
Iridectomy Scissors	65-69		
Iris,Forceps	492-497		
Hooks	471		
Knives	468		
Scissors	53		
Scissors SuperCut	35		
Spatulas	473-474,485		
Irrigating,Cannulas	478		
Vectis Cannulas	479		
Aspiration Cannulas	479		
ISRAEL ,Retractors	166		
ITERD ,Ear Catheters	568		
ITERSON ,Wound Retractors	156		
IVES-FANSLER ,Anusscopes	316		
 J			
Wound Retractors	153,156		
JACKSON ,			
		Vaginal Speculas	370
		JACOBI ,Eye Ligature Needles	505
		JACOBS ,Tenaculum Forceps	388
		JACOBSON ,Bone Curettes	271
		Mirco Needle Holders	228
		Micro Needle Holders TC	217
		Micro Probes	544
		Micro Scissors	73
		Micro Suture Pusher and Knot Tiers	544
		Micro Vessel Needles	541
		Micro Vessel Probes	544
		JACOBSON-ADSON ,Dressing Forceps	96
		Hemostatic Forceps	124
		JACOBSON-HALSTEAD ,Hemosatic Forceps	117
		JAEFE ,Eye Speculas	474
		JAEGER ,Eye Hooks	471
		Keratomes	465
		Lid Plates	463
		JAEGER-GRIESHABER ,Keratomes	465
		JAMESON ,Needle Holders	231
		Scissors	52
		Scissors, SuperCut	35
		Strabismus Forceps	490
		Strabismus Hooks	471
		JANNETTA ,Micro Dissectors,Elevators	546
		Micro Surgery Instruments	546
		JANSEN ,Bone Curettes	271
		Bone Rongeur Forceps	301-302
		Capsular Polishing Cannulas	481
		Dressing Forceps	569
		Ear Forceps	111
		Head Lamps	4
		Nasal Forceps	111
		Periosteal Raspatories	275
		Retractors	191
		Spoons	585
		Tissue Forceps	111
		JANSEN-DEEP ,Retractors	191
		JANSEN (GRUENWALD) Ear Forceps	111
		Nasal Forceps	111,593
		JAVID ,Carotid Clamps	448
		JEFFE-KNOLLE ,Iris Hooks	471
		JENNING ,Mouth Gags	617
		JOBSEN-HORNE ,Cotton Applicators	212
		JOHNS-HOPKINS ,Applying Forceps	115
		Bulldog Clamps	115
		Dissecting and Ligature Forceps	128
		JONES ,Towel Forceps	142
		JOSEPH ,Nasal Rasps	608
		Nasal Saws	605
		Periosteal Elevators	601
		Raspatories	602
		Rhinoplastic Hooks	609
		Rhinoplastic Knives	599
		Scissors	54
		Septum Elevators	601
		JOSEPH-COTTLE ,Septum Forceps Elevators	602
		JUDD-ALLIS ,Intestinal Tissue Forceps	331
		JUDD-MASSON ,Bladder Retractors	361-362
		JUERS ,Micro Forceps	573
		JURASZ ,Adeniod Cutting Forceps	599
		Laryngeal Polypus Forceps	631
 K			
		KADER ,Abdominal and Intestinal Spatulas	180
		KALLMORGEN ,Vaginal Speculas	374
		KALT ,Capsular Forceps	498
		Micro Needle Holders	225
		Micro Needle Holders TC	227
		KALT_ARRUGA ,Micro Needle Holders	225
		KANTROWITZ ,Hemostatic Forceps	127
		KATSCH ,Comedone Extractors	328
		KATZIN ,Iridectomy Scissors	68
		KATZIN-BARRAQUER ,Iridectomy Scissors	68
		KAZANIJIAN ,Bone Cutting Forceps	308
		Septum Forceps	597
		KELLY ,Fistula Scissors	50

	Pages #		Pages #
Hemostatic Forceps	118,126	KNOWLES ,Bandage Scissors	89
Proctoscopes	316	KOCHER ,Bladder Retractors	362
Retractors	173-174,176	Bulb Headed Probes	327
Sphincteroscopes	346	Goitre Directors	327
KELLY-RANKIN ,Hemostatic Forceps	118	Hemostatic Forceps	121
KELSEY-FRY ,Awls	189	Intestinal Clamps Forceps	337
Keratomes	465-466	Ligature Needles	247
KERN ,Bone Holding Forceps	295	Retractors	164,169-170,175
KERRISON ,Antrum Rongeurs	584	KOCHER-ATRAUMA ,Intestinal Clamp	337
KEVORKIAN ,Biopsy Curettes	392	Forceps	169
Cervical Biopsy and Specimen Forceps	395,398	KOCHER-LANGENBECK ,Retractors	169
KEY ,Elevators	283	KOCHER-WAGNER ,Retractors	283
KIDNEY ,Pedicle Clamp and Forceps	352-353	KOENIG ,Elevators	254
Stone Forceps	354	Ligature Conductors	276
KIELLAND ,Obstetrical Forceps	410	Periosteal Raspatories	157
KIELLAND-LUIKART ,Ostetrical Forceps	410	Retractors	166-167
KILLIAN ,Gouges	603	KOERTE ,Retractors	166
Laryngeal Polypus Forceps	631	KOERTE-WANGER ,Retractors	381
Nasal Speculas	591	KOGAN ,Endospeculas	381
Septum Elevators	502	KOGAN-LASER ,Endospeculas	32
Wash Cannulas	614	KOLLE ,Microscope Needle Holders	541
KILLIAN-CLAUS ,Gouges	603	KOOS ,Micro Vessel Knives	480
KILLIAN-DOUGHTY ,Mouth Gags	615	KRATZ ,Capsule Polishing Cannulas	479
KILNER ,Needle Holders TC	237	Cystotome Cannulas	569
Retractors	150	KRAUSE ,Ear polypus Snares	593
Rhinoplastic Hooks	610	Nasal Snares	629
Scissors	55	Tips	8
Skin Hook	329	Trocars	529
KIRBY ,Capsular Forceps	486	KRAUSE-VOSS ,Ear Ploypus Forceps	569
Fixation Forceps	486	Nasal Snares	593
KIRCH ,Cheek Retractors	182	KRAYENBUL ,Ligature Guides	543
KIRSCHNER ,Abodominal Retractors	207	KREMER ,Corneal Fixation Forceps	501
Extension Bows	317	KRESSNER ,Septum Punch Forceps	611
Ligature Conductors	253	KRISTELLER ,Vaginal Speculas	371-373
Traction Hooks For Extension Bows	318	KROENIG ,Tongue Depressors	618
Wire Strainers For Extension Bows	318	KROENLEIN ,Hemostatic Forceps	122
KLAPP ,Tendon Sheath Hooks	158	KRONECKER ,Ligature Needles	247
KLEINERT-KUTZ ,Bone Rongeur Forceps	303	KUEHNE ,Cover Glass Forceps	110
Retractors	153	KUEMMEL ,Retractors	171
Tendon Passing Forceps	323	KUHNT ,Corneal Scarifiers	468
KLEINSCHMIDT ,Blindgut Forceps	339	KWITKO ,Eye Spatulas	475
KLINGENBERG-LOTH ,Vascular Scissors	57		
KNAPP ,Cataract Spoons	475	L	
Discission Knives	467	LA BORDE ,Trachea Dilators	325
Eye Hooks	472	Lachrymal,Cannulas	481
Scissors	54	Dilators	483-484
Trachoma Forceps	472,500	Probes	484
KNAPP-CLARK ,Eye Speculas	461	Sac Dissectors	477
KNAPP-ROLLET ,Eye Hooks	472	Sac Hooks	470
KNIGHT -Nasal Scissors	63	LA FORCE ,Foreign Body Instruments	470
Knives,Amputation	27	Adenotome	613
Autopsy	28-29,31	LA GANGE ,Eye Scissors	83
Brain	28	Gum Scissors	93
Capsulotomy	468	LAHEY ,Gall Duct Clamps	134
Cartilage	29	Goitre Grasping Forceps	327
Cataract	464	Retractors	168
Cone	390	LAMBERT ,Chalazion Forceps	500
Corneal	468	LAMBERT-KAY ,Aortic Anastomosis Clamps	438
Discission	467	LAMBOTTE ,Bone Holding Forceps	296-297
Eye	464-468	Bone Osteotomes	261
Fistula	26	Periosteal Raspatories	282
Flap	27	Lamina Spreaders	509-513
Goniotomy	468	Laminectomy Reongeurs	530-534,536-537
Interosseous	27	LANCASTER ,Eye Speculas	461
Iris	468	LANDAU ,Trocars	7
Meniscotomy	291	Vaginal Speculas	377
Moncorps	329	LANDOLT ,Enucleation Scissors	52
Myoma	390	Pituitary Rongeurs	535
Nerve Knives	525	Scissors	52
Phalangeal	27	LANDOLT-REULEN ,Dissectors	562
Plaster	256	Hooks	562
Post Mortem	28	LANE ,Bone Holding Forceps	297
Pterygium	469	Bone Levers	288
Ptosis	469	Stomach Clamps	341
Resection	28	Tissue Forceps	105
KNOLLE ,Iris Hooks	471	Towel Forceps	143
KNOLLE-KELMANN ,Cystotome Cannulas	479	LANE-TRETHOWAN ,Bone Levers	288
KNOLLE-PEARCE ,Irrigating Vectis Cannulas	480		
Knot Tiers	254		

	Pages #		Pages #
L			
LANG ,Bone Lachrymal Sac Dissectors	477	LISTON ,Amputation Knives	27
LANGE ,Bandage Scissors	89	Bone Cutting Forceps	307
Rhinoplastic Hooks	609	LISTON-KEY ,Bone Cutting Forceps	308
LANGE-WILDE ,Ear Polypus Snare	569	LITTAUER ,Ligature Scissors	85
Nasal Snare	593	Polypus Forceps	570
LANGENBECK ,Amputation Saws	310	LITTAUER-LISTON ,Bone Cutting Forceps	307
Bone Holding Forceps	293	LITTLE ,Retractors	154
Curettes	585	LITTLER ,Ligature Scissors	85
Elevators	282	LITTLEWOOD ,Intestinal Tissue Forceps	331
Finger Protectors	619	Liver Retractors	176
Flap Knives	27	Lobectomy Scissors	61
Needle Holders TC	240	Locators	471
Periosteal Raspatories	274	LOCKHART-MUMMARY ,Fistula Probes	211
Phalangeal Knives	27	LOCKLIN ,Gum Scissors	93
Resection Knives	28	LOCKWOOD ,Intestinal Tissue Forceps	331
Retractors	168	LOCKWOOD-ALLIS ,Intestinal Tissue Forceps	330
LANGENBECK-GREEN ,Retractors	158	LONG ,Clamp Forceps	137
LANGENBECK-RYDER ,Needle Holders TC	240	Loop Twisters	256
LARSEN ,Tendon Seizing Instruments	323	LORENZ ,Bandage Scissors	88
Laryngeal Mirrors	630	LORNA ,Towel Forceps	143
Laryngeal Polypus Forceps	631	LOUTE ,Bone wire Tightners	319
Laryngo-Broncho-Esophagoscopy Instruments	626	LOVE ,Nerve Root Retractors	521-522
Laryngoscopes	16-19	LOVE-ADSON ,Elevators	517
LaryngoscopesHandles	19	LOVE-GRUENWALD ,Laminectomy, Rongeurs	530-531
Laser,Depth Rulers	383	LOVE-KERRISON ,Ronguers	528
Hooks	384	LOVE-MORSE ,Retractors	154
Measuring Instruments	383-384	LOVELACE ,Hemostatic Forceps	123
Measuring Probes	383	Lung Grasping Forceps	421
Latertal Speculas	368	LOWER ,Gall Duct Clamp Forceps	131
LAWRENCE ,Dissecting Forceps	134	LOWMAN ,Bone Holding Forceps	298
LEBSCHKE ,Sternum Chisels	412	LOWMAN-HOGLUND ,Bone Holding Forceps	298
LEES ,Bronchus Clamps	434	LUBERT-BARBON ,Tampon Forceps	593
LEGUEU ,Bladder Retractors	361-362	LUC ,Septum Forceps	594
LEKSELL ,Bone Rongeur Forceps	306	LUCAE ,Ear Forceps	569
LELAND-JONES ,Atrauma Cardiovascular Forceps	429	Hooks	586
LEMMON ,Rib Conductors	420	Knives	587
LEMPERT ,Bone Rongeur Forceps	301	Tuning Forks	567
Knives	587	LUER ,Bone Rongeur Forceps	302
Lens,Expressors	475	Retractors	157
Hooks	474-475	Trachea Tubes	326
Manipulating Cannulas	479	LUER-KOERTE ,Gall Stone Scoops	358
Scoops	475	LUMBARD-MAYO ,Airways	14
LERCHE ,Tissue Forceps	101	LUNDSGAARD ,Sklerotomes	469
LERICHE ,Abdominal and Intestinal Spatulas	180	Lung,Grasping Forceps,	421
Hemostatic Forceps	120	Spatulas	420
LESTER ,Fixarion Forceps	503	LUNIATSCHEK ,Tonsil Elevators	622
LEVINSON ,Foreign Body Needles	469	Tonsil Gauze Packers	620
LEWIN ,Bone Holding Forceps	293	Lupus,Curettes	329
LEWIS ,Lens Scoops	475	Scrapers	329
Nasal Rasps	608		
LEXER ,Bone Chisels	239		
Dissecting Scissors	41	M	
Dissecting Scissors,SuperCut	34		
Dissecting Scissors, TC	41	MAGILL ,Catheters Forceps	14
Gouges	259,261,264	Ear Cannulas	15
Osteotomes	261	Nasal Cannulas	15
LEXER-BABY ,Scissors	54	Suction Tubes	12
LEXER-FINE ,Dissecting Scissors	41	Malleable Spatulas	180
Dissecting Scissors, TC	41	Mallets	320-321
LICHTENBERG ,Needle Holders	233	MALTZ ,Nasal Rasps	608
Needle Holders TC	240	Nasal Rasps TC	607
LICHTWITZ ,Antrum Trocars	8	Rhinoplastic Knives	600
Lid,Instruments	463	MARKHAM-MEYERDING ,Retractors	201
Plates	463	Marking Instruments	483-487
Retractors	463	MARSCHIK-KRONI ,Tonsil Seizing Forceps	623
Ligature,Catchers	256	MARWALDER ,Bone Cutting Forceps	307
Clamp Forceps	109,435-436,446,452	MARQUARDT ,Bone Rongeur Forceps	304
Conductors	251-254	MARTEL ,Scalp Flap Forceps	138
Guides	543	Conductors	506
Instruments	620	MARTIN ,Bone Holding Forceps,	293
Needles	244-252	Cartilage Scissors	57
Rubber Rings	351	Pelvimeters	405
Scissors	86-87	Retractors	176
LINDNER ,Cyclodialyse Spatulas and Spoons	485	Tenaculum Forceps	385
LISTER ,Bandage Scissors	88	Uterine Sounds	382
Bandage Scissors, SuperCut	37	MARTINI ,Bone Curettes	271
Sinus Forceps	145	MASING ,Chisels	604
LISTER-BURCH ,Eye Speculas	462	Septum Elevators	602
LISTER-EXCENTRIC ,Scissors	88		

M	Pages #		Pages #
MASS.-GENERAL HOSPITAL ,Elevators	282	MICHEAL ,Clip Applying Forceps	225
Needle Holders	231	Laryngeal Mirrors	630
MASSON ,Needle Holders	231	Micro,Curettes	554-555
Needle Holders TC	239	Dissectors	542-547,552,556-559
MASTIN ,Muscle Forceps	327	Ear Polypus Forceps	572-576
MATHIEU ,Foreign Body Forceps	365	Elevators	542
Needle Holders	234	Forceps	572-576
Needle Holders TC	240,272	Hooks	546-547,550,556
Rectal Speculas	344	Instruments	538-563,572-583
Retractors	161	Instruments with Finger Grip	543
Vaginal Speculas	375	Knives	548
MATHIEU-KOCHER ,Needle Holders TC	241	Laryngeal Cup Forceps	626
MATHIEU-RYDER ,Needle Holders TC	240	Laryngeal Forceps	626
MATSON ,Periosteal Raspatories	277	Laryngo Scissors	626
MATZENAUER ,Vaginal Speculas	375	Ligature Needles	547,549,551
MAYFIELD ,Bone Rongeur Forceps	303	Measuring Road	581
MAYO ,Gall Stone Scoops	359	Mobilizers	581
Grasping Forceps	105	Needles	579-580
Tongue Depressors	618	Needle Holders	216-226
Scissors	43	Needle Holders TC	226
Scissors, SuperCut	34	Nerve Hooks	543-545-547,550-551,556
Scissors, TC	43	Raspatories	549,553,556
Sterilizing Clamps	632	Scissors	70-79,573-575,577
MAYO-ADAMS ,Abdominal Retractors	199	Scoops	556
MAYO-BLAKE ,Gall Stone Forceps	356	Vessel Dilators	544
MAYO-COLLIN ,Retractors	161	Vessel Knives	541
MAYO-GUYON ,Kidney Pedicle Clamp,Forceps	353	MICRO-ADSON ,Dressing Forceps	96
MAYO-HEGAR ,Needle Holders	230	, Tissue Forceps	102
Needle Holders TC	236	MICRO-MOSQUITO ,Hemostatic Forceps	117
MAYO-NOBLES ,Scissors	44	Microscopic,Instruments	32
MAYO-ROBSON ,Atrauma Intestinal Clamp,Forceps	335	Needle Holders	32
MAYO-STILLE ,Scissors	43	Needles	32
Scissors, SuperCut	34	Scissors	84
Scissors, TC	43	MIDDELDORPF ,Retractors	172
McCULLOUGH ,Strabismus Forceps	489	MIDDLE-JANSEN ,Septum Forceps	597
McDONALD ,Elevators	283	MIKULICZ ,Intestinal Clamp Forceps	140-141
McGANNEN ,Iris Hooks	471	Peritoneal Clamp Forceps	140-141
McGEE ,Micro Hooks	580	Retractors	176
Wire Closure Forceps	576	MILAN ,Uterine Curettes	401
McGEE-FISCH ,Wire Closure Forceps	576	MILLER ,Bone Rasps	607
McGIVEN ,Haemorrhoidal Forceps	351	Retractors	150
Haemorrhoidal Ligators	351	MILLER-BABY ,Laryngoscopes	19
McINDOE ,Bone Cutting Forceps	307	MILLES ,Micro Scissors	75
Cartilage Scissors	57	MILLIGAN ,Retractors	193
Dressing Forceps	96	Elevators	519
McINTOSH ,Laryngoscopes	16	MILLIN ,Bladder Retractors	361
McIVOR ,Mouth Gags	615	Prostatic Lobe Holding Forceps	360
McLEAN ,Obstetrical Forceps	410	Suction Tubes	13
McKENTY ,Septum Elevators	601	MILLS ,Neurosurgical Scissors	84
McKENZIE ,Applying Forceps	508	MILLIS ,Mirco Scissors	75
McPHERSON ,Suture Forceps	488	MINI-FRIEDMANN ,Bone Rongeur Forceps	299
McQUIGG-MIXTER ,Gall Duct Clamps	133	MINI-GEMINI ,Dissecting and Ligature,Forceps	132
MEAD ,Bone Rongeur Forceps	301	MINI-HOHMANN ,Bone Levers	284
Mallets	321	MINI-LAMBOTTE , BoneOsteotomes	261
MEEKER ,Dissecting and Ligature Forceps	31	MINI-LANGENBECK ,Retractors	152
MELLINGER ,Eye Speculas	460	MINI-LEXER ,Bone Chisels	261
MELLINGER-AXENFELD ,Eye Speculas	460	Bone Gouges	261
MELLINGER-BEARD ,Eye Speculas	461	MINI-ROUX ,Retractors	160
Meniscotomy Knives	291	MINI-TOWNSEND ,Cervical Biopsy and Specimen Forceps	398
Meniscus,Knives	291	Mirror Handles	563
Retractors	290	Mirrors	563
MERCEDES ,Thoracic Retractors	417	MITCHELL ,Cannulas	15
MERSHON ,Band Pushers	189	MIXTER ,Dissecting and Ligature Forceps	132-133
Messer	578	Scissors	132
Metal Catheters	364	MIXTER-SHAUGHNESSY ,Dissecting and Ligature Forceps	132
Handles For Laryngeal Mirrors	630	MIXTER-SLIM ,Dissecting and Ligature Forceps	132
Support For Ear Speculas	566	Scissors	62
METZENBAUM ,Dissecting Scissors	44-48	MOD.USA ,Umbilical Scissors	48,62
Dissecting Scissors TC	44-48	MOLTGEN ,Goniometers	591
Scissors, SuperCut	34	MOHR ,Tubing Forceps	5
METZENBAUM-FINE ,Dissecting Scissors	44-48	MOLLISON ,Retractors	144
Scissors SuperCut	34	MOLT ,Mouth Gags	192
MEYER ,Foreign Body Gouges	470	MOLT-BABY ,Mouth Gags	616
MEYER,SCHWICKERATH ,Locators	471	MONCORPS ,Knives	616
MEYERDING ,Abdominal Retractors	200	MOORE ,Gall Bladder Scoops	329
Retractors	156,179	MOOREFIELD ,Suture Forceps	359
MEYHOEFER ,Chalazion Curettes	476		

M	Pages #	Pages #
MORITZ-SCHMIDT , Tongue Depressors	503	Needle Holders 229
MORRIS , Retractors	617	Needle Holders TC 235
MORRIS-DE-BAKEY , Aortic Anastomosis, Clamps	171	NEW SUTURE , Scissors 42
MORRIS-FAVALORO , Rib Spreaders	442	NICATI , Foreign Chisels 470
MOSQUITO , Atrauma Hemostatic Forceps	417	NICOLA , Pituitary Curettes 560
MOSQUITO-DANDY , Hemostatic Forceps	444	Pituitary Instruments 560-561
Mouth Gags	122	Nicro , Gum Scissors 92
MOYNIHAN , Gall Duct Clamps	615-617	NISSEN , Gall Duct Forceps 355
MUCK , Knives	137	Hemostatic Forceps 124
MUELLER , Eye Speculas	586	NORTHBENT , Ligature Scissors 85
MUENCHEN , Biopsy Curettes	462	NORWOOD , Rectal Snares 349
MULDOON , Eye Speculas	391	NOTO , Uterus Polypus Forceps 388
Multipose Clamps	484	NOTT , Vaginal Speculas 370
MURDOCK , Eye Speculas	441, 446	NOVAK , Biopsy Curettes 391
MURLESS , Head Extractors	462	NOVAK-SCHOEKAERT , Biopsy Curettes 391
MURPHY , Retractors	407	NOYES , Iridectomy Scissors 65
MURPHY-LANE , Bone Levers	165	NUBOER , Suction Tubes 4
Muscle, Forceps	289	NUGENT , Strabismus Forceps 489
Hooks	327, 490-491	NUSSBAUM , Intestinal Clamp Forceps 339
Retractors	31	Stomach Clamp Forceps 343
MUSEUX , Tenaculum Forceps	514-515	
Tonsil Seizing Forceps	387	
MYERS , Vein Strippers	623	
MYLES , Nasal Cutting Forceps	214	
Myoma, Knives	596	
Screws	390	
Myrtle Blade Probes	390	
	210	
	214	
NABATOFF , Varicose Vein Probe Set	214	
NAEGELE , Obstetrical Forceps	407	
Perforators	409	
NAGER , Tonsil Elevators	622	
Tonsil Needles	620	
Tonsil Retractors	622	
Nail, Instruments	309	
Nippers	633	
Scissors	94	
Splitting Scissors	87	
Nasal, Cannulas	1	
Curettes	612	
Cutting Forceps	596	
Knives	599-600	
Rasps	606-608	
Saws	605	
Scissors	63	
Snares	593	
Speculas	589-592	
Needle, Holders	229-234	
Holders TC	235-242	
Holders with Scissors	232-233	
Holders with Scissors TC	243	
Holders, Micro	216-226	
Micro TC	227-228	
NEFF , Bone Holding Forceps	292	
Meniscotomy Knives	281	
NEGUS , Adenoid Curettes	612	
Artery Forceps	136	
NEIVERT , Needle Holders TC	235	
NEIVERT-MASING , Rhinoplastic Hooks	609	
NELATON , Probes	210	
NELSON , Grasping Forceps	106	
Trocars	8	
Neontal Clamps	454-455	
Nephrostomy Forceps	354	
Nerve and Vessels Hooks	543	
Dissecting Scissors	60	
Hooks	551	
Retractors	522, 525	
Root Retractors	521-523	
NEUBUESER , Micro Scissors	98	
NEUMANN , Gum Scissors	93	
Neuro and Laminectomy Instruments	506-536	
Neuro Surgical, Scissors	84	
NEVYAS , Cystotome Cannulas	479	
NEW ORLEANS , Lens Scoops	475	
		O
		O CONNOR , Conjunctival Forceps 495
		Iris Hooks 47
		Nerve Hooks 151
		O'SULLIVAN-O'CONNOR , Abdominal, Retractors 208
		Vaginal Speculas 378
		Obstetrical Forceps 410-411
		Obstetrics Instruments 405-411
		OCHSNER , Aortic Clamps 432
		Ligature Forceps 109
		Trocars 8
		OCHSNER-KOCHER , Hemostatic Forceps 121
		OEHIEF , Tissue Forceps 100
		OLDBURG , Nerve Root Retractors 523
		Pituitary Rongeurs 535
		OLIVECRONA , Bone Rongeur Forceps 300
		Brain Spatulas 520
		Dissectors 519
		Elevators 519
		Trigeminal Scissors 64
		Wire Saws 506
		OLIVECRONA-TONNIS , Applying and Removing Forceps 508
		OLLIER , Retractors 169
		OLSEN-HEGAR , Needle Holders 232
		Needle Holders TC 243
		OKONOITO , Ear Polypus Forceps 570
		OMBREDANNE , Mallets 320
		Operating Knives 22-25, 38-40
		Operating Scissors 38-40, 42-44
		Operating Scissors, SuperCut 34
		Operating Scissors, TC 38-39, 43
		Ophthalmology Instruments 459-505
		Oral Instruments 615-619
		Orbit Spatulas 473
		Organ Grasping Forceps 332
		Otology Instruments 564-588
		Osteotomes 258, 260-263
		Osteotomes For Anatomy and Autopsy 31
		Osteotomes For Maxillofacial Surgery 188
		Ovarian Forceps 390
		OVERHOLT , Dissecting and Ligature Forceps 129
		Periosteal Raspatories 277
		OVERHOLT-GEISSENDOERFER , 130
		Dissecting and Ligature Forceps 130
		OVERHOLT-MIXTER , Dissecting and Ligature Forceps 129
		OVERHOLT-SLIM , Dissecting and Ligature Forceps 129
		P
		PACIFIC-KEVORKIAN , Cervical and Ligature Forceps 397
		PAPST , Round Keratome 466
		Parametrium, Forceps 135
		Scissors 62
		PARK , Anal Retractors 347

P	Pages #		Pages #
Eye Speculas	459	POOLE ,Suction Tubes	12
PARK-GUYTON ,Eye Speculas	459	Post Mortem Knives	28
PARK-MAUMENEE ,Eye Speculas	459	Post Mortem Needles	32
PARKER ,Retractors	160	POTTS-De MARTEL ,Neuro Surgical Scissors	8499
PARKER-LANGENBECK (US-ARMY) ,Retractors	160	POTTS-SMITH ,Dressing Forceps	36
PARKER-MOTT ,Retractors	161	Scissors, SuperCut	55-57
PARKES ,Rasps TC	607	Vascular Scissors	56
PARTSCH ,Bone Chisels	258	Vascular Scissors, TC	385
Bone Gouges	258	POZZI ,Tenaculum Forceps	211
Mallets	321	PRATT ,Fistula Probes	115
PASSOW ,Bone Chisels	258	Haemorrhoidal Clamps	344
Levers	255	Rectal Speculas	387
Patella Forceps	298	Tenaculum Forceps	380
PATON ,Corneal Dissectors	468	Uterine Dilators	293
Micro Needle Holders	217	PRESTON ,Bone Holding Forceps	421
PATTERSON ,Cervical Biopsy and Specimen Forceps	394	PRICE-THOMAS ,Bronchus Clamps	490
PAUFIQUE ,Suture Forceps	489	PRINCE ,Muscle Hooks	60
PAUL ,Eye Retractors	473	Tonsil Scissors	210-211
PAYR ,Intestinal Clamps	340	Probes,	210-211
Ligature Conductors	251	Bulb Headed	211
PEAN ,Hemostatic Forceps	116,121	Fistula	214
Trocars	7	For Varicose Veins	357
PEDERSON ,Vaginal Speculas	369	Gall Duct	357
Pediatric Clamps Atrauma	454	Gall Stone	327
PEERS-BERTRAM ,Towel Forceps	142	Goitre	544
PEET ,Splinter Forceps	108	Micro	210
PELKMANN ,Polypus Forceps	146	Myrtle Blade	210
PELTON ,Cotton Applicators	211	With Eye	346
Pelvimeters	405	Proctoscopes	446
PENFIELD ,Elevators	517	Profunda Clamps	360
Penis Clamps	365	Prostatic,Lobe Holding Forceps	360
PENNINGTON ,Hemostatic Forceps	116	Retractors	473
Raspatories	602	Protectors	120
Percussion Hammers	2-3	PROVIDENCE ,Hemostatic Forceps	469
PERCY ,Retractors	296	Pterygium Knives	469
Perforators	407	Ptosis Knives	482
Periosteal,Raspatories	274-281	Puncture Cannulas	273
Peritoneal,Clamp and Forceps	140-141	PUTTI ,Bone Rasps	339
PERTHES ,Reamers	312	Pylorus Spreaders	
Phalangeal,Knives	27		
PIERCE ,Septum Elevators	602		
Trocars	8	Q	
PIFFARD ,Skin Hooks	328	QUERVAIN ,Elevators	282
PINARD ,Stethoscopes	1	QUINBY ,Gum Scissors	92
PINSMED ,Razor Blade Breakers	30	QUIRE ,Foreign Body Levers	570
Swedish Patt.Needle Holders TC	238		
PIPER ,Ostetrical Forceps	411	R	
Pituitary,Cupped-Shaped Forceps	538-539	Rachiotomes	31
Curettes	559-560	Radial Keratotomy Instruments	487,501
Dissectors	562	RAGNELL-DAVIS ,Retractors	159
Enucleators	561	RADOLF ,Forceps For Tearing out Finger Nails	309
Forceps	538-539	RAMPLEY ,Sponge Holding Forceps	148
Hooks	561-562	RAMUS ,Retractors	185
Instruments	538-540,559-562	RANDALL ,Biopsy Curettes	391
Raspatories	549,553	Kidney Stone Forceps	354
Rongeurs	535	RANEY ,Applying and Removing Forceps	508
Scissors	538-540	Raspatories	188
Scoops	562	Raspatories For Maxillofacial Surgery	602
Spatulas	561	Rasps TC	606
Speculas	563	RAY ,Curettes	559
Placenta and Ovum Forceps	406	Razors	26
PLANGE ,Foreign Body Needles	470	Razor Blade Holders and Breakers	30
Plaster,Cast Forceps	257	RECAMIER ,Uterine Curettes	404
Knives	256	Rectal,Aspiration Cannulas	349
of Paris Shears	90	Biopsy Specimen Forceps	348
Saws	256	Coolers	349
Scissors	90	Snares	349
Spatulas	211	Speculas	344-345
Spreaders	256	REICHERT ,Epiglottis Retractors	631
Plastic Surgery Scissors, SuperCut	35	REINER ,Plaster Knives	256
PLESTER ,Micro Knives	578	RESANO ,Intestinal Clamp Forceps	336
Retractors	191	Resection,Knives	28
Suction Tubes	10	Saws	310
PLEY ,Eye Speculas	461	Retractors,	150-179,190-209,296
POLITZER ,Ear Speculas	564	For Maxillofacial Surgery	181-187
Knives	586-587	REVERDIN ,Abdominal and Intestinal,Spatulas	180
POLLOSON ,Retractors	177	Needles	249-250

R	Pages #	Pages #	
REYNOLDS ,Scissors	52	SAUERBRUCH-FREY ,Rib Shears	412
Scissors, SuperCut	35-36	SAUTER ,Air Injection Cannulas	182
Rhinology Instruments	589-614	SAUTTER ,Orbit Spatulas	473
Rhinoplastic,Hooks	609	Scalp Flap Forceps	138
Knives	599-600	Scalpel Handles	20-21
RHOTON ,Micro Surgical Instruments	545	SCHAEDEL ,Towel Forceps	142
Rib,Contractors	420	SCHAMBERG ,Comedone Extractors	328
Shears	412	SCHEDE ,Bone Curettes	268
Spreaders	413-419	SCHEIE ,Goniotomy Knives	469
RICARD ,Abdominal	200	SCHEINMANN ,Tips	629
RICHARDSON ,Retractors	173-174	SCHEPENS ,Lid Retractors	463
RICHARDSON-EASTMAN ,Retractors	173	SCHERBAK ,Vaginal Speculas	378
RICHAU-HOLGREN ,Ear Speculas	566	Schimmelbusch Inhalers	14
RICHTER ,Scissors	42	SCHINDLER ,Hystrectomy Forceps	141
Vulval Retractors	200	SCHLESINGER ,Laminectomy Rongeurs	534
RICHTER-HEATH ,Clip Applying Forceps	255	SCHMEDEN ,Nasal Cutting Forceps	596
RIGBY ,Abdominal Retractors	201	SCHMID ,Spatulas	215
RITTER-HALLE ,Wash Cannulas	614	Vessel Irrigating Cannulas	215
ROBERTS ,Hemostatic Forceps	126	SCHMIDEN-DICK ,Ligature Needles	248
ROCHESTER-CARMALT ,Hemostatic Forceps	122	SCHMIDEN-PAYR ,Ligature Conductors	253
ROCHESTER-PEAN ,Hemostatic Forceps	121	SCHMIDEN-TAYOR ,Dura Scissors	84
ROEDER ,Towel Forceps	143	SCHNIDER ,Periosteal Raspatories	275
Ligature Instruments	620	SCHNIDER-SAUERBRUCH ,Periosteal Rasptaoies	275
ROGERS ,Hysterectomy Forceps	135	SCHNIDT ,Hemostatic Forceps	125
ROGGE ,Sterilizing Forceps	632	SCHOEMAKER-LOTH ,Wire Cutting Scissors	86
ROLLET ,Extirpation Chisels	471	SCHOEBORN ,Thyroid Gland Retarctors	325
Tear Sac Hooks	472	SCHRECK ,Puncture Cannulas	462
ROSE ,Trachea Retractors	157	SCHROEDER ,Tenaculum Forceps	386
ROSEN ,Micro Curettes	581	Uterine Curettes	399
Micro Dissectors	581	SCHUBERT ,Cervical Biopsy and Specimen Forceps	393
Micro Hooks	579-580	SCHUHKNECHT ,Wire Cutting Scissors	87
Micro Knives	578	Knives	578
Micro Measuring Road	581	SCHUMACER ,Bone Levers	287
Micro Needles	579-580	Cervical Biopsy and Specimen Forceps	394-395
ROSEN-KONIG ,Mouth Gags	616	Umbilical Scissors	62
ROSS ,Retractors	181	Tips	629
ROUX ,Retractors	160	SCHWEIZ , Discission Needle	496
RUBIN ,Septum Forceps	611	Scissors,	34-94
RUBMAN-BORES ,Corneal Fixation Forceps	501	Abdominal	50
RUDD ,Haemorrhoidal Ligators	350	Arteritomy	60
RUMEL ,Dissecting and Ligature Forceps	128	Bandage	87-88
RUMEL-BELMONT ,Tourniquets	456	Cartilage	57
RUSKIN ,Bone Rongeur Forceps	303-304	Cephalotomy	50
RUSKIN-LISTON ,Bone Cutting Forceps	308	Clothing	90
RUSSIAN ,Tissue Forceps	105	Coronary	55
RYDEL-SEIFFERT ,Tuning Forks	567	Crown	91
RYDER ,Needle Holders TC	238	Dissecting	41,43-49,55,60,84
		Dura	84
		Endarterectomy	36
		Enterotomy	61
		Enucleation	52
		Episiotomy	62
		Eye	80-83
		Fine Operating Scissors	51-54,80
		Fistula	50
		Gum	92-94
		Gynecological	40-41
		Incision	42
		Iridectomy	65-69
		Iris	53
		Iris SuperCut	35
		Ligature	85-86
		Lobectomy	61
		Micro Dissecting	70-79
		Nail	94
		Nail Splitting	87
		Nasal	37,63
		Nerve Dissecting	60
		Neuro Surgical	84
		Parametrium	62
		Plaster	90
		Skin	53
		Sternum	412
		Strabismus	83
		SuperCut	34-37
		Tenotomy	37,82
		Tissue	38-40,42-44
		Tonsil	60-61

S

SAALFELD ,Comedone Extractors	328
SACHS ,Elevators	518-519
Dissectors	518-519
SAENGER ,Ovum Forceps	406
Safety Pins	632
SALENIUS ,Meniscotomy Knives	291
SAMIL ,Tumor Knives	548
SANDERS-BROWN ,Awls	189
SANTULLI ,Bulldog Clamps	426
SANVENERO ,Scissors	55
SAROT ,Hemostatic Forceps	127
Needle Holders	231
Needle Holders TC	238
SATINSKY ,Hemostatic Forceps	422
Vascular Scissors	57
SATINSKY-DE-BAKEY ,Tangential Occlusion Clamps	437
SATO ,Corneal Knives	468
Knife Cannulas	482
SATTERLEE ,Amputation Saws	310
SATTLER ,Muscle Forceps	491
SAUER ,Eye Speculas	461
SAUERBRUCH ,Bone Rongeur Forceps	306
Retractors	168,177
Rib Shears	412
Waste Forceps	632

S	Pages #		Pages #
Umbilical	62	SIMPSON-SMITH ,Suction Tubes	13
Uterine	34,49-50	SIMS ,Rectal Speculas,	344
Vascular	55-59	Uterine Curettes	402
Wire Cutting	86-87	Uterine Scissors	49
Scleral Hooks	472	Uterine Scissors SuperCut	35
Sclerotomes	469	Uterine Sounds	382
SCOVILLE ,Nerve Retractors	524	Vaginal Speculas	370
Nerve Root Retractors	522-523	SIMS-MAIER ,Dressing Forceps	146
SCOVILLE-HAVERFIELD ,Retractors	203	SINGLEY-TUTTLE ,Grasping Forceps	106
Screw,Drivers	318	Sinus Forceps	145
Nut Wrenches	318	SKENE ,Tenaculum Forceps	386
SCUDDER ,Intestinal Clamp Forceps	333	Skin,Curettes	328
SEBILEAU ,Elevators	283	Hooks	329
Secretion Scoops	341	Scissors	53
SEDILLOT ,Periosteal Raspatories	274	Skull Breakers	31
SEGOND ,Hysterectomy Forceps	141	SLUDER-BALLENGER ,Tonsillectome	625
Myoma Knives	390	SMELLIE ,Perforators	407
SEGOND-LANDAU ,Hysterectomy Forceps	141	SMILLIE ,Meniscotomy Knives	291
SEIFFERT ,Tips	629	Meniscus Retractors	290
SELDIN ,Periosteal Raspatories	275	SMITH(USA PATTERN) ,Bandage Scissors	89
SELLHEIM ,Elevating Spoons	407	SMITH ,Wire Cutting Scissors	87
SELLORS ,Rib Contractors	420	SMITH-BUIE ,Anal Retractors	345
SEMB ,Bone Cutting Forceps	308	SMITH-FISHER ,Iris Spatulas	485
Bone Holding Forceps	295	SMITH-PETERSON ,Bone Chisels	260
Bone Rongeur Forceps	305	Bone Gouges	260
Bronchus Clamps	422	Bone Rongeur Forceps	304
Periosteal Raspatories	278	SMITHWICK ,Nerve Retractors	526-527
SEMKEN ,Dressing Forceps	96	SNELLEN ,Ear Loops	585
Tissue Forceps	103	Entropium Forceps	491
SEMM ,Abdominal Retractors	207	Lens Scoops	475
Vaginal Speculas	369	SOERENSEN-HEIN ,Retractors	186
SENN-GREEN ,Retractors	159	SOMER ,Uterine Elevating Forceps	389
SENN-MILLER ,Retractors	159	Spatulas Dissectors	553
Sensibility Instruments	1	Speculas,Eye	459-462
Septum,Chisels	604	For Laser Surgery	368
Compression Forceps	611	Lateral	368
Elevators	601-602	Rectal	344-345
Forceps	594-595,597	Vaginal	366-378
Knives	599-600	SPENCER ,Ligature Scissors	85
Setting Forceps	424	SPENCER-FINE ,Ligature Scissors	85
SEUTIN ,Plaster and Bandage Scissors	90	SPENCER-WELLS ,Hemostatic Forceps	134
SEYFFERT ,Vaginal Speculas	369	Sphenoid Punches	584
SEWALL ,Curettes	612	Sphincterosopes	346
SEXTON ,Knives	586	SPINA-NASALIS ,Retractors	185
SHAPLEIGH ,Curettes	585	SPINAL ,Bone Curettes	272
SHEA ,Micro Scissors	573	Retractors	290
Spoons	582	Splinter Forceps	107-108
Shears,Plaster	90	Sponge Holding Forceps	148
Rib	412	Spoons For Ear	585
SHEETS ,Irrigating Vectis Cannulas	480	SPRAGUE ,Ear Operation Set	587
SHPEPARD ,Forceps	499	SPRATT ,Bone Curettes	267
SHORTBENT ,Ligature Scissors	85	SPURLING ,Laminectomy Rongeurs	530-531
SICHEL ,Iris Knives	468	ST.CLAIR-THOMPSON ,Adenoid Curettes	613
SICKLE ,Dissectors	549,553	ST.MARKS ,Retractors	171
Elevators	549	ST.MARTIN ,Suture Forceps	504
Hooks	550-551	STACK ,Probes	210
Knives	549	STANDARD-NELSON ,Trocars	6
Needles	549	STAUDE-MOORE ,Tenaculum Forceps	385
Raspatories	549	STEINMANN ,Tendon Grasping Forceps	323
SIEBENMANN ,Wash Cannulas	614	Tendon Passing Forceps	324
SIEBOLD Uterine Scissors, SuperCut	35	STELLBRINK ,Bone Rongeur Forceps	299
SIEGLE ,Ear Speculas	566	Sterilizing,Forceps	632
SILVER ,Chisels	604	Instruments	632
SIMCOE ,Capsule Polishing Cannulas	480	STERNBERG ,Tongue Depressors	617
Cortex Aspirating Cannulas	480	Sternum,Chisels	412
Irrigating Vectis Cannulas	480	Scissors	412
Irrigating/Aspiration Cannulas	479	Stethoscopes	1
SIMON ,Bone Curettes	269	STEVENS ,Iris Forceps	495
Fistula Hooks	390	Lens Hooks	473
Fistula Knives	26	Micro Needle Holders	225
Retractors	175	Tenotomy Scissors	82
Uterine Curettes	399	Tenotomy Scissors, SuperCut	37
SIMPSON ,Lachrymal Dilators	484	STEVENSON ,Eye Speculas	462
Obstetrical Forceps	409	STIEGLITZ ,Splinter Forceps	108
Uterine Sounds	382	STILLE ,Bone Chisels	263
SIMPSON-BRAUN ,Obstetrical Forceps	409	Bone Gouges	263
SIMPSON-LUIKART ,Obstetrical Forceps	409	Bone Osteotomes	263

S	Pages #		Pages #
Bone Rongeur Forceps	306	Picks	544,610
Double Ended Instruments	485	TOBOLD ,Tongue Depressors	618
Dressing Forceps	95	TOENNIS ,Dissecting and Ligature Forceps	131
Kidney Pedicle Clamp Forceps	353	Dissecting Scissors	60
Plaster of Paris Shears	90	Dissecting Scissors, TC	60
STILLE-BARRYA ,Tissue Forceps	106	Dissectors	517
STILLE-LISTON ,Bone Cutting Forceps	308	Knives	525
STILLE-LUER ,Bone Rongeur Forceps	305	Needle Holders	233
STILLE-RUSKIN ,Bone Rongeur Forceps	306	Needle Holders TC	241
STOCK ,Iris Spatulas	473	Nerve Retractors	525
STOCKMANN ,Penis Clamps	365	TOENNIS-ADSON ,Dissecting Scissors	60
Stomach and Intestinal Instruments	330-343	TOENNIS-ADSON-FINE ,Arteriotomy Scissors	60
Stomach Clamp Forceps	340-341,343	TOHOKU ,Towel Forceps	142
STONE ,Tissue Forceps	10	Tongue,Depressors	616-619
Strabismus,Forceps	489-490	Forceps	619
Hooks	473	Tonsil,Elevators	622
Scissors	83	Forceps	136,623
STRANDELL-STILLE ,Retractors	158	Hemostatic	136, 623
STRATTE ,Needle Holders TC	239	Instruments	621-625
STRAUSS ,Penis Clamps	365	Knives	621
STRULLY ,Neurosurgical Scissors	64,84	Needles	620
STRUMPEL ,Ear Polypus Forceps	571	Punches	625
STRUYCKEN ,Nasal Cutting Forceps	596	Retractors	622
Suction and Irrigating Cannulas	456	Scissors	61-62
Suction Tubes	9-13,568	Seizing Forceps	622
SUCKER ,Eye Spatulas	473	Snares	624
SULLIVAN ,Gum Scissors	93	Tonsillectomes	625
SuperCut Scissors	34-37	TOOK ,Corneal Kinves	468
Suture,Forceps	488-489	Tourniquets	456
Instruments	216-255	Towel Forceps	142-143
Pusher and Knot Tiers	544	TOWNLEY ,Calipers	5
SWEDISH-PATTERN ,Bone Curettes	267	TOWNSEND ,Biopsy Curettes	342
SWISS-MODEL ,Foreign Body Needles	469	TOYNBEE ,Ear Speculas	564
Iris Forceps	492	Trachea,Dilators	325
Vaginal Speculas	366	Retractors	325
		Trocars	325
		Tubes	326
		Tracheotomy Instruments	325-326
		Trachoma Forceps	500
		Traction Handle for Obstetrical Forceps	410
		TRAUBE ,Percussion Hammers	3
		TRAVERS ,Retractors	195
		TRELAT ,Tonsil Needles	620
		TRELET ,Vaginal Speculas	367
		TREVES ,Tissue Forceps	101
		Trigeminal Scissors	64
		Trocars	6-8
		TROELTSCH ,Ear and Nasal Forceps	111
		Ear Speculas	564
		TROELTSCH-WILDE ,Ear and Nasal Forceps	111,569
		Tampon Forceps	593
		TROEMNER ,Percussion Hammers	2
		TROUSSEAU ,Trachea Dilators	325
		TROUSSEAU-BABY ,Trachea Dilators	325
		TROUTMANN ,Iridectomy Scissors	68
		Lens Scoops	475
		TROUTMANN-BARRAQUER ,Iridectomy Scissors	67
		TROUTMANN CASTROVIEJO ,Iridectomy Scissors	69
		TROUTMANN-CHRIS ,Razor Blade Breakers	30
		TROUTMANN-COLIBRI ,Iris Forceps	497
		Trumpert Guide Needles	405
		TUBBS ,Aortic Dilators	457
		Tubing Forceps	144
		TUEBINGEN ,Iris Hooks	470
		Retractors	176,192
		Suture Forceps	488
		TUFFIER ,Abdominal and Intestinal Spatulas	180
		Hemostatic Forceps	115
		Retractors	175
		Rib Spreaders	414
		Tumor Grasping Forceps	112-113,535
		Knives	548
		Tuning Forks	567-568
		Twin Clamp Forceps	341,343
		TYDING ,Tonsil Snares	624

U

U	Pages #	Pages #	
UCKERMANN ,Cotton Applicators	212	WALTER ,Chisels	604
Trachea Trocars	325	WALTER-CARMALT ,Splinter Forceps	108
UFFENORDE ,Bone Curettes	268	WALTON ,Foreign Body Chisels	47
ULRICH ,Cotton Swab Forceps	145	Scissors	53
Fistula Knives	26	WANGENSTEEN ,Dressing Forceps	99
Vaginal Speculas	375	Needle Holders	231
Umbilical,Cord Clamps	408	Needle Holders TC	239
Scissors	62	WARTENBURG ,Sensibility Instruments	1
UNIVERSAL ,Bandage Scissors	87	WASSMUND ,Retractors	166
Cotton Applicators	212	Waste Forceps	632
Handles	628	Watchmaker's Forceps	106,504
Sterilizing Forceps	632	WATSON-CHEYNE ,Elevators	283
Trocars	6	Probes	210
Wire Cutting Scissors	88	WATSON-WILLIAMS ,Septum Forceps	595
Wire Cutting Scissors TC	64	WAUGH ,Dressing Forceps	97
UNNA ,Comedone Extractors	328	Tissue Forceps	104
Urology Instruments	365	WEBER ,Aortic Clamps	436
USA ,Bone Chisels	258	Canaliculus Knives	467
Bone Gouges	258	Lens Scoops	475
Bone Osteotomes	258	Sensibility Instruments	1
Dressing Forceps	95	WEBSTER ,Needle Holders	229
Perineum Scissors	62	Needle Holders TC	235
Plaster Spreaders	256	WECKER ,Iridectomy Scissors	65
Tissue Forceps	101	Iris Spatulas	473
Uterine,Curettes	399-404	WEISS ,Eye Speculas	459
Depressors	382	WEIL-BLAKESLEY ,Laminectomy Rongeurs	536
Dilators	379-381	Nasal Cutting Forceps	596
Elevating Forceps	389	WEITLANER ,Retractors	192,194
Hemostatic Forceps	406	WEITLANER-BABY ,Retractors	193
Polypus	388	WEITLANER-WULLSTEIN ,Retractors	192
Scissors	48-49	WELLS ,Enucleation Scoops	476
Scissors Super Cut	35	WERTHEIM ,Clamp Forceps	138,140
		Gynecological Scissors	49
		Peritoneal Clamp Forceps	138-139
		WERTHEIM-CULLEN ,Clamp Forceps	138
		WESSELEY-GRIESHABER ,Keratomes	466
		WEST ,Lachrymal Sac Chisels	483
		Lachrymal Sac Gouges	483
		Septum Chisels	605
		Septum Gouges	605
		Tampon Forceps	593
		WESTCOTT ,Iridectomy Scissors	68
		WESTMACOTT ,Tampon Forceps	593
		WHEELER ,Cataract Knives	464
		Cyclodialysis Spatulas	485
		WHITE ,Tonsil Forceps	623
		WHITEHEAD ,Mouth Gags	617
		WICKSTROEM ,Dissecting and Ligatur Forceps	133
		WIEN ,Ligature Catchers	254
		Nasal Speculas	591
		WIENER ,Iris Hooks	471
		Keratomes	466
		WILDE ,Ear Forceps	111
		WILDER ,Lachrymal Dilators	483
		Tongue Depressors	619
		WILLET-MARTELL ,Scalp Flap Forceps	407
		WILLIAMS ,Eye Speculas	461
		Intestinal Tissue Forceps	331
		WILLIGER ,Bone Curettes	268,271
		Elevators	282
		Mallets	320
		Periosteal Raspatories	275-276
		WILMER ,Eye Scissors	83
		WINTER ,Ovum Forceps	83
		Wire,Closure Forceps	576
		Cutting Pliers	315-316
		Cutting Pliers TC	316
		Cutting Scissors	87
		Cutting Scissors TC	64
		Guides	319
		Seizing Forceps	313-314
		Seizing Forceps TC	313
		Strainers For Extension Bows	318
		Twisting Forceps	319
		WITTNER ,Cervical Biopsy and Specimen Forceps	396
		WOLFF ,Lupus Curettes	329
		Plaster Cast Forceps	257
		WOODRUFF ,Ligature Needles	505

W

WOODSON ,Dissectors	518
WORTH ,Advancement Forceps	490
Wound and Nerve Hooks	150-151
Trachea Retractors	152-153,155-156
Vein Retractors	157
WRIGLEY ,Obstetrical Forceps	409
WULLSTEIN ,Micro Knives	578
WURZBURG ,Tongue Drepessors	616

Y

YANKAUER ,Elevators	282
Inhalers	14
Suction Tubes	11
Tonsil Elevators	622
YASARGIL ,Brain Suction Tube	9,13
Dissectors	542
Ligature Guides	543
Micro Forceps	113-114
Micro Needle Holders	220
Micro Raspatories	542
Micro Vessel Knives	541
Micro Scissors	70-71
Micro Scoops	542
Tumor Grasping Forceps	112-113
YASAR-NICOLA ,Pituitary Instruments	539
YEOMAN ,Biopsy Specimen Forceps	348
Rectal Biopsy Specimen	348
YOUNG ,Prostatic Retractors	360
Suture Instruments	249
Tongue Forceps	619

Z

ZAUFAL-JANSEN ,Bone Rongeur Forceps	300-303
ZAUFEL ,Foreign Body Instruments	586
ZENKER ,Dissecting and Ligature Forceps	128
Retractors	179
ZIEGLER ,Capsulotomy Knives	467-468
Cilia Forceps	110
Discission Knives	468
ZIELKE ,Bone Gouges	263
ZOLLINER ,Ear Speculas	565
Micro Instruments	583
ZWEIFEL ,Needle Holders TC	241
Pressure Clamps	137

10

Cat #	Pg #	Cat #	Pg #
10-01000-17	1	11-01160-16	8
10-01004-19	1	11-01164-19	8
10-01008-09	1	11-01168-11	8
10-01012-18	1	11-01172-11	8
10-01016-15	1	11-01176-03	8
10-01020-00	1	11-01176-04	8
10-01020-01	1	11-01176-05	8
10-01024-00	1		
10-01024-01	1		
10-01028-18	2		
10-01032-18	2		
10-01036-24	2		
10-01040-16	2	12-01180-06	9
10-01040-18	2	12-01180-07	9
10-01040-20	2	12-01180-08	9
10-01044-20	2	12-01180-09	9
10-01046-20	2	12-01180-10	9
10-01050-20	2	12-01180-11	9
10-01054-16	3	12-01180-12	9
10-01058-21	3	12-01180-15	9
10-01062-22	3	12-01184-06	9
10-01066-22	3	12-01184-07	9
10-01066-25	3	12-01184-08	9
10-01068-23	3	12-01184-09	9
10-01070-33	3	12-01184-10	9
10-01074-26	3	12-01184-11	9
10-01078-00	4	12-01184-12	9
10-01082-00	4	12-01184-15	9
10-01086-00	4	12-01192-13	9
10-01092-00	4	12-01192-15	9
10-01096-01	5	12-01192-18	9
10-01096-02	5	12-01192-22	9
10-01100-00	5	12-01193-13	9
10-01104-14	5	12-01193-15	9
10-01108-10	5	12-01193-18	9

12**11**

11-01112-30	6	12-01194-13	9
11-01112-35	6	12-01194-15	9
11-01112-40	6	12-01194-18	9
11-01112-45	6	12-01194-22	9
11-01112-50	6	12-01195-13	9
11-01112-55	6	12-01195-15	9
11-01112-60	6	12-01195-18	9
11-01116-30	6	12-01195-22	9
11-01116-35	6	12-01196-18	9
11-01116-40	6	12-01198-17	9
11-01116-45	6	12-01198-25	9
11-01116-50	6	12-01198-35	9
11-01116-55	6	12-01202-20	10
11-01116-60	6	12-01202-25	10
11-01120-30	6	12-01202-30	10
11-01120-35	6	12-01206-15	10
11-01120-40	6	12-01206-20	10
11-01120-45	6	12-01206-25	10
11-01120-50	6	12-01206-30	10
11-01120-55	6	12-01210-04	10
11-01124-03	6	12-01212-02	10
11-01124-04	6	12-01214-03	10
11-01128-03	6	12-01214-04	10
11-01128-04	6	12-01214-05	10
11-01128-06	6	12-01218-27	11
11-01132-16	7	12-01219-27	11
11-01136-19	7	12-01220-01	11
11-01140-16	7	12-01220-11	11
11-01144-24	7	12-01220-11	11
11-01148-07	8	12-01220-13	11
11-01148-09	8	12-01220-16	11
11-01148-10	8	12-01222-01	11
11-01148-12	8	12-01222-11	11
11-01152-40	8	12-01222-12	11
11-01152-46	8	12-01222-13	11
11-01152-55	8	12-01220-50	11
11-01152-65	8	12-01224-01	11
11-01156-15	8	12-01224-02	11
		12-01228-23	11
		12-01232-30	12
		12-01236-17	12
		12-01240-20	12
		12-01240-22	12
		12-01244-22	12
		12-01248-34	13
		12-01252-01	13

13

Cat #	Pg #	Cat #	Pg #
12-01252-02	13	13-01348-03	20
12-01252-03	13	13-01352-03	20
12-01252-04	13	13-01356-04	20
12-01252-05	13	13-01360-04	20
12-01252-06	13	13-01364-07	20
12-01252-60	13	13-01368-17	20
12-01256-01	13	13-01372-08	20
12-01256-02	13	13-01376-09	20
12-01256-03	13	13-01380-34	20
12-01262-30	13	13-01384-13	21
12-01266-00	13	13-01388-14	21
12-01272-01	14	13-01392-03	21
12-01272-02	14	13-01396-04	21
12-01276-01	14	13-01400-05	21
12-01276-02	14	13-01404-15	21
12-01280-15	14	13-01408-01	21
12-01280-20	14	13-01408-03	21
12-01280-25	14	13-01412-01	22
12-01284-01	14	13-01412-02	22
12-01284-02	14	13-01412-03	22
12-01288-01	14	13-01412-04	22
12-01288-02	14	13-01412-05	22
12-01288-03	14	13-01412-06	22
12-01292-00	15	13-01412-07	22
12-01292-01	15	13-01412-08	22
12-01292-02	15	13-01412-09	22
12-01292-03	15	13-01412-10	22
12-01292-04	15	13-01416-01	23
12-01292-05	15	13-01416-02	23
12-01292-06	15	13-01416-03	23
12-01292-07	15	13-01416-04	23
12-01292-08	15	13-01416-05	23
12-01296-01	15	13-01416-06	23
12-01296-02	15	13-01416-07	23
12-01296-03	15	13-01416-08	23
12-01296-04	15	13-01416-09	23
12-01296-05	15	13-01416-10	23
12-01296-06	15	13-01416-11	23
12-01296-07	15	13-01420-01	24
12-01296-08	15	13-01420-02	24
12-01300-01	15	13-01420-03	24
12-01300-02	15	13-01420-04	24
12-01300-03	15	13-01420-05	24
12-01304-01	15	13-01420-06	24
12-01304-02	15	13-01420-07	24
12-01304-03	15	13-01420-08	24
12-01308-01	15	13-01420-09	24
12-01308-02	15	13-01420-15	24
12-01308-03	15	13-01420-16	24
12-01312-18	15	13-01424-01	25
12-01312-20	15	13-01424-02	25
12-01316-30	16	13-01424-03	25
12-01316-40	16	13-01424-04	25
12-01316-10	16	13-01428-01	25
12-01316-11	16	13-01428-02	25
12-01316-12	16	13-01428-03	25
12-01316-13	16	13-01428-04	25
12-01316-14	16	13-01428-05	25
12-01320-30	17	13-01428-06	25
12-01320-40	17	13-01428-07	25
12-01320-11	17	13-01428-08	25
12-01320-12	17	13-01428-09	25
12-01320-13	17	13-01428-10	25
12-01320-14	17	13-01428-11	25
12-01324-30	18	13-01428-12	25
12-01324-40	18	13-01432-01	26
12-01324-11	18	13-01432-02	26
12-01324-12	18	13-01432-03	26
12-01324-13	18	13-01432-04	26
12-01324-14	18	13-01436-01	26
12-01328-20	19	13-01436-02	26
12-01328-10	19	13-01436-03	26
12-01328-11	19	13-01440-01	26
12-01332-00	19	13-01440-02	26
12-01336-00	19	13-01440-03	26
12-01340-00	19	13-01440-04	26
12-01344-00	19	13-01444-01	26

14

Cat #	Pg #	Cat #	Pg #
13-01444-02	26	14-01580-14	34
13-01448-13	27	14-01581-14	34
13-01448-16	27	14-01584-14	34
13-01448-19	27	14-01584-17	34
13-01448-22	27	14-01584-23	34
13-01452-17	27	14-01585-14	34
13-01452-20	27	14-01585-17	34
13-01456-16	27	14-01585-23	34
13-01456-19	27	14-01588-15	34
13-01456-22	27	14-01588-17	34
13-01460-12	27	14-01589-15	34
13-01464-09	27	14-01589-17	34
13-01468-11	27	14-01592-16	34
13-01472-01	28	14-01593-16	34
13-01472-02	28	14-01596-11	34
13-01476-16	28	14-01597-11	34
13-01476-20	28	14-01600-14	34
13-01476-24	28	14-01601-14	34
13-01476-28	28	14-01604-18	34
13-01480-11	28	14-01604-20	34
13-01480-12	28	14-01604-23	34
13-01480-17	28	14-01605-18	34
13-01484-11	28		
13-01488-08	28		
13-01492-09	29		
13-01496-19	29		
13-01500-01	29		
13-01504-01	29		
13-01508-09	30		
13-01509-09	30		
13-01512-11	30		
13-01516-13	30		
13-01520-18	30		
13-01524-14	31		
13-01528-22	31		
13-01532-13	31		
13-01536-28	31		
13-01537-28	31		
13-01540-06	31		
13-01544-07	31		
13-01548-01	31		
13-01552-13	32		
13-01556-13	32		
13-01560-24	32		
13-01564-06	32		
13-01568-01	32		
13-01568-02	32		
13-01568-03	32		
13-01568-04	32		
13-01568-05	32		
13-01568-06	32		
13-01572-00	33		
13-01576-00	33		
		14-01694-10	38
		14-01694-14	38
		14-01694-15	38
		14-01694-16	38
		14-01694-18	38
		14-01694-20	38
		14-01696-10	38
		14-01696-11	38
		14-01696-13	38
		14-01696-14	38
		14-01696-15	38
		14-01696-16	38
		14-01696-18	38
		14-01696-20	38
		14-01700-14	38
		14-01702-14	38
		14-01704-10	38
		14-01707-10	39
		14-01707-11	39
		14-01707-13	39
		14-01707-14	39
		14-01707-15	39
		14-01707-16	39
		14-01707-18	39
		14-01707-20	39
		14-01709-10	39
		14-01709-11	39
		14-01709-13	39
		14-01709-14	39
		14-01709-15	39

Cat #	Pg #	Cat #	Pg #	Cat #	Pg #	Cat #	Pg #	Cat #	Pg #	Cat #	Pg #
14-01709-16	39	14-01810-14	45	14-01865-18	48	14-01959-11	53	14-02103-15	60	14-02317-10	69
14-01709-18	39	14-01812-14	45	14-01865-20	48	14-01961-09	53	14-02107-18	60	14-02321-11	69
14-01709-20	39	14-01814-14	45	14-01865-23	48	14-01961-10	53	14-02111-17	60	14-02323-11	69
14-01711-10	39	14-01818-14	45	14-01865-25	48	14-01961-11	53	14-02115-17	60	14-02327-10	69
14-01711-11	39	14-01820-14	45	14-01865-28	48	14-01964-09	53	14-02118-18	60	14-02329-10	69
14-01711-13	39	14-01822-14	45	14-01865-30	48	14-01964-10	53	14-02119-18	60	14-02332-14	69
14-01711-14	39	14-01825-14	46	14-01867-18	48	14-01964-11	53	14-02123-17	60	14-02332-18	69
14-01711-15	39	14-01827-14	46	14-01867-20	48	14-01965-09	53	14-02125-17	60	14-02333-14	69
14-01711-16	39	14-01829-14	46	14-01867-23	48	14-01965-10	53	14-02129-19	61	14-02333-18	69
14-01711-18	39	14-01831-14	46	14-01867-25	48	14-01965-11	53	14-02133-30	61	14-02336-12	70
14-01711-20	39	14-01833-14	46	14-01867-28	48	14-01968-10	53	14-02137-27	61	14-02336-16	70
14-01715-14	39	14-01835-14	46	14-01867-30	48	14-01971-09	53	14-02142-21	61	14-02336-18	70
14-01717-14	39	14-01838-18	47	14-01869-18	48	14-01975-10	53	14-02146-21	61	14-02337-12	70
14-01719-14	39	14-01838-20	47	14-01869-20	48	14-01978-14	54	14-02150-21	61	14-02337-16	70
14-01722-13	40	14-01838-23	47	14-01869-23	48	14-01979-14	54	14-02153-13	62	14-02337-18	70
14-01722-14	40	14-01838-25	47	14-01869-25	48	14-01982-10	54	14-02153-16	62	14-02340-12	70
14-01724-13	40	14-01838-28	47	14-01869-28	48	14-01983-10	54	14-02157-16	62	14-02340-16	70
14-01724-14	40	14-01838-30	47	14-01869-30	48	14-01986-13	54	14-02160-10	62	14-02341-12	70
14-01727-13	40	14-01840-18	47	14-01870-20	49	14-01987-13	54	14-02163-14	62	14-02341-16	70
14-01727-14	40	14-01840-20	47	14-01870-23	49	14-01990-14	54	14-02165-22	62	14-02344-16	71
14-01729-13	40	14-01840-23	47	14-01872-20	49	14-01991-14	54	14-02169-23	62	14-02344-20	71
14-01729-14	40	14-01840-25	47	14-01872-23	49	14-01995-12	55	14-02171-23	62	14-02345-16	71
14-01732-14	40	14-01840-28	47	14-01874-20	49	14-01995-13	55	14-02175-18	63	14-02345-20	71
14-01733-14	40	14-01840-30	47	14-01874-23	49	14-01995-15	55	14-02177-19	63	14-02347-20	71
14-01736-15	40	14-01842-18	47	14-01877-20	49	14-01998-14	55	14-02181-18	63	14-02350-20	71
14-01737-15	40	14-01842-20	47	14-01877-23	49	14-02002-11	55	14-02185-13	63	14-02351-20	71
14-01740-16	41	14-01842-23	47	14-01879-20	49	14-02005-19	55	14-02189-13	63	14-02354-22	72
14-01741-16	41	14-01842-25	47	14-01879-23	49	14-02009-15	55	14-02191-13	63	14-02354-24	72
14-01744-16	41	14-01842-28	47	14-01881-20	49	14-02013-15	55	14-02195-16	63	14-02355-22	72
14-01745-16	41	14-01842-30	47	14-01881-23	49	14-02017-15	55	14-02199-19	63	14-02355-24	72
14-01748-16	41	14-01844-18	47	14-01883-20	49	14-02021-19	56	14-02202-22	64	14-02357-22	72
14-01749-16	41	14-01844-20	47	14-01883-23	49	14-02023-19	56	14-02203-22	64	14-02360-22	72
14-01752-16	41	14-01844-23	47	14-01887-14	49	14-02025-19	56	14-02207-22	64	14-02361-22	72
14-01753-16	41	14-01844-25	47	14-01887-19	49	14-02027-19	56	14-02211-15	64	14-02364-18	73
14-01756-13	42	14-01844-28	47	14-01887-22	49	14-02031-19	56	14-02215-12	64	14-02365-18	73
14-01756-14	42	14-01844-30	47	14-01892-27	50	14-02033-19	56	14-02218-13	64	14-02367-18	73
14-01760-15	42	14-01848-18	47	14-01893-27	50	14-02035-19	56	14-02219-13	64	14-02370-19	73
14-01763-14	42	14-01848-20	47	14-01896-16	50	14-02039-20	57	14-02222-01	65	14-02371-19	73
14-01767-14	42	14-01848-23	47	14-01896-18	50	14-02042-19	57	14-02222-02	65	14-02373-19	73
14-01771-18	42	14-01848-25	47	14-01897-16	50	14-02045-19	57	14-02222-03	65	14-02376-19	73
14-01775-14	42	14-01848-28	47	14-01897-18	50	14-02049-24	57	14-02225-12	65	14-02377-19	73
14-01778-14	43	14-01848-30	47	14-01898-10	50	14-02053-23	57	14-02229-01	65	14-02384-12	74
14-01778-15	43	14-01850-18	47	14-01900-18	50	14-02057-16	58	14-02229-02	65	14-02385-12	74
14-01778-17	43	14-01850-20	47	14-01901-16	50	14-02057-23	58	14-02233-05	65	14-02392-12	74
14-01778-19	43	14-01850-23	47	14-01901-18	50	14-02057-28	58	14-02236-09	65	14-02393-12	74
14-01778-23	43	14-01850-25	47	14-01904-12	51	14-02059-16	58	14-02238-09	65	14-02395-12	74
14-01779-14	43	14-01850-28	47	14-01906-12	51	14-02059-23	58	14-02240-09	65	14-02400-13	74
14-01779-15	43	14-01850-30	47	14-01908-12	51	14-02059-28	58	14-02243-09	65	14-02404-16	75
14-01779-17	43	14-01852-18	47	14-01911-12	51	14-02061-16	58	14-02245-09	65	14-02405-16	75
14-01779-19	43	14-01852-20	47	14-01913-12	51	14-02061-23	58	14-02247-09	65	14-02408-16	75
14-01779-23	43	14-01852-23	47	14-01915-12	51	14-02061-28	58	14-02250-08	66	14-02409-16	75
14-01782-14	43	14-01852-25	47	14-01916-12	51	14-02063-13	58	14-02253-08	66	14-02412-16	75
14-01782-17	43	14-01852-28	47	14-01918-12	51	14-02063-16	58	14-02255-08	66	14-02413-16	75
14-01782-23	43	14-01852-30	47	14-01920-12	51	14-02063-19	58	14-02257-08	66	14-02416-18	76
14-01783-14	43	14-01855-18	48	14-01922-12	51	14-02065-13	58	14-02260-08	66	14-02417-18	76
14-01783-17	43	14-01855-20	48	14-01923-12	51	14-02065-16	58	14-02263-08	66	14-02421-18	76
14-01783-23	43	14-01855-23	48	14-01925-12	51	14-02065-19	58	14-02265-08	66	14-02424-16	77
14-01786-15	43	14-01855-25	48	14-01927-12	51	14-02067-13	58	14-02267-08	66	14-02425-16	77
14-01786-17	43	14-01855-28	48	14-01929-12	51	14-02067-16	58	14-02270-10	67	14-02428-16	77
14-01786-19	43	14-01855-30	48	14-01932-12	51	14-02067-19	58	14-02271-10	67	14-02429-16	77
14-01786-21	43	14-01857-18	48	14-01933-12	51	14-02069-13	58	14-02273-10	67	14-02432-16	77
14-01787-15	43	14-01857-20	48	14-01936-14	52	14-02069-16	58	14-02275-10	67	14-02433-16	77
14-01787-17	43	14-01857-23	48	14-01937-14	52	14-02069-19	58	14-02277-10	67	14-02436-18	78
14-01787-19	43	14-01857-25	48	14-01940-15	52	14-02071-13	58	14-02281-10	67	14-02437-18	78
14-01787-21	43	14-01857-30	48	14-01940-18	52	14-02071-16	58	14-02283-10	67	14-02441-18	78
14-01790-15	43	14-01859-18	48	14-01941-15	52	14-02071-19	58	14-02285-10	67	14-02444-23	78
14-01790-17	43	14-01859-20	48	14-01941-18	52	14-02075-19	58	14-02287-10	67	14-02448-14	79
14-01791-15	43	14-01859-23	48	14-01945-15	52	14-02079-18	59	14-02291-10	68	14-02449-14	79
14-01791-17	43	14-01859-25	48	14-01948-12	52	14-02081-18	59	14-02293-10	68	14-02451-14	79
14-01794-17	44	14-01859-28	48	14-01951-12	52	14-02083-18	59	14-02295-10	68	14-02454-11	80
14-01795-17	44	14-01859-30	48	14-01953-12	52	14-02085-18	59	14-02297-10	68	14-02455-11	80
14-01798-11	44	14-01861-18	48	14-01955-12	52	14-02087-18	59	14-02301-10	68	14-02458-11	80
14-01799-11	44	14-01861-20	48	14-01958-09	53	14-02091-18	59	14-02303-10	68	14-02459-11	80
14-01802-14	44	14-01861-23	48	14-01958-10	53	14-02093-18	59	14-02307-11	68	14-02462-12	80
14-01803-14	44	14-01861-25	48	14-01958-11	53	14-02095-18	59	14-02309-11	68	14-02463-12	80
14-01806-14	44	14-01861-28	48	14-01959-09	53	14-02097-18	59	14-02311-11	68	14-02466-10	80
14-01807-14	44	14-01861-30	48	14-01959-10	53	14-02099-18	59	14-02315-10	69	14-02467-10	80

14

Cat #	Pg #	Cat #	Pg #	Cat #	Pg #	Cat #	Pg #	Cat #	Pg #	Cat #	Pg #
14-02470-10	80	14-02595-11	86	14-02765-11	93	15-02814-13	95	15-02952-13	100	15-03054-25	103
14-02471-10	80	14-02599-12	86	14-02768-11	94	15-02814-14	95	15-02952-14	100	15-03058-12	103
14-02474-10	80	14-02603-12	86	14-02769-11	94	15-02814-15	95	15-02952-15	100	15-03058-13	103
14-02475-10	80	14-02607-01	87	14-02772-11	94	15-02818-13	95	15-02952-16	100	15-03062-12	103
14-02478-11	80	14-02607-02	87	14-02773-11	94	15-02818-14	95	15-02952-18	100	15-03062-15	103
14-02479-11	80	14-02607-03	87	14-02777-11	94	15-02818-15	95	15-02952-20	100	15-03066-15	103
14-02482-09	81	14-02607-04	87	14-02780-09	94	15-02822-12	96	15-02952-25	100	15-03066-20	103
14-02482-10	81	14-02609-01	87	14-02780-10	94	15-02822-15	96	15-02952-30	100	15-03066-25	103
14-02482-11	81	14-02609-02	87	14-02781-09	94	15-02826-12	96	15-02956-14	100	15-03070-15	103
14-02483-09	81	14-02609-03	87	14-02781-10	94	15-02826-15	96	15-02956-16	100	15-03070-20	103
14-02483-10	81	14-02609-04	87	14-02784-09	94	15-02830-12	96	15-02956-18	100	15-03070-25	103
14-02483-11	81	14-02611-01	87	14-02784-10	94	15-02830-15	96	15-02956-20	100	15-03074-17	103
14-02485-09	81	14-02611-02	87	14-02785-09	94	15-02834-12	96	15-02956-25	100	15-03075-17	103
14-02485-10	81	14-02611-03	87	14-02785-10	94	15-02834-15	96	15-02956-30	100	15-03078-17	103
14-02485-11	81	14-02611-04	87			15-02838-12	96	15-02960-13	100	15-03079-17	103
14-02487-09	81	14-02615-17	87			15-02838-15	96	15-02960-14	100	15-03082-15	104
14-02487-10	81	14-02618-12	87			15-02842-15	96	15-02960-16	100	15-03082-18	104
14-02487-11	81	14-02622-10	87			15-02844-15	96	15-02960-18	100	15-03082-20	104
14-02492-10	81	14-02626-13	87	15-02788-10	95	15-02848-12	96	15-02960-20	100	15-03086-20	104
14-02492-11	81	14-02626-15	87	15-02788-11	95	15-02848-15	96	15-02960-25	100	15-03087-20	104
14-02493-10	81	14-02629-09	88	15-02788-13	95	15-02849-12	96	15-02960-30	100	15-03092-18	104
14-02493-11	81	14-02629-10	88	15-02788-14	95	15-02849-15	96	15-02964-13	100	15-03093-18	104
14-02496-09	81	14-02629-11	88	15-02788-15	95	15-02852-12	96	15-02964-14	100	15-03096-18	104
14-02496-10	81	14-02629-14	88	15-02788-16	95	15-02852-15	96	15-02964-16	100	15-03097-18	104
14-02496-11	81	14-02629-18	88	15-02788-18	95	15-02856-17	97	15-02968-13	100	15-04000-18	104
14-02497-09	81	14-02629-20	88	15-02788-20	95	15-02857-17	97	15-02968-14	100	15-04000-21	104
14-02497-10	81	14-02631-18	88	15-02788-25	95	15-02862-17	97	15-02968-16	100	15-04000-25	104
14-02497-11	81	14-02633-18	88	15-02788-30	95	15-02863-17	97	15-02972-13	100	15-04001-18	104
14-02500-09	82	14-02633-21	88	15-02789-11	95	15-02867-17	97	15-02972-14	100	15-04001-21	104
14-02500-10	82	14-02637-16	88	15-02789-13	95	15-02870-15	97	15-02972-16	100	15-04001-25	104
14-02500-11	82	14-02637-19	88	15-02789-14	95	15-02870-18	97	15-02972-18	100	15-04004-14	105
14-02501-09	82	14-02641-20	88	15-02789-16	95	15-02870-20	97	15-02972-20	100	15-04008-20	105
14-02501-10	82	14-02641-22	88	15-02789-18	95	15-02874-18	97	15-02972-25	100	15-04012-14	105
14-02501-11	82	14-02645-23	88	15-02789-20	95	15-02874-20	97	15-02976-12	101	15-04012-16	105
14-02504-10	82	14-02649-23	88	15-02789-25	95	15-02878-20	97	15-02976-13	101	15-04012-20	105
14-02505-10	82	14-02653-17	89	15-02789-30	95	15-02882-18	97	15-02976-14	101	15-04016-15	105
14-02508-10	82	14-02657-18	89	15-02792-14	95	15-02886-18	97	15-02976-15	101	15-04016-20	105
14-02508-11	82	14-02661-24	89	15-02792-16	95	15-02887-18	97	15-02976-18	101	15-04016-25	105
14-02509-10	82	14-02663-24	89	15-02792-18	95	15-02890-15	98	15-02976-21	101	15-04020-23	105
14-02509-11	82	14-02667-24	89	15-02792-20	95	15-02890-18	98	15-02976-25	101	15-04022-18	105
14-02512-10	82	14-02671-18	89	15-02792-25	95	15-02894-13	98	15-02976-31	101	15-04023-18	105
14-02512-11	82	14-02671-20	89	15-02796-11	95	15-02895-13	98	15-02980-12	101	15-04026-14	105
14-02513-10	82	14-02671-23	89	15-02796-13	95	15-02898-12	98	15-02980-13	101	15-04026-20	105
14-02513-11	82	14-02674-14	89	15-02796-14	95	15-02898-15	98	15-02980-14	101	15-04028-14	105
14-02516-08	82	14-02675-16	89	15-02796-16	95	15-02898-18	98	15-02980-18	101	15-04028-20	105
14-02517-08	82	14-02679-13	89	15-02796-18	95	15-02899-12	98	15-02980-21	101	15-04032-18	106
14-02520-10	83	14-02683-20	90	15-02796-20	95	15-02899-15	98	15-02980-25	101	15-04032-20	106
14-02521-10	83	14-02687-23	90	15-02796-25	95	15-02899-18	98	15-02980-31	101	15-04032-25	106
14-02524-11	83	14-02691-23	90	15-02796-30	95	15-02902-18	98	15-02984-14	101	15-04036-18	106
14-02525-11	83	14-02695-22	90	15-02797-11	95	15-02903-18	98	15-02988-13	101	15-04038-18	106
14-02528-11	83	14-02699-22	90	15-02797-13	95	15-02906-14	98	15-02988-14	101	15-04042-15	106
14-02529-11	83	14-02701-21	90	15-02797-14	95	15-02908-18	98	15-02988-15	101	15-04042-18	106
14-02532-11	83	14-02703-24	90	15-02797-16	95	15-02912-20	98	15-02992-15	101	15-04042-23	106
14-02533-11	83	14-02705-23	90	15-02797-18	95	15-02916-18	99	15-02996-15	101	15-04046-18	106
14-02536-11	84	14-02705-26	90	15-02797-20	95	15-02917-18	99	15-03000-13	101	15-04050-03	106
14-02536-13	84	14-02705-37	90	15-02797-25	95	15-02920-18	99	15-03000-15	101	15-04050-04	106
14-02537-11	84	14-02708-10	91	15-02797-30	95	15-02923-18	99	15-03004-12	102	15-04050-05	106
14-02537-13	84	14-02709-10	91	15-02802-13	95	15-02927-18	99	15-03004-15	102	15-04050-07	106
14-02541-21	84	14-02712-10	91	15-02802-15	95	15-02929-18	99	15-03008-12	102	15-04054-10	107
14-02543-21	84	14-02713-10	91	15-02802-17	95	15-02932-15	99	15-03008-15	102	15-04055-10	107
14-02547-14	84	14-02716-10	91	15-02802-20	95	15-02932-23	99	15-03012-12	102	15-04057-10	107
14-02547-17	84	14-02720-12	91	15-02806-11	95	15-02932-25	99	15-03012-15	102	15-04060-10	107
14-02551-22	84	14-02721-12	91	15-02806-13	95	15-02936-18	99	15-03016-12	102	15-04061-10	107
14-02553-22	84	14-02724-13	92	15-02806-14	95	15-02936-23	99	15-03020-13	102	15-04063-10	107
14-02555-17	84	14-02725-13	92	15-02806-15	95	15-02940-18	99	15-03020-15	102	15-04066-09	107
14-02559-14	85	14-02729-14	92	15-02806-16	95	15-02940-21	99	15-03024-12	102	15-04066-10	107
14-02563-09	85	14-02733-13	92	15-02806-18	95	15-02940-25	99	15-03024-15	102	15-04066-11	107
14-02565-10	85	14-02737-11	92	15-02806-20	95	15-02944-18	99	15-03028-12	102	15-04066-12	107
14-02565-12	85	14-02740-12	92	15-02810-12	95	15-02944-21	99	15-03028-15	102	15-04067-09	107
14-02567-11	85	14-02741-12	92	15-02810-13	95	15-02944-25	99	15-03032-12	102	15-04067-10	107
14-02567-16	85	14-02745-17	92	15-02810-14	95	15-02948-15	99	15-03036-12	102	15-04067-11	107
14-02571-09	85	14-02747-17	92	15-02810-15	95	15-02948-18	99	15-03040-12	102	15-04067-12	107
14-02575-12	85	14-02751-16	93	15-02810-18	95	15-02948-20	99	15-03041-12	102	15-04070-09	107
14-02579-11	85	14-02753-16	93	15-02810-21	95	15-02948-23	99	15-03046-15	103	15-04070-10	107
14-02583-11	85	14-02758-14	93	15-02810-25	95	15-02948-25	99	15-03050-15	103	15-04070-11	107
14-02587-15	86	14-02759-14	93	15-02810-30	95	15-02952-10	100	15-03054-15	103	15-04070-12	107
14-02591-10	86	14-02763-12	93	15-02814-12	95	15-02952-11	100	15-03054-20	103	15-04071-09	107

15

Cat #	Pg #	Cat #	Pg #	Cat #	Pg #	Cat #	Pg #	Cat #	Pg #	Cat #	Pg #
15-04071-10	107	15-04196-22	112	16-04302-12	117	16-04394-16	121	16-04495-22	126	16-04619-14	132
15-04071-11	107	15-04198-18	112	16-04303-10	117	16-04394-18	121	16-04495-24	126	16-04619-18	132
15-04071-12	107	15-04198-22	112	16-04303-12	117	16-04394-20	121	16-04497-19	126	16-04621-14	132
15-04074-07	108	15-04200-18	112	16-04306-10	117	16-04394-22	121	16-04497-22	126	16-04621-18	132
15-04074-09	108	15-04200-22	112	16-04306-12	117	16-04394-24	121	16-04497-24	126	16-04625-15	132
15-04074-11	108	15-04203-22	113	16-04307-10	117	16-04394-26	121	16-04499-19	126	16-04625-19	132
15-04078-10	108	15-04203-24	113	16-04307-12	117	16-04394-30	121	16-04499-22	126	16-04629-15	132
15-04079-10	108	15-04205-22	113	16-04310-13	117	16-04395-13	121	16-04499-24	126	16-04629-19	132
15-04082-10	108	15-04205-24	113	16-04311-13	117	16-04395-14	121	16-04502-24	127	16-04633-18	132
15-04083-10	108	15-04207-24	113	16-04315-12	118	16-04395-16	121	16-04503-24	127	16-04633-23	133
15-04087-11	108	15-04209-22	113	16-04318-18	118	16-04395-18	121	16-04507-22	127	16-04637-22	133
15-04090-13	108	15-04211-22	113	16-04318-21	118	16-04395-20	121	16-04507-23	127	16-04637-25	133
15-04091-13	108	15-04213-22	113	16-04319-18	118	16-04395-22	121	16-04507-24	127	16-04637-28	133
15-04094-13	108	15-04215-22	113	16-04319-21	118	16-04395-24	121	16-04511-18	127	16-04641-22	133
15-04095-13	108	15-04219-16	114	16-04322-18	118	16-04395-26	121	16-04511-24	127	16-04645-20	133
15-04098-15	108	15-04219-18	114	16-04322-21	118	16-04395-30	121	16-04515-19	127	16-04649-24	133
15-04099-15	108	15-04219-20	114	16-04323-18	118	16-04398-13	122	16-04515-24	127	16-04653-22	134
15-04102-14	109	15-04219-22	114	16-04323-21	118	16-04402-15	122	16-04515-26	127	16-04657-27	134
15-04106-12	109	15-04219-24	114	16-04326-14	118	16-04402-19	122	16-04519-23	128	16-04661-19	134
15-04108-12	109	15-04221-16	114	16-04327-14	118	16-04402-24	122	16-04521-23	128	16-04663-23	134
15-04111-12	109	15-04221-18	114	16-04330-16	118	16-04403-15	122	16-04523-23	128	16-04664-13	134
15-04115-12	109	15-04221-20	114	16-04331-16	118	16-04403-19	122	16-04525-23	128	16-04664-15	134
15-04118-09	109	15-04221-22	114	16-04334-14	119	16-04403-24	122	16-04527-23	128	16-04664-18	134
15-04121-10	109	15-04221-24	114	16-04335-14	119	16-04406-16	122	16-04531-20	128	16-04664-20	134
15-04124-07	109	15-04223-18	114	16-04338-16	119	16-04406-20	122	16-04534-29	128	16-04664-23	134
15-04128-08	110			16-04339-16	119	16-04407-16	122	16-04535-29	128	16-04665-13	134
15-04128-09	110			16-04342-14	119	16-04407-20	122	16-04537-29	128	16-04665-15	134
15-04132-09	110			16-04343-14	119	16-04410-12	122	16-04541-13	128	16-04665-18	134
15-04136-09	110			16-04346-14	119	16-04412-12	122	16-04545-18	129	16-04665-20	134
15-04140-09	110	16-04226-03	115	16-04347-14	119	16-04415-14	122	16-04547-20	129	16-04665-23	134
15-04144-10	110	16-04226-05	115	16-04350-16	119	16-04416-14	122	16-04549-21	129	16-04668-13	134
15-04145-10	110	16-04227-03	115	16-04351-16	119	16-04420-15	123	16-04551-21	129	16-04668-14	134
15-04148-10	110	16-04227-05	115	16-04354-14	119	16-04424-16	123	16-04553-24	129	16-04668-15	134
15-04154-16	111	16-04230-06	115	16-04355-14	119	16-04426-16	123	16-04557-18	129	16-04668-18	134
15-04154-20	111	16-04231-06	115	16-04358-14	120	16-04430-15	123	16-04559-20	129	16-04668-20	134
15-04154-24	111	16-04234-01	115	16-04359-14	120	16-04430-18	123	16-04561-21	129	16-04668-23	134
15-04154-30	111	16-04234-02	115	16-04362-16	120	16-04431-15	123	16-04563-21	129	16-04669-13	134
15-04156-16	111	16-04234-03	115	16-04363-16	120	16-04431-18	123	16-04567-21	130	16-04669-15	134
15-04156-20	111	16-04234-04	115	16-04367-16	120	16-04435-19	123	16-04567-27	130	16-04669-18	134
15-04156-24	111	16-04234-05	115	16-04370-15	120	16-04438-18	124	16-04569-21	130	16-04669-20	134
15-04156-30	111	16-04234-06	115	16-04371-15	120	16-04439-18	124	16-04569-27	130	16-04669-23	134
15-04158-16	111	16-04234-07	115	16-04374-15	120	16-04442-18	124	16-04571-21	130	16-04672-22	135
15-04158-20	111	16-04235-01	115	16-04375-15	120	16-04443-18	124	16-04571-27	130	16-04672-25	135
15-04158-24	111	16-04235-02	115	16-04378-14	120	16-04446-18	124	16-04573-21	130	16-04673-22	135
15-04158-30	111	16-04235-03	115	16-04379-14	120	16-04446-20	124	16-04573-27	130	16-04673-24	135
15-04160-16	111	16-04235-04	115	16-04382-13	121	16-04449-14	124	16-04575-21	130	16-04675-21	135
15-04160-20	111	16-04235-05	115	16-04382-16	121	16-04451-18	124	16-04575-27	130	16-04675-24	135
15-04160-24	111	16-04235-06	115	16-04382-16	121	16-04454-18	124	16-04577-21	130	16-04679-20	135
15-04160-30	111	16-04235-07	115	16-04383-13	121	16-04455-18	124	16-04577-27	130	16-04679-23	135
15-04161-16	111	16-04237-24	115	16-04383-14	121	16-04457-18	124	16-04579-21	130	16-04683-19	135
15-04161-20	111	16-04240-10	115	16-04383-16	121	16-04461-19	125	16-04579-27	130	16-04683-21	135
15-04161-24	111	16-04242-13	115	16-04386-13	121	16-04463-19	125	16-04581-21	130	16-04683-23	135
15-04161-30	111	16-04246-13	115	16-04386-14	121	16-04467-19	125	16-04584-20	130	16-04685-19	135
15-04164-12	111	16-04250-15	115	16-04386-16	121	16-04469-19	125	16-04585-20	130	16-04685-21	135
15-04164-15	111	16-04254-10	116	16-04387-13	121	16-04474-19	125	16-04587-20	130	16-04685-23	135
15-04167-11	111	16-04258-15	116	16-04387-14	121	16-04475-19	125	16-04589-20	130	16-04687-21	135
15-04167-12	111	16-04258-20	116	16-04387-16	121	16-04478-20	125	16-04591-20	130	16-04690-21	136
15-04167-15	111	16-04262-12	116	16-04390-13	121	16-04478-22	125	16-04595-27	131	16-04691-21	136
15-04167-18	111	16-04266-14	116	16-04390-14	121	16-04478-24	125	16-04598-21	131	16-04695-19	136
15-04171-12	111	16-04266-16	116	16-04390-16	121	16-04478-26	125	16-04598-27	131	16-04697-19	136
15-04175-14	111	16-04270-14	116	16-04390-18	121	16-04479-20	125	16-04599-21	131	16-04700-21	136
15-04177-14	111	16-04274-15	116	16-04390-20	121	16-04479-22	125	16-04599-27	131	16-04701-21	136
15-04181-16	111	16-04278-14	116	16-04390-22	121	16-04479-24	125	16-04602-21	131	16-04704-16	136
15-04181-18	111	16-04282-16	116	16-04390-24	121	16-04479-26	125	16-04602-27	131	16-04704-20	136
15-04181-20	111	16-04286-10	117	16-04390-26	121	16-04482-20	125	16-04603-21	131	16-04705-16	136
15-04183-16	111	16-04287-10	117	16-04390-30	121	16-04482-22	125	16-04603-27	131	16-04705-20	136
15-04183-18	111	16-04290-10	117	16-04391-13	121	16-04482-24	125	16-04607-18	131	16-04709-21	137
15-04183-20	111	16-04291-10	117	16-04391-14	121	16-04482-26	125	16-04611-13	131	16-04713-19	137
15-04187-03	112	16-04294-12	117	16-04391-16	121	16-04483-20	125	16-04711-18	131	16-04717-21	137
15-04187-05	112	16-04294-14	117	16-04391-18	121	16-04483-22	125	16-04611-20	131	16-04721-23	137
15-04189-03	112	16-04295-12	117	16-04391-20	121	16-04483-24	125	16-04611-23	131	16-04723-24	137
15-04189-05	112	16-04295-14	117	16-04391-22	121	16-04483-26	125	16-04611-25	131	16-04726-23	137
15-04191-03	112	16-04298-12	117	16-04391-24	121	16-04486-27	126	16-04611-27	131	16-04727-23	137
15-04191-05	112	16-04298-14	117	16-04391-26	121	16-04487-27	126	16-04615-18	132	16-04730-17	137
15-04194-16	112	16-04299-12	117	16-04391-30	121	16-04490-22	126	16-04615-22	132	16-04733-14	138
15-04194-22	112	16-04299-14	117	16-04394-13	121	16-04491-22	126	16-04615-25	132	16-04736-25	138
15-04196-16	112	16-04302-10	117	16-04394-14	121	16-04495-19	126	16-04615-28	132	16-04739-21	138

Cat #	Pg #	Cat #	Pg #	Cat #	Pg #	Cat #	Pg #	Cat #	Pg #	Cat #	Pg #
16-04743-24	138	16-04894-13	145	17-05006-16	151	17-05097-02	155	17-05214-01	160	17-05287-08	164
16-04747-25	139	16-04896-13	145	17-05010-08	151	17-05097-03	155	17-05214-02	160	17-05301-20	164
16-04751-23	139	16-04900-20	146	17-05010-10	151	17-05097-04	155	17-05218-00	160	17-05302-20	164
16-04753-23	139	16-04900-25	146	17-05010-12	151	17-05098-01	155	17-05218-01	160	17-05305-14	164
16-04755-22	139	16-04901-20	146	17-05010-14	151	17-05098-02	155	17-05218-02	160	17-05308-03	165
16-04757-22	139	16-04901-25	146	17-05010-16	151	17-05098-03	155	17-05218-03	160	17-05308-04	165
16-04761-22	139	16-04904-20	146	17-05010-18	151	17-05098-04	155	17-05222-13	160	17-05311-02	165
16-04765-18	140	16-04904-25	146	17-05014-12	151	17-05101-04	155	17-05224-14	160	17-05311-03	165
16-04769-14	140	16-04905-20	146	17-05014-14	151	17-05102-04	155	17-05228-19	160	17-05311-04	165
16-04773-18	140	16-04905-25	146	17-05014-16	151	17-05106-02	156	17-05232-21	160	17-05311-06	165
16-04773-20	140	16-04908-25	146	17-05014-18	151	17-05109-13	156	17-05236-13	160	17-05312-02	165
16-04777-20	140	16-04909-25	146	17-05017-16	151	17-05113-14	156	17-05240-18	160	17-05312-03	165
16-04781-18	140	16-04912-28	146	17-05018-16	151	17-05117-16	156	17-05244-16	161	17-05312-04	165
16-04785-18	141	16-04913-28	146	17-05021-16	151	17-05119-16	156	17-05248-12	161	17-05312-06	165
16-04789-20	141	16-04916-20	146	17-05023-16	151	17-05122-18	156	17-05250-15	161	17-05316-20	166
16-04791-20	141	16-04917-20	146	17-05025-16	151	17-05124-18	156	17-05254-16	161	17-05320-01	166
16-04794-24	141	16-04920-25	147	17-05029-16	151	17-05126-18	156	17-05256-15	161	17-05320-02	166
16-04795-24	141	16-04924-25	147	17-05031-16	151	17-05128-18	156	17-05260-19	161	17-05320-03	166
16-04799-20	141	16-04928-21	147	17-05035-16	151	17-05130-18	156	17-05263-22	162	17-05320-04	166
16-04801-20	141	16-04932-26	147	17-05037-16	151	17-05132-18	156	17-05264-22	162	17-05324-23	166
16-04805-20	141	16-04935-26	147	17-05040-10	152	17-05135-02	156	17-05267-23	162	17-05327-28	167
16-04808-09	142	16-04937-26	147	17-05040-17	152	17-05135-03	156	17-05268-23	162	17-05331-24	167
16-04812-05	142	16-04941-26	148	17-05040-20	152	17-05135-04	156	17-05273-01	162	17-05332-24	167
16-04812-09	142	16-04944-18	148	17-05040-22	152	17-05135-06	156	17-05273-02	162	17-05335-24	167
16-04816-09	142	16-04944-24	148	17-05043-01	152	17-05136-02	156	17-05273-03	162	17-05337-25	167
16-04820-09	142	16-04946-18	148	17-05043-02	152	17-05136-03	156	17-05273-04	162	17-05340-21	168
16-04820-11	142	16-04946-24	148	17-05043-03	152	17-05136-04	156	17-05273-06	162	17-05344-01	168
16-04820-13	142	16-04950-18	148	17-05043-04	152	17-05136-06	156	17-05273-08	162	17-05344-02	168
16-04820-15	142	16-04950-20	148	17-05044-01	152	17-05140-08	157	17-05274-01	162	17-05344-03	168
16-04824-11	142	16-04950-24	148	17-05044-02	152	17-05140-10	157	17-05274-02	162	17-05348-01	168
16-04824-13	142	16-04950-25	148	17-05044-03	152	17-05140-12	157	17-05274-03	162	17-05348-02	168
16-04825-14	142	16-04951-18	148	17-05044-04	152	17-05140-14	157	17-05274-04	162	17-05348-03	168
16-04832-10	142	16-04951-20	148	17-05047-02	152	17-05140-16	157	17-05274-06	162	17-05348-04	168
16-04832-13	142	16-04951-24	148	17-05047-03	152	17-05140-18	157	17-05274-08	162	17-05352-19	168
16-04836-10	143	16-04951-25	148	17-05047-04	152	17-05142-08	157	17-05275-01	162	17-05356-01	168
16-04836-15	143	16-04954-18	148	17-05048-02	152	17-05142-10	157	17-05275-02	162	17-05356-02	168
16-04840-10	143	16-04954-20	148	17-05048-03	152	17-05142-12	157	17-05275-03	162	17-05356-03	168
16-04840-13	143	16-04954-24	148	17-05048-04	152	17-05142-14	157	17-05275-04	162	17-05360-01	168
16-04844-16	143	16-04954-25	148	17-05051-04	152	17-05142-16	157	17-05275-06	162	17-05360-02	168
16-04848-20	143	16-04955-18	148	17-05052-04	152	17-05142-18	157	17-05275-08	162	17-05360-03	168
16-04852-18	143	16-04955-20	148	17-05055-03	153	17-05146-08	157	17-05279-01	163	17-05360-04	168
16-04856-14	144	16-04955-24	148	17-05057-05	153	17-05146-10	157	17-05279-02	163	17-05360-05	168
16-04856-15	144	16-04955-25	148	17-05059-07	153	17-05146-11	157	17-05279-03	163	17-05360-06	168
16-04856-18	144	16-04959-19	149	17-05063-15	153	17-05146-12	157	17-05279-04	163	17-05360-07	168
16-04856-20	144	16-04962-01	149	17-05065-15	153	17-05146-13	157	17-05279-06	163	17-05364-01	168
16-04860-14	144	16-04962-02	149	17-05069-11	153	17-05146-14	157	17-05280-01	163	17-05364-05	168
16-04864-16	144	16-04962-03	149	17-05072-17	153	17-05146-15	157	17-05280-02	163	17-05364-06	168
16-04864-18	144	16-04966-23	149	17-05076-17	153	17-05146-16	157	17-05280-03	163	17-05368-22	169
16-04868-15	144	16-04970-08	149	17-05080-08	154	17-05146-18	157	17-05280-04	163	17-05372-01	169
16-04868-18	144	16-04970-12	149	17-05080-11	154	17-05150-13	157	17-05280-06	163	17-05372-02	169
16-04868-20	144	16-04970-20	149	17-05080-15	154	17-05150-16	157	17-05281-01	163	17-05376-01	169
16-04872-50	144	16-04971-08	149	17-05080-17	154	17-05154-13	157	17-05281-02	163	17-05376-02	169
16-04872-60	144	16-04971-12	149	17-05080-20	154	17-05158-11	157	17-05281-03	163	17-05376-03	169
16-04872-70	144	16-04971-20	149	17-05080-23	154	17-05162-11	157	17-05281-04	163	17-05376-04	169
16-04872-80	144	16-04974-10	149	17-05082-08	154	17-05166-18	158	17-05281-06	163	17-05376-05	169
16-04876-13	144	16-04974-14	149	17-05082-11	154	17-05170-17	158	17-05285-24	163	17-05376-06	169
16-04876-17	144	16-04974-20	149	17-05082-15	154	17-05172-17	158	17-05287-21	163	17-05376-07	169
16-04876-20	144	16-04975-10	149	17-05082-17	154	17-05176-19	158	17-05288-21	163	17-05376-08	169
16-04876-25	144	16-04975-14	149	17-05082-20	154	17-05178-19	158	17-05291-21	163	17-05376-09	169
16-04876-30	144	16-04975-20	149	17-05082-23	154	17-05182-02	158	17-05292-21	163	17-05376-10	169
16-04880-13	144			17-05089-01	155	17-05182-03	158	17-05295-01	164	17-05380-21	169
16-04880-17	144			17-05089-02	155	17-05182-04	158	17-05295-02	164	17-05384-01	170
16-04880-20	144			17-05089-03	155	17-05186-20	158	17-05295-03	164	17-05384-02	170
16-04880-25	144	17-04979-13	150	17-05089-04	155	17-05190-16	159	17-05295-04	164	17-05384-03	170
16-04880-30	144	17-04980-13	150	17-05090-01	155	17-05192-16	159	17-05295-06	164	17-05384-04	170
16-04884-22	145	17-04984-20	150	17-05090-02	155	17-05195-16	159	17-05295-08	164	17-05384-05	170
16-04884-25	145	17-04988-19	150	17-05090-03	155	17-05196-16	159	17-05296-01	164	17-05388-01	170
16-04884-27	145	17-04988-28	150	17-05090-04	155	17-05200-16	159	17-05296-02	164	17-05388-02	170
16-04885-22	145	17-04990-19	150	17-05093-01	155	17-05204-15	159	17-05296-03	164	17-05388-03	170
16-04885-25	145	17-04990-28	150	17-05093-02	155	17-05206-15	159	17-05296-04	164	17-05388-04	170
16-04885-27	145	17-04993-15	150	17-05093-03	155	17-05209-01	159	17-05296-06	164	17-05392-01	170
16-04888-13	145	17-04995-18	150	17-05093-04	155	17-05209-02	159	17-05296-08	164	17-05392-02	170
16-04888-15	145	17-04997-18	150	17-05094-01	155	17-05209-03	159	17-05297-01	164	17-05392-03	170
16-04888-18	145	17-05001-13	150	17-05094-02	155	17-05210-01	159	17-05297-02	164	17-05392-04	170
16-04890-13	145	17-05001-18	150	17-05094-03	155	17-05210-02	159	17-05297-03	164	17-05392-05	170
16-04890-15	145	17-05002-13	150	17-05094-04	155	17-05210-03	159	17-05297-04	164	17-05392-06	170
16-04890-18	145	17-05002-18	150	17-05097-01	155	17-05214-00	160	17-05297-06	164	17-05396-29	171

Cat #	Pg #	Cat #	Pg #	Cat #	Pg #	Cat #	Pg #	Cat #	Pg #	Cat #	Pg #
17-05396-32	171	17-05500-01	176	17-05590-02	181	17-05759-10	191	17-05872-01	198	17-05968-01	206
17-05396-33	171	17-05500-02	176	17-05590-03	181	17-05760-10	191	17-05876-00	198	17-05968-02	206
17-05400-01	171	17-05500-03	176	17-05590-04	181	17-05763-10	191	17-05876-01	198	17-05972-00	206
17-05400-02	171	17-05502-26	176	17-05590-05	181	17-05764-10	191	17-05876-02	198	17-05972-01	206
17-05400-03	171	17-05506-01	177	17-05590-06	181	17-05767-10	191	17-05876-03	198	17-05972-02	206
17-05402-01	171	17-05506-02	177	17-05594-01	182	17-05768-10	191	17-05878-00	198	17-05972-03	206
17-05402-02	171	17-05508-01	177	17-05594-02	182	17-05772-11	191	17-05878-01	198	17-05972-04	206
17-05402-03	171	17-05508-02	177	17-05600-01	182	17-05774-11	191	17-05878-02	198	17-05972-05	206
17-05406-21	172	17-05510-27	177	17-05600-02	182	17-05777-13	191	17-05880-00	198	17-05976-00	207
17-05410-17	172	17-05512-27	177	17-05604-01	182	17-05778-13	191	17-05880-01	198	17-05976-01	207
17-05414-01	172	17-05516-02	177	17-05604-02	182	17-05781-10	192	17-05880-02	198	17-05976-02	207
17-05414-02	172	17-05516-03	177	17-05608-01	183	17-05781-13	192	17-05880-03	198	17-05976-03	207
17-05418-22	172	17-05520-25	177	17-05608-02	183	17-05781-14	192	17-05884-00	199	17-05976-04	207
17-05422-01	172	17-05524-01	178	17-05608-03	183	17-05781-16	192	17-05884-01	199	17-05976-05	207
17-05422-02	172	17-05524-02	178	17-05608-04	183	17-05782-10	192	17-05884-02	199	17-05976-10	207
17-05422-03	172	17-05524-03	178	17-05608-05	183	17-05782-13	192	17-05884-03	199	17-05980-00	207
17-05422-04	172	17-05524-04	178	17-05608-06	183	17-05782-14	192	17-05886-01	199	17-05980-01	207
17-05424-01	172	17-05524-05	178	17-05612-01	184	17-05782-16	192	17-05886-02	199	17-05980-02	207
17-05424-02	172	17-05524-06	178	17-05612-02	184	17-05785-13	192	17-05890-00	200	17-05980-03	207
17-05424-03	172	17-05524-07	178	17-05612-03	184	17-05785-14	192	17-05890-01	200	17-05980-04	207
17-05426-01	173	17-05524-08	178	17-05616-01	185	17-05785-16	192	17-05890-02	200	17-05980-05	207
17-05426-02	173	17-05524-09	178	17-05616-02	185	17-05786-13	192	17-05890-03	200	17-05980-06	207
17-05426-03	173	17-05528-01	178	17-05620-15	185	17-05786-14	192	17-05894-00	200	17-05980-10	207
17-05430-01	173	17-05528-02	178	17-05624-16	185	17-05786-16	192	17-05894-01	200	17-05984-00	207
17-05430-02	173	17-05528-03	178	17-05627-10	186	17-05789-13	192	17-05894-02	200	17-05984-01	207
17-05430-03	173	17-05528-04	178	17-05627-20	186	17-05789-14	192	17-05894-03	200	17-05984-02	207
17-05430-04	173	17-05532-01	178	17-05629-17	186	17-05789-16	192	17-05898-16	200	17-05984-10	207
17-05434-00	173	17-05532-02	178	17-05632-17	186	17-05790-13	192	17-05902-09	200	17-05988-00	208
17-05434-01	173	17-05532-03	178	17-05636-21	186	17-05790-14	192	17-05902-11	200	17-05988-01	208
17-05434-02	173	17-05532-04	178	17-05640-18	186	17-05790-16	192	17-05902-13	200	17-05988-02	208
17-05438-01	173	17-05536-01	179	17-05644-01	186	17-05793-15	192	17-05902-19	200	17-05988-10	208
17-05438-02	173	17-05536-02	179	17-05644-02	186	17-05796-16	192	17-05904-19	200	17-05990-00	208
17-05438-03	173	17-05536-03	179	17-05648-00	186	17-05800-12	192	17-05908-01	200	17-05994-00	208
17-05438-04	173	17-05540-01	179	17-05652-21	187	17-05803-16	193	17-05908-02	200	17-05994-01	208
17-05442-01	174	17-05540-02	179	17-05658-20	187	17-05804-16	193	17-05908-03	200	17-05994-02	208
17-05442-02	174	17-05540-03	179	17-05662-17	187	17-05805-19	193	17-05908-04	200	17-05994-03	208
17-05442-03	174	17-05544-00	179	17-05668-05	187	17-05805-25	193	17-05912-18	201	17-05998-01	209
17-05446-04	174	17-05544-01	179	17-05668-07	187	17-05805-32	193	17-05914-18	201	17-05998-02	209
17-05450-01	174	17-05544-02	179	17-05668-09	187	17-05808-13	193	17-05918-19	201	17-05998-03	209
17-05454-01	174	17-05548-01	179	17-05672-06	187	17-05811-13	193	17-05922-12	201	17-05998-04	209
17-05454-02	174	17-05548-02	179	17-05672-07	187	17-05812-13	193	17-05922-17	201	17-05998-10	209
17-05454-03	174	17-05548-03	179	17-05672-09	187	17-05815-13	193	17-05926-00	201	17-05999-00	209
17-05454-04	174	17-05552-33	179	17-05672-11	187	17-05815-16	193	17-05928-01	201	17-06000-01	209
17-05458-01	175	17-05556-28	179	17-05676-18	187	17-05816-13	193	17-05928-02	201	17-06000-02	209
17-05458-02	175	17-05560-20	180	17-05680-23	187	17-05816-16	193	17-05932-00	202	17-06000-03	209
17-05458-03	175	17-05560-30	180	17-05686-10	188	17-05819-20	194	17-05932-01	202	17-06000-04	209
17-05458-04	175	17-05560-40	180	17-05687-10	188	17-05819-25	194	17-05932-02	202		
17-05458-05	175	17-05564-01	180	17-05690-01	188	17-05820-20	194	17-05936-00	202	18	
17-05462-25	175	17-05564-02	180	17-05690-02	188	17-05820-25	194	17-05940-00	202	18-06004-11	210
17-05466-01	175	17-05568-01	180	17-05694-07	188	17-05821-25	194	17-05944-00	203	18-06004-13	210
17-05466-02	175	17-05568-02	180	17-05694-10	188	17-05822-25	194	17-05944-01	203	18-06004-14	210
17-05466-03	175	17-05568-03	180	17-05698-02	188	17-05823-20	194	17-05944-02	203	18-06004-16	210
17-05466-04	175	17-05568-04	180	17-05698-04	188	17-05823-26	194	17-05944-03	203	18-06004-18	210
17-05466-05	175	17-05568-05	180	17-05702-16	188	17-05824-20	194	17-05944-04	203	18-06004-20	210
17-05466-06	175	17-05568-06	180	17-05706-21	188	17-05824-26	194	17-05948-00	203	18-06004-25	210
17-05470-22	175	17-05568-07	180	17-05708-21	188	17-05827-20	194	17-05948-01	203	18-06006-11	210
17-05472-01	175	17-05568-08	180	17-05712-30	189	17-05828-20	194	17-05948-02	203	18-06006-13	210
17-05472-02	175	17-05568-09	180	17-05716-29	189	17-05831-20	194	17-05948-03	203	18-06006-14	210
17-05472-03	175	17-05568-10	180	17-05720-14	189	17-05831-26	194	17-05948-04	203	18-06006-16	210
17-05476-23	175	17-05572-01	180	17-05722-23	189	17-05832-20	194	17-05948-05	203	18-06006-18	210
17-05480-01	175	17-05572-02	180	17-05724-18	189	17-05832-26	194	17-05948-06	203	18-06006-20	210
17-05480-02	175	17-05572-03	180	17-05726-15	189	17-05836-21	195	17-05948-07	203	18-06006-25	210
17-05484-28	176	17-05572-04	180	17-05728-18	189	17-05839-01	195	17-05948-08	203	18-06008-11	210
17-05488-26	176	17-05572-05	180	17-05732-14	189	17-05839-02	195	17-05948-09	203	18-06008-13	210
17-05492-01	176	17-05572-06	180	17-05736-07	190	17-05840-01	195	17-05948-10	203	18-06008-14	210
17-05492-02	176	17-05572-07	180	17-05739-05	190	17-05840-02	195	17-05952-01	204	18-06008-16	210
17-05492-03	176	17-05572-08	180	17-05739-07	190	17-05843-27	195	17-05952-02	204	18-06008-18	210
17-05492-04	176	17-05574-01	180	17-05740-05	190	17-05844-27	195	17-05956-00	204	18-06008-20	210
17-05492-05	176	17-05574-02	180	17-05740-07	190	17-05847-27	195	17-05956-01	204	18-06008-25	210
17-05492-06	176	17-05574-03	180	17-05743-07	190	17-05848-27	196	17-05956-02	204	18-06010-14	210
17-05492-07	176	17-05578-28	180	17-05746-08	190	17-05851-31	196	17-05960-00	205	18-06010-16	210
17-05496-01	176	17-05582-01	181	17-05746-11	190	17-05852-31	196	17-05960-01	205	18-06012-11	210
17-05496-02	176	17-05582-02	181	17-05750-09	190	17-05856-33	196	17-05960-02	205	18-06012-13	210
17-05496-03	176	17-05586-01	181	17-05753-07	190	17-05861-27	196	17-05964-00	205	18-06012-14	210
17-05496-04	176	17-05586-02	181	17-05753-10	190	17-05864-33	197	17-05964-01	205	18-06012-16	210
17-05496-05	176	17-05586-03	181	17-05756-07	190	17-05868-00	197	17-05964-02	205	18-06012-18	210
17-05496-06	176	17-05590-01	181	17-05756-10	190	17-05872-00	197	17-05968-00	206	18-06012-20	210

18

Cat #	Pg #	Cat #	Pg #	Cat #	Pg #	Cat #	Pg #	Cat #	Pg #	Cat #	Pg #
18-06016-13	210	18-06116-06	214	19-06219-23	222	19-06342-26	230	19-06476-31	236	19-06607-14	243
18-06016-18	210	18-06116-09	214	19-06222-18	223	19-06342-30	230	19-06480-15	237	19-06609-16	243
18-06020-14	210	18-06116-12	214	19-06222-21	223	19-06343-16	230	19-06484-15	237	19-06612-01	244
18-06020-18	210	18-06116-15	214	19-06222-23	223	19-06343-18	230	19-06488-15	237	19-06612-02	244
18-06024-11	210	18-06120-00	215	19-06223-18	223	19-06343-20	230	19-06492-18	237	19-06617-01	244
18-06024-13	210	18-06120-02	215	19-06223-21	223	19-06343-24	230	19-06492-20	237	19-06617-02	244
18-06024-14	210	18-06120-03	215	19-06223-23	223	19-06343-26	230	19-06492-23	237	19-06622-01	244
18-06024-16	210	18-06120-04	215	19-06226-12	224	19-06343-30	230	19-06492-26	237	19-06622-02	244
18-06024-18	210	18-06120-06	215	19-06227-12	224	19-06347-21	230	19-06492-31	237	19-06627-01	244
18-06024-20	210	18-06120-07	215	19-06229-12	224	19-06350-16	230	19-06496-13	237	19-06627-02	244
18-06025-14	210	18-06120-08	215	19-06232-12	224	19-06350-18	230	19-06498-16	237	19-06632-01	245
18-06028-13	210	18-06120-10	215	19-06233-12	224	19-06350-20	230	19-06502-12	237	19-06632-02	245
18-06028-14	210	18-06120-12	215	19-06235-12	224	19-06354-16	230	19-06506-13	237	19-06637-01	245
18-06028-16	210	18-06120-14	215	19-06238-14	225	19-06354-18	230	19-06510-14	238	19-06637-02	245
18-06028-18	210	18-06124-40	215	19-06239-14	225	19-06354-20	230	19-06510-18	238	19-06642-01	245
18-06032-13	210	18-06124-50	215	19-06242-13	225	19-06358-17	231	19-06510-20	238	19-06642-02	245
18-06032-14	210	18-06124-65	215	19-06242-15	225	19-06362-18	231	19-06510-23	238	19-06648-01	246
18-06032-16	210	18-06124-80	215	19-06246-14	225	19-06362-26	231	19-06514-13	238	19-06648-02	246
18-06032-20	210	18-06128-03	215	19-06248-13	225	19-06365-27	231	19-06514-15	238	19-06653-01	246
18-06033-16	210	18-06128-04	215	19-06250-14	225	19-06368-27	231	19-06514-18	238	19-06653-02	246
18-06036-10	210	18-06128-05	215	19-06254-12	226	19-06372-23	231	19-06514-20	238	19-06658-01	246
18-06040-16	210	18-06128-06	215	19-06255-12	226	19-06376-27	231	19-06514-23	238	19-06658-02	246
18-06044-25	211	18-06132-18	215	19-06258-12	226	19-06380-15	232	19-06514-26	238	19-06664-01	247
18-06044-30	211	18-06132-21	215	19-06259-12	226	19-06384-15	232	19-06516-13	238	19-06664-02	247
18-06044-40	211	18-06136-14	215	19-06262-13	226	19-06388-18	232	19-06516-15	238	19-06664-03	247
18-06048-13	211	18-06136-24	215	19-06266-12	226	19-06392-17	232	19-06516-18	238	19-06672-01	247
18-06048-14	211			19-06270-16	226	19-06392-20	232	19-06516-20	238	19-06672-02	247
18-06052-23	211			19-06271-16	226	19-06396-11	232	19-06516-23	238	19-06677-01	247
18-06054-28	211			19-06274-14	227	19-06398-14	232	19-06516-26	238	19-06677-02	247
18-06058-16	211			19-06274-18	227	19-06398-18	232	19-06520-15	238	19-06685-01	247
18-06062-01	211	19-06140-14	216	19-06274-21	227	19-06400-17	232	19-06520-17	238	19-06685-02	247
18-06062-02	211	19-06141-14	216	19-06275-14	227	19-06404-14	233	19-06520-20	238	19-06690-32	248
18-06062-03	211	19-06144-14	216	19-06275-18	227	19-06406-16	233	19-06524-18	238	19-06694-21	248
18-06062-04	211	19-06144-18	216	19-06275-21	227	19-06408-14	233	19-06524-20	238	19-06698-20	248
18-06070-01	211	19-06145-14	216	19-06278-14	227	19-06412-15	233	19-06528-26	239	19-06702-19	248
18-06070-02	211	19-06145-18	216	19-06278-18	227	19-06416-18	233	19-06532-27	239	19-06705-01	249
18-06070-03	211	19-06148-09	216	19-06278-21	227	19-06420-20	233	19-06534-27	239	19-06705-02	249
18-06074-12	212	19-06149-09	216	19-06279-14	227	19-06424-18	233	19-06537-20	239	19-06705-03	249
18-06074-16	212	19-06152-14	216	19-06279-18	227	19-06428-14	234	19-06537-27	239	19-06705-21	249
18-06074-18	212	19-06153-14	216	19-06279-21	227	19-06428-17	234	19-06540-14	240	19-06707-25	249
18-06075-18	212	19-06156-09	217	19-06282-14	227	19-06428-20	234	19-06540-17	240	19-06711-01	249
18-06076-18	212	19-06157-09	217	19-06284-14	227	19-06430-14	234	19-06540-20	240	19-06711-02	249
18-06078-16	212	19-06160-14	217	19-06288-14	227	19-06430-17	234	19-06540-24	240	19-06711-03	249
18-06080-13	212	19-06161-14	217	19-06292-13	227	19-06430-20	234	19-06542-14	240	19-06711-04	249
18-06080-18	212	19-06164-11	217	19-06296-18	227	19-06434-14	235	19-06542-17	240	19-06715-01	250
18-06084-14	212	19-06168-18	217	19-06298-18	227	19-06434-17	235	19-06542-20	240	19-06715-02	250
18-06084-16	212	19-06168-21	217	19-06302-14	228	19-06434-20	235	19-06542-24	240	19-06715-03	250
18-06086-14	212	19-06170-18	217	19-06303-14	228	19-06438-13	235	19-06544-17	240	19-06715-04	250
18-06086-16	212	19-06170-21	217	19-06306-14	228	19-06440-13	235	19-06544-20	240	19-06717-01	250
18-06090-12	212	19-06174-20	218	19-06306-18	228	19-06444-13	235	19-06548-16	240	19-06717-02	250
18-06090-14	212	19-06174-22	218	19-06306-23	228	19-06448-12	235	19-06548-18	240	19-06717-03	250
18-06090-16	212	19-06175-16	218	19-06310-16	228	19-06452-18	235	19-06548-20	240	19-06717-04	250
18-06090-18	212	19-06175-20	218	19-06310-18	228	19-06456-20	235	19-06650-18	240	19-06720-25	251
18-06092-12	212	19-06175-22	218	19-06310-20	228	19-06456-24	235	19-06650-20	240	19-06724-22	251
18-06092-14	212	19-06175-24	218	19-06310-23	228	19-06456-26	235	19-06654-20	240	19-06726-22	251
18-06092-16	212	19-06178-16	218	19-06310-25	228	19-06460-16	236	19-06558-18	241	19-06730-24	251
18-06092-18	212	19-06178-18	218	19-06311-16	228	19-06460-16	236	19-06562-14	241	19-06734-01	252
18-06094-12	212	19-06179-16	218	19-06311-18	228	19-06460-18	236	19-06562-17	241	19-06734-02	252
18-06094-14	212	19-06179-18	218	19-06311-20	228	19-06460-20	236	19-06562-20	241	19-06734-03	252
18-06094-16	212	19-06182-15	219	19-06311-23	228	19-06460-24	236	19-06566-18	241	19-06734-04	252
18-06094-18	212	19-06183-15	219	19-06311-25	228	19-06460-26	236	19-06570-20	241	19-06738-01	252
18-06098-28	213	19-06186-18	219	19-06314-13	229	19-06460-30	236	19-06570-23	241	19-06738-02	252
18-06098-38	213	19-06187-18	219	19-06315-13	229	19-06461-20	236	19-06574-20	242	19-06738-03	252
18-06100-28	213	19-06190-18	219	19-06318-13	229	19-06461-24	236	19-06574-25	242	19-06738-04	252
18-06100-38	213	19-06194-18	220	19-06322-12	229	19-06461-26	236	19-06578-20	242	19-06742-25	252
18-06104-36	213	19-06194-22	220	19-06324-12	229	19-06464-14	236	19-06578-24	242	19-06746-28	252
18-06108-01	213	19-06195-18	220	19-06326-12	229	19-06470-20	236	19-06582-17	242	19-06750-18	253
18-06108-02	213	19-06195-22	220	19-06330-14	229	19-06470-24	236	19-06582-20	242	19-06750-27	253
18-06108-03	213	19-06198-15	221	19-06334-13	229	19-06474-18	236	19-06586-16	242	19-06754-19	253
18-06112-00	214	19-06199-15	221	19-06334-18	229	19-06474-20	236	19-06586-16	242	19-06756-19	253
18-06112-01	214	19-06206-15	221	19-06338-18	229	19-06474-23	236	19-06590-12	242	19-06760-19	254
18-06112-02	214	19-06207-15	221	19-06342-13	230	19-06474-26	236	19-06594-20	242	19-06762-19	254
18-06112-03	214	19-06210-18	222	19-06342-14	230	19-06474-31	236	19-06594-25	242	19-06764-20	254
18-06112-06	214	19-06211-18	222	19-06342-16	230	19-06476-18	236	19-06598-11	243	19-06768-23	254
18-06112-09	214	19-06214-18	222	19-06342-18	230	19-06476-20	236	19-06600-14	243	19-06772-21	254
18-06112-12	214	19-06215-18	222	19-06342-20	230	19-06476-23	236	19-06602-17	243	19-06776-23	254
18-06112-15	214	19-06218-23	222	19-06342-24	230	19-06476-26	236	19-06604-18	243	19-06780-12	255

19

Cat #	Pg #	Cat #	Pg #	Cat #	Pg #	Cat #	Pg #	Cat #	Pg #	Cat #	Pg #
19-06782-12	255	21-06874-12	258	21-06915-16	260	21-06938-10	261	21-06966-06	263	21-06993-04	266
19-06786-12	255	21-06874-14	258	21-06915-19	260	21-06938-15	261	21-06966-09	263	21-06993-05	266
19-06788-12	255	21-06874-16	258	21-06915-25	260	21-06938-20	261	21-06966-13	263	21-06993-06	266
19-06790-13	255	21-06878-06	258	21-06915-32	260	21-06938-25	261	21-06966-16	263	21-06993-10	266
19-06792-13	255	21-06878-12	258	21-06918-06	260	21-06938-30	261	21-06966-19	263	21-06993-20	266
19-06796-12	255	21-06878-18	258	21-06918-09	260	21-06942-20	262	21-06966-25	263	21-06993-30	266
19-06798-12	255	21-06880-06	258	21-06918-14	260	21-06943-20	262	21-06966-32	263	21-06996-01	267
19-06802-14	255	21-06880-12	258	21-06918-16	260	21-06944-22	262	21-06967-06	263	21-06996-02	267
19-06806-14	255	21-06880-18	258	21-06918-19	260	21-06948-05	263	21-06967-09	263	21-06996-03	267
19-06810-17	255	21-06882-06	258	21-06918-25	260	21-06948-09	263	21-06967-13	263	21-06996-04	267
19-06812-17	255	21-06882-12	258	21-06918-32	260	21-06950-06	263	21-06967-16	263	21-06996-05	267

20

20-06816-20	256	21-06882-16	258	21-06919-09	260	21-06950-08	263	21-06967-19	263	21-06996-06	267
20-06820-18	256	21-06882-18	258	21-06919-14	260	21-06950-10	263	21-06967-25	263	21-06996-10	267
20-06824-18	256	21-06886-03	258	21-06919-16	260	21-06950-12	263	21-06967-32	263	21-06996-20	267
20-06828-14	256	21-06886-05	258	21-06919-25	260	21-06950-15	263	21-06970-05	264	21-06996-30	267
20-06832-28	256	21-06886-07	258	21-06919-32	260	21-06950-20	263	21-06970-10	264	21-06998-01	267
20-06836-30	256	21-06886-09	258	21-06922-04	261	21-06950-25	263	21-06970-15	264	21-06998-02	267
20-06840-28	256	21-06890-02	258	21-06922-06	261	21-06950-30	263	21-06972-05	264	21-06998-03	267
20-06844-23	256	21-06890-03	258	21-06922-08	261	21-06952-06	263	21-06972-10	264	21-06998-04	267
20-06848-18	257	21-06893-10	259	21-06922-10	261	21-06952-08	263	21-06972-15	264	21-06998-05	267
20-06848-24	257	21-06893-15	259	21-06922-13	261	21-06952-10	263	21-06973-05	264	21-06998-06	267
20-06852-24	257	21-06893-20	259	21-06922-16	261	21-06952-12	263	21-06973-10	264	21-06998-10	267
20-06856-23	257	21-06893-25	259	21-06922-18	261	21-06952-15	263	21-06973-15	264	21-06998-20	267
20-06856-26	257	21-06893-30	259	21-06922-20	261	21-06952-20	263	21-06976-01	264	21-06998-30	267
20-06856-37	257	21-06895-10	259	21-06922-25	261	21-06952-25	263	21-06977-02	264	21-07002-02	267
		21-06895-15	259	21-06922-30	261	21-06952-30	263	21-06977-03	264	21-07002-03	267
		21-06895-20	259	21-06922-38	261	21-06953-06	263	21-06977-04	264	21-07002-04	267
		21-06895-25	259	21-06922-44	261	21-06953-08	263	21-06980-01	265	21-07002-05	267
		21-06895-30	259	21-06922-50	261	21-06953-10	263	21-06980-02	265	21-07002-06	267
		21-06898-05	259	21-06923-04	261	21-06953-12	263	21-06980-03	265	21-07002-07	267
		21-06898-06	259	21-06923-06	261	21-06953-15	263	21-06980-04	265	21-07002-08	267
		21-06898-07	259	21-06923-08	261	21-06953-20	263	21-06980-05	265	21-07002-10	267
		21-06898-08	259	21-06923-10	261	21-06953-25	263	21-06980-06	265	21-07002-12	267
		21-06898-10	259	21-06923-13	261	21-06953-30	263	21-06980-10	265	21-07002-14	267
		21-06898-15	259	21-06923-16	261	21-06956-06	263	21-06980-20	265	21-07004-02	267
		21-06900-05	259	21-06923-18	261	21-06953-08	263	21-06980-30	265	21-07004-03	267
		21-06900-06	259	21-06923-20	261	21-06953-10	263	21-06980-40	265	21-07004-04	267
		21-06900-07	259	21-06923-25	261	21-06953-12	263	21-06984-01	265	21-07004-05	267
		21-06900-08	259	21-06923-30	261	21-06953-15	263	21-06984-02	265	21-07004-06	267
		21-06900-10	259	21-06923-38	261	21-06953-20	263	21-06984-03	265	21-07004-07	267
		21-06900-15	259	21-06923-44	261	21-06953-25	263	21-06984-04	265	21-07004-08	267
		21-06904-04	260	21-06923-50	261	21-06953-30	263	21-06984-05	265	21-07004-10	267
		21-06904-06	260	21-06926-02	261	21-06956-06	263	21-06984-06	265	21-07004-12	267
		21-06904-08	260	21-06926-03	261	21-06956-08	263	21-06984-10	265	21-07004-14	267
		21-06904-10	260	21-06926-04	261	21-06956-10	263	21-06984-20	265	21-07008-01	268
		21-06904-12	260	21-06926-06	261	21-06956-15	263	21-06984-30	265	21-07008-02	268
		21-06904-14	260	21-06926-08	261	21-06956-20	263	21-06984-40	265	21-07008-03	268
		21-06906-04	260	21-06926-10	261	21-06956-25	263	21-06988-01	266	21-07008-04	268
		21-06906-06	260	21-06926-12	261	21-06956-30	263	21-06988-02	266	21-07008-10	268
		21-06906-08	260	21-06926-15	261	21-06957-06	263	21-06988-03	266	21-07008-20	268
		21-06906-10	260	21-06927-02	261	21-06957-08	263	21-06988-04	266	21-07008-30	268
		21-06906-12	260	21-06927-03	261	21-06957-10	263	21-06988-05	266	21-07012-01	268
		21-06906-14	260	21-06923-04	261	21-06957-15	263	21-06988-06	266	21-07012-02	268
		21-06910-02	260	21-06923-06	261	21-06957-20	263	21-06988-10	266	21-07012-10	268
		21-06910-03	260	21-06923-08	261	21-06957-25	263	21-06988-20	266	21-07012-20	268
		21-06910-04	260	21-06923-10	261	21-06957-30	263	21-06988-30	266	21-07014-01	268
		21-06910-05	260	21-06923-12	261	21-06960-06	263	21-06990-01	266	21-07014-02	268
		21-06910-06	260	21-06923-15	261	21-06960-09	263	21-06990-02	266	21-07014-10	268
		21-06910-07	260	21-06930-04	261	21-06960-13	263	21-06990-03	266	21-07014-20	268
		21-06910-08	260	21-06930-06	261	21-06960-16	263	21-06990-04	266	21-07017-01	268
		21-06911-02	260	21-06930-08	261	21-06960-19	263	21-06990-05	266	21-07017-02	268
		21-06911-03	260	21-06930-10	261	21-06960-25	263	21-06990-06	266	21-07018-01	269
		21-06911-04	260	21-06930-12	261	21-06960-32	263	21-06990-10	266	21-07018-02	269
		21-06911-05	260	21-06932-04	261	21-06961-06	263	21-06990-20	266	21-07018-03	269
		21-06911-06	260	21-06932-06	261	21-06961-09	263	21-06990-30	266	21-07018-10	269
		21-06911-07	260	21-06932-08	261	21-06961-13	263	21-06991-01	266	21-07020-01	269
		21-06911-08	260	21-06932-10	261	21-06961-16	263	21-06991-02	266	21-07020-02	269
		21-06914-06	260	21-06932-12	261	21-06961-19	263	21-06991-03	266	21-07020-03	269
		21-06914-09	260	21-06936-05	261	21-06961-25	263	21-06991-04	266	21-07020-04	269
		21-06914-13	260	21-06936-07	261	21-06961-32	263	21-06991-05	266	21-07020-05	269
		21-06914-16	260	21-06936-10	261	21-06964-06	263	21-06991-06	266	21-07020-06	269
		21-06914-19	260	21-06936-15	261	21-06964-09	263	21-06991-10	266	21-07022-10	269
		21-06914-25	260	21-06936-20	261	21-06964-13	263	21-06991-20	266	21-07022-20	269
		21-06914-32	260	21-06936-25	261	21-06964-16	263	21-06991-30	266	21-07022-30	269
		21-06915-06	260	21-06936-30	261	21-06964-19	263	21-06993-01	266	21-07022-40	269
		21-06915-09	260	21-06938-05	261	21-06964-25	263	21-06993-02	266	21-07024-01	269
		21-06915-13	260	21-06938-07	261	21-06964-32	263	21-06993-03	266	21-07024-02	269

Cat #	Pg #	Cat #	Pg #	Cat #	Pg #	Cat #	Pg #	Cat #	Pg #	Cat #	Pg #
21-07024-10	269	21-07120-10	275	21-07262-12	283	21-07442-21	293	21-07607-18	301	21-07758-13	309
21-07024-20	269	21-07120-15	275	21-07262-19	283	21-07446-21	293	21-07610-17	301	21-07760-18	309
21-07028-01	270	21-07120-20	275	21-07262-25	283	21-07450-16	294	21-07611-17	301	21-07761-18	309
21-07028-02	270	21-07120-25	275	21-07266-15	283	21-07450-24	294	21-07615-15	301	21-07762-13	309
21-07028-03	270	21-07124-17	275	21-07268-15	283	21-07454-17	294	21-07617-15	301	21-07764-17	309
21-07030-01	270	21-07126-19	275	21-07272-21	283	21-07454-21	294	21-07619-15	301	21-07766-17	309
21-07030-10	270	21-07130-20	275	21-07276-19	283	21-07456-17	294	21-07621-15	301	21-07768-23	310
21-07030-20	270	21-07134-16	275	21-07280-19	283	21-07456-21	294	21-07623-18	302	21-07770-31	310
21-07030-30	270	21-07138-19	275	21-07284-17	283	21-07460-18	294	21-07626-17	302	21-07772-27	310
21-07031-01	270	21-07142-29	275	21-07288-14	284	21-07460-23	294	21-07627-17	302	21-07772-30	310
21-07031-10	270	21-07146-13	275	21-07288-15	284	21-07460-25	294	21-07630-18	302	21-07774-12	310
21-07031-20	270	21-07150-15	276	21-07290-15	284	21-07460-28	294	21-07631-18	302	21-07774-15	310
21-07031-30	270	21-07154-16	276	21-07292-15	284	21-07461-23	294	21-07635-15	302	21-07774-35	310
21-07034-03	270	21-07158-01	276	21-07296-12	284	21-07461-25	294	21-07637-15	302	21-07776-39	310
21-07034-04	270	21-07158-02	276	21-07300-06	284	21-07461-28	294	21-07639-15	302	21-07776-43	310
21-07034-05	270	21-07158-03	276	21-07302-08	284	21-07464-21	294	21-07642-20	302	21-07776-45	310
21-07038-13	271	21-07158-04	276	21-07304-26	285	21-07464-27	294	21-07645-15	303	21-07776-47	310
21-07038-14	271	21-07162-06	276	21-07305-26	285	21-07464-30	294	21-07647-15	303	21-07778-00	311
21-07038-17	271	21-07162-08	276	21-07306-17	285	21-07468-19	295	21-07650-15	303	21-07778-01	311
21-07038-20	271	21-07166-29	277	21-07308-17	285	21-07470-19	295	21-07651-15	303	21-07778-02	311
21-07040-13	271	21-07168-29	277	21-07308-22	285	21-07474-17	295	21-07653-18	303	21-07778-03	311
21-07040-16	271	21-07170-28	277	21-07308-24	285	21-07478-25	295	21-07655-18	303	21-07778-04	311
21-07040-20	271	21-07174-01	277	21-07308-26	286	21-07478-26	295	21-07659-18	303	21-07778-05	311
21-07044-00	271	21-07174-02	277	21-07308-28	286	21-07478-27	295	21-07663-18	303	21-07778-06	311
21-07044-01	271	21-07174-03	277	21-07310-24	286	21-07482-15	296	21-07666-18	303	21-07778-10	311
21-07044-02	271	21-07178-22	277	21-07312-24	286	21-07482-19	296	21-07666-23	303	21-07780-15	312
21-07050-15	271	21-07182-01	278	21-07314-24	286	21-07482-24	296	21-07667-18	303	21-07784-14	312
21-07054-00	271	21-07182-02	278	21-07316-22	286	21-07482-26	296	21-07667-23	303	21-07786-21	312
21-07054-01	271	21-07182-03	278	21-07316-26	287	21-07482-28	296	21-07671-20	304	21-07788-14	312
21-07054-02	271	21-07182-04	278	21-07316-29	287	21-07486-30	296	21-07675-24	304	21-07792-14	313
21-07058-13	271	21-07182-05	278	21-07318-27	287	21-07490-22	296	21-07679-03	304	21-07794-16	313
21-07058-15	271	21-07182-06	278	21-07318-34	287	21-07490-27	296	21-07679-04	304	21-07798-01	313
21-07058-16	271	21-07182-07	278	21-07320-29	287	21-07490-30	296	21-07679-05	304	21-07798-02	313
21-07062-15	271	21-07186-01	278	21-07322-24	288	21-07494-23	296	21-07681-03	304	21-07798-03	313
21-07064-18	271	21-07186-02	278	21-07324-25	288	21-07494-26	296	21-07681-04	304	21-07798-04	313
21-07069-01	272	21-07188-01	278	21-07324-21	288	21-07498-22	296	21-07681-05	304	21-07798-05	313
21-07069-02	272	21-07188-02	278	21-07328-25	288	21-07498-25	296	21-07684-22	305	21-07802-18	313
21-07069-03	272	21-07190-01	278	21-07332-23	288	21-07498-33	296	21-07685-22	305	21-07802-20	313
21-07069-04	272	21-07190-02	278	21-07336-32	289	21-07502-26	297	21-07688-27	305	21-07806-16	313
21-07069-05	272	21-07194-04	279	21-07340-13	289	21-07506-19	297	21-07689-27	305	21-07806-20	313
21-07069-06	272	21-07194-06	279	21-07340-19	289	21-07506-23	297	21-07693-23	305	21-07810-16	313
21-07069-10	272	21-07194-08	279	21-07340-23	289	21-07506-26	297	21-07697-23	306	21-07814-13	314
21-07069-20	272	21-07194-10	279	21-07340-30	289	21-07510-33	297	21-07701-02	306	21-07814-18	314
21-07069-30	272	21-07194-13	279	21-07344-26	289	21-07510-45	297	21-07701-03	306	21-07818-17	314
21-07072-01	272	21-07194-19	279	21-07346-26	289	21-07514-33	297	21-07701-04	306	21-07822-15	314
21-07072-02	272	21-07194-25	279	21-07350-44	289	21-07514-45	297	21-07705-03	306	21-07826-17	314
21-07072-03	272	21-07198-01	280	21-07350-64	289	21-07518-14	297	21-07705-04	306	21-07828-17	314
21-07072-04	272	21-07199-02	280	21-07354-01	290	21-07522-12	297	21-07705-05	306	21-07830-19	314
21-07072-05	272	21-07201-03	280	21-07354-02	290	21-07526-13	298	21-07705-08	306	21-07834-15	315
21-07072-06	272	21-07203-04	280	21-07354-03	290	21-07530-20	298	21-07709-23	306	21-07836-18	315
21-07072-10	272	21-07206-05	280	21-07356-04	290	21-07534-17	298	21-07713-23	306	21-07837-16	315
21-07072-20	272	21-07207-14	280	21-07358-05	290	21-07538-17	298	21-07716-30	306	21-07840-12	316
21-07072-30	272	21-07209-14	280	21-07362-01	290	21-07542-19	298	21-07718-30	306	21-07844-15	316
21-07074-01	272	21-07211-20	280	21-07362-02	290	21-07546-18	298	21-07721-20	307	21-07848-18	316
21-07074-02	272	21-07214-20	281	21-07366-21	290	21-07546-20	298	21-07724-14	307	21-07852-18	316
21-07074-03	272	21-07218-08	281	21-07370-17	290	21-07546-22	298	21-07724-19	307	21-07856-18	316
21-07074-04	272	21-07218-17	281	21-07374-17	291	21-07550-12	298	21-07724-22	307	21-07860-22	316
21-07074-05	272	21-07222-10	281	21-07376-17	291	21-07554-18	298	21-07725-14	307	21-07864-22	316
21-07074-06	272	21-07222-13	281	21-07378-17	291	21-07554-50	298	21-07725-17	307	21-07868-16	317
21-07074-10	272	21-07222-19	281	21-07382-22	291	21-07557-17	299	21-07725-19	307	21-07868-21	317
21-07074-20	272	21-07222-25	281	21-07384-22	291	21-07559-17	299	21-07725-19	307	21-07872-01	317
21-07074-30	272	21-07224-10	281	21-07388-17	291	21-07563-17	299	21-07725-22	307	21-07872-02	317
21-07078-30	273	21-07224-13	281	21-07392-21	291	21-07567-12	299	21-07728-15	307	21-07872-03	317
21-07080-27	273	21-07224-19	281	21-07396-01	291	21-07571-14	299	21-07731-15	307	21-07872-04	317
21-07084-25	273	21-07228-07	282	21-07396-02	291	21-07575-15	300	21-07731-17	307	21-07872-05	317
21-07088-24	273	21-07228-15	282	21-07402-20	291	21-07577-15	300	21-07734-15	307	21-07876-18	317
21-07092-22	273	21-07228-20	282	21-07406-20	292	21-07580-20	300	21-07735-15	307	21-07876-27	317
21-07096-15	274	21-07232-18	282	21-07407-20	292	21-07583-14	300	21-07739-17	307	21-07876-27	317
21-07098-15	274	21-07236-20	282	21-07410-23	292	21-07583-17	300	21-07742-18	308	21-07880-01	317
21-07100-15	274	21-07238-20	282	21-07414-19	292	21-07587-18	300	21-07746-18	308	21-07880-02	317
21-07102-15	274	21-07240-23	282	21-07416-19	292	21-07587-18	300	21-07747-18	308	21-07880-03	317
21-07104-19	274	21-07244-15	282	21-07420-21	292	21-07591-20	300	21-07749-21	308	21-07884-10	318
21-07108-18	274	21-07248-17	282	21-07424-19	293	21-07595-16	301	21-07750-23	308	21-07884-12	318
21-07110-21	274	21-07250-16	282	21-07428-18	293	21-07597-16	301	21-07750-27	308	21-07884-20	318
21-07114-19	274	21-07254-20	282	21-07432-20	293	21-07601-19	301	21-07751-23	308	21-07884-30	318
21-07116-18	274	21-07258-16	283	21-07434-20	293	21-07603-16	301	21-07751-27	308	21-07884-40	318
21-07120-05	275	21-07262-06	283	21-07438-17	293	21-07603-16	301	21-07753-27	308	21-07884-42	318
						21-07603-19	301	21-07755-24	308	21-07884-51	318

21

Cat #	Pg #	Cat #	Pg #	Cat #	Pg #	Cat #	Pg #	Cat #	Pg #	Cat #	Pg #
21-07888-00	319	22-08028-11	326	25-08148-24	331	25-08279-30	343	25-08400-01	351	26-08508-03	359
21-07892-01	319	22-08028-12	326	25-08152-16	331	25-08282-22	344	25-08400-21	351	26-08510-21	360
21-07892-02	319	22-08028-13	326	25-08156-16	331	25-08286-20	344	25-08404-00	351	26-08512-21	360
21-07892-03	319	22-08030-08	326	25-08156-20	331	25-08290-15	344	25-08404-01	351	26-08514-21	360
21-07896-10	320	22-08030-09	326	25-08160-18	332	25-08291-15	344	25-08408-00	351	26-08514-22	360
21-07896-35	320	22-08030-10	326	25-08160-20	332	25-08294-06	344	25-08408-01	351	26-08516-23	360
21-07896-50	320	22-08030-11	326	25-08160-23	332	25-08294-08	344	25-08412-19	351	26-08518-23	360
21-07896-70	320	22-08030-12	326	25-08164-18	332	25-08294-12	344	25-08414-00	351	26-08520-23	360
21-07900-18	320	22-08030-13	326	25-08164-20	332	25-08294-15	344			26-08522-24	361
21-07904-24	320			25-08168-20	332	25-08298-19	344			26-08524-00	361
21-07908-19	320			25-08168-23	332	25-08302-17	345			26-08528-00	361
21-07912-23	320			25-08172-20	332	25-08306-15	345			26-08536-00	362
21-07916-21	320			25-08176-24	332	25-08310-01	345	26-08416-20	352	26-08540-00	362
21-07920-19	321			25-08180-24	332	25-08310-02	345	26-08416-22	352	26-08544-27	362
21-07924-19	321			25-08182-26	332	25-08310-03	345	26-08416-24	352	26-08548-26	362
21-07924-25	321			25-08186-18	333	25-08210-04	345	26-08418-23	352	26-08552-08	363
21-07928-16	321			25-08187-18	333	25-08314-01	345	26-08418-24	352	26-08552-10	363
21-07932-17	321			25-08190-21	333	25-08314-02	345	26-08420-23	352	26-08552-12	363
21-07936-14	321			25-08190-23	333	25-08318-22	346	26-08424-23	353	26-08552-14	363
21-07940-18	321			25-08191-21	333	25-08322-01	346	26-08428-23	353	26-08552-16	363
21-07944-19	321			25-08191-23	333	25-08322-02	346	26-08432-23	353	26-08552-18	363
21-07948-34	322			25-08194-25	333	25-08322-03	346	26-08436-20	354	26-08552-20	363
21-07950-18	322			25-08198-13	334	25-08322-04	346	26-08438-20	354	26-08552-22	363
21-07950-23	322			25-08198-16	334	25-08326-01	346	26-08442-01	354	26-08552-22	363
21-07952-40	322			25-08198-18	334	25-08326-02	346	26-08442-02	354	26-08552-24	363
21-07952-45	322			25-08198-18	334	25-08330-00	347	26-08446-01	354	26-08552-26	363
21-07952-55	322			25-08198-23	334	25-08330-01	347	26-08446-02	354	26-08552-28	363
21-07956-31	322			25-08199-13	334	25-08330-02	347	26-08446-03	354	26-08552-30	363
21-07960-50	322			25-08199-16	334	25-08330-03	347	26-08446-04	354	26-08552-32	363
21-07962-30	322			25-08199-18	334	25-08330-04	347	26-08450-01	355	26-08552-34	363
21-07964-50	322			25-08199-19	334	25-08334-00	347	26-08450-02	355	26-08552-36	363
21-07968-16	323			25-08199-21	334	25-08334-01	347	26-08454-01	355	26-08552-50	363
21-07972-02	323			25-08199-23	334	25-08334-02	347	26-08454-02	355	26-08552-60	363
21-07972-03	323			25-08202-21	335	25-08338-28	348	26-08458-21	355	26-08554-08	363
21-07972-04	323			25-08203-21	335	25-08338-35	348	26-08462-21	355	26-08554-09	363
21-07972-05	323			25-08206-23	335	25-08338-42	348	26-08466-20	356	26-08554-10	363
21-07976-20	323			25-08207-23	335	25-08340-28	348	26-08467-20	356	26-08554-11	363
21-07980-15	323			25-08210-25	335	25-08340-35	348	26-08472-20	356	26-08554-12	363
21-07980-19	323			25-08211-25	335	25-08340-42	348	26-08473-20	356	26-08554-13	363
21-07980-24	323			25-08215-25	335	25-08342-28	348	26-08476-24	356	26-08554-14	363
21-07981-15	323			25-08219-30	336	25-08342-35	348	26-08480-01	356	26-08554-15	363
21-07981-19	323			25-08223-26	336	25-08342-42	348	26-08480-02	356	26-08554-16	363
21-07981-24	323			25-08223-28	336	25-08344-28	348	26-08484-01	357	26-08554-17	363
21-07984-20	324			25-08227-24	336	25-08344-35	348	26-08484-02	357	26-08554-18	363
21-07985-20	324			25-08231-24	336	25-08344-42	348	26-08484-03	357	26-08554-19	363
21-07988-13	324			25-08233-24	336	25-08348-00	348	26-08488-01	357	26-08554-20	363
21-07992-11	324			25-08236-13	337	25-08348-33	348	26-08488-02	357	26-08554-21	363
21-07996-15	324			25-08237-13	337	25-08348-40	348	26-08488-03	357	26-08554-22	363
21-07997-15	324			25-08240-22	337	25-08350-33	348	26-08488-04	357	26-08554-23	363
				25-08240-25	337	25-08350-40	348	26-08488-05	357	26-08554-24	363
				25-08240-28	337	25-08352-33	348	26-08488-06	357	26-08554-25	363
				25-08241-22	337	25-08352-40	348	26-08488-07	357	26-08554-26	363
				25-08241-25	337	25-08353-33	348	26-08488-08	357	26-08554-27	363
				25-08241-28	337	25-08354-40	348	26-08488-09	357	26-08554-28	363
				25-08244-22	338	25-08358-33	348	26-08488-10	357	26-08554-29	363
				25-08244-25	338	25-08358-40	348	26-08488-11	357	26-08554-30	363
				25-08244-28	338	25-08360-33	348	26-08488-12	357	26-08556-08	363
				25-08245-22	338	25-08360-40	348	26-08488-13	357	26-08556-09	363
				25-08245-25	338	25-08362-33	348	26-08492-01	358	26-08556-10	363
				25-08245-28	338	25-08362-40	348	26-08492-02	358	26-08556-11	363
				25-08248-25	339	25-08364-30	348	26-08492-03	358	26-08556-12	363
				25-08249-25	339	25-08364-40	348	26-08492-04	358	26-08556-13	363
				25-08252-15	339	25-08366-21	349	26-08496-02	358	26-08556-14	363
				25-08253-15	339	25-08368-21	349	26-08496-03	358	26-08556-15	363
				25-08253-20	339	25-08372-30	349	26-08496-04	358	26-08556-16	363
				25-08255-12	339	25-08376-40	349	26-08496-05	358	26-08556-17	363
				25-08258-15	340	25-08380-01	349	26-08496-06	358	26-08556-18	363
				25-08258-21	340	25-08380-02	349	26-08496-08	358	26-08556-19	363
				25-08258-35	340	25-08384-11	350	26-08496-11	358	26-08556-20	363
				25-08262-30	341	25-08384-16	350	26-08496-15	358	26-08556-21	363
				25-08263-30	341	25-08388-10	350	26-08500-28	359	26-08556-22	363
				25-08266-33	342	25-08388-50	350	26-08504-01	359	26-08556-23	363
				25-08267-33	342	25-08392-10	350	26-08504-02	359	26-08556-24	363
				25-08270-33	342	25-08392-12	350	26-08504-03	359	26-08556-25	363
				25-08271-33	342	25-08396-00	350	26-08506-28	359	26-08556-26	363
				25-08274-36	343	25-08396-50	350	26-08508-01	359	26-08556-27	363
				25-08278-30	343	25-08400-00	351	26-08508-02	359	26-08556-28	363

23

24

25

26

22

22-08000-13	325	25-08096-15	330	25-08100-15	330	25-08241-25	337	25-08352-33	348	26-08488-06	357	26-08554-25	363
22-08000-15	325	25-08100-15	330	25-08100-19	330	25-08241-28	337	25-08352-40	348	26-08488-07	357	26-08554-26	363
22-08004-14	325	25-08100-19	330	25-08100-23	330	25-08241-28	337	25-08353-33	348	26-08488-08	357	26-08554-27	363
22-08006-13	325	25-08100-23	330	25-08100-25	330	25-08244-22	338	25-08354-40	348	26-08488-09	357	26-08554-28	363
22-08010-07	325	25-08100-25	330	25-08104-12	330	25-08244-25	338	25-08358-33	348	26-08488-10	357	26-08554-29	363
22-08013-16	325	25-08104-12	330	25-08104-14	330	25-08244-28	338	25-08358-40	348	26-08488-11	357	26-08554-30	363
22-08015-16	325	25-08104-14	330	25-08108-16	330	25-08245-22	338	25-08360-33	348	26-08488-12	357	26-08556-08	363
22-08018-21	325	25-08108-16	330	25-08108-16	330	25-08245-25	338	25-08360-40	348	26-08488-13	357	26-08556-09	363
22-08022-08	325	25-08108-20	330	25-08108-20	330	25-08245-28	338	25-08362-33	348	26-08492-01	358	26-08556-10	363
22-08022-10	325	25-08108-25	330	25-08108-25	330	25-08248-25	339	25-08362-40	348	26-08492-02	358	26-08556-11	

Cat #	Pg #	Cat #	Pg #	Cat #	Pg #	Cat #	Pg #	Cat #	Pg #	Cat #	Pg #
26-08556-29	363	27-08624-02	367	27-08718-18	373	27-08794-01	378	27-08816-23	380	27-08990-27	388
26-08556-30	363	27-08624-03	367	27-08722-18	374	27-08794-02	378	27-08816-27	380	27-08994-27	389
26-08560-06	364	27-08624-04	367	27-08726-19	374	27-08794-03	378	27-08816-31	380	27-08998-23	389
26-08560-07	364	27-08628-01	368	27-08730-19	374	27-08798-01	379	27-08816-35	380	27-09002-25	389
26-08560-08	364	27-08628-02	368	27-08734-00	374	27-08798-02	379	27-08816-39	380	27-09006-18	389
26-08560-09	364	27-08628-03	368	27-08734-01	374	27-08798-03	379	27-08816-43	380	27-09006-20	389
26-08560-10	364	27-08632-00	368	27-08734-02	374	27-08798-04	379	27-08820-34	381	27-09010-23	390
26-08560-11	364	27-08636-01	368	27-08736-00	374	27-08798-05	379	27-08822-28	381	27-09014-22	390
26-08560-12	364	27-08636-02	368	27-08736-01	374	27-08798-06	379	27-08824-28	381	27-09016-22	390
26-08560-13	364	27-08640-00	368	27-08736-02	374	27-08798-07	379	27-08826-28	381	27-09020-01	390
26-08560-14	364	27-08644-01	369	27-08740-00	375	27-08798-08	379	27-08830-24	381	27-09020-02	390
26-08560-15	364	27-08644-02	369	27-08740-01	375	27-08798-09	379	27-08832-24	381	27-09020-03	390
26-08560-16	364	27-08644-03	369	27-08740-02	375	27-08798-10	379	27-08836-28	381	27-09020-04	390
26-08560-17	364	27-08648-01	369	27-08742-00	375	27-08798-11	379	27-08838-28	381	27-09020-05	390
26-08560-18	364	27-08648-02	369	27-08742-01	375	27-08798-12	379	27-08832-32	382	27-09024-17	390
26-08560-19	364	27-08648-03	369	27-08742-02	375	27-08798-13	379	27-08844-32	382	27-09026-17	390
26-08560-20	364	27-08652-01	369	27-08746-01	375	27-08798-14	379	27-08846-32	382	27-09030-27	390
26-08560-21	364	27-08652-02	369	27-08746-02	375	27-08798-15	379	27-08850-32	382	27-09034-27	391
26-08560-22	364	27-08656-01	369	27-08746-03	375	27-08798-16	379	27-08852-32	382	27-09038-04	391
26-08560-23	364	27-08656-02	369	27-08750-01	376	27-08798-17	379	27-08854-32	382	27-09038-05	391
26-08560-24	364	27-08658-02	369	27-08750-02	376	27-08798-18	379	27-08858-25	382	27-09042-24	391
26-08562-06	364	27-08662-01	370	27-08750-03	376	27-08798-19	379	27-08862-28	382	27-09046-01	391
26-08562-07	364	27-08662-02	370	27-08752-01	376	27-08798-20	379	27-08866-28	383	27-09046-02	391
26-08562-08	364	27-08662-03	370	27-08752-02	376	27-08798-21	379	27-08870-01	383	27-09046-03	391
26-08562-09	364	27-08666-01	370	27-08752-03	376	27-08798-22	379	27-08870-02	383	27-09046-04	391
26-08562-10	364	27-08666-02	370	27-08752-04	376	27-08798-23	379	27-08870-03	383	27-09050-24	391
26-08562-11	364	27-08666-03	370	27-08752-05	376	27-08798-24	379	27-08872-01	383	27-09054-30	392
26-08562-12	364	27-08670-01	370	27-08754-01	376	27-08798-25	379	27-08874-01	383	27-09056-30	392
26-08562-13	364	27-08670-02	370	27-08754-02	376	27-08798-26	379	27-08874-02	383	27-09060-30	392
26-08562-14	364	27-08670-03	370	27-08754-03	376	27-08798-27	379	27-08874-03	383	27-09062-30	392
26-08562-15	364	27-08674-01	371	27-08754-04	376	27-08798-28	379	27-08876-01	384	27-09066-30	392
26-08562-16	364	27-08674-02	371	27-08754-05	376	27-08798-29	379	27-08878-01	384	27-09068-30	392
26-08562-17	364	27-08674-03	371	27-08758-01	376	27-08798-30	379	27-08878-02	384	27-09072-31	392
26-08562-18	364	27-08678-00	371	27-08758-02	376	27-08798-50	379	27-08878-01	384	27-09072-31	392
26-08562-19	364	27-08682-00	371	27-08758-03	376	27-08798-60	379	27-08880-01	384	27-09074-31	392
26-08562-20	364	27-08682-01	371	27-08758-02	376	27-08800-01	379	27-08880-02	384	27-09078-23	393
26-08562-21	364	27-08682-02	371	27-08760-01	376	27-08800-02	379	27-08880-03	384	27-09082-24	393
26-08562-22	364	27-08682-03	371	27-08760-02	376	27-08800-03	379	27-08882-01	384	27-09086-21	393
26-08562-23	364	27-08684-00	371	27-08760-03	376	27-08800-04	379	27-08882-02	384	27-09086-29	393
26-08562-24	364	27-08684-01	371	27-08762-01	376	27-08800-05	379	27-08886-27	385	27-09090-26	393
26-08562-24	364	27-08684-02	371	27-08762-02	376	27-08800-06	379	27-08890-17	385	27-09094-27	393
26-08566-39	364	27-08686-00	371	27-08762-03	376	27-08800-07	379	27-08894-18	385	27-09098-25	393
26-08568-35	364	27-08686-01	371	27-08766-01	376	27-08800-08	379	27-08898-25	385	27-09102-01	394
26-08572-08	365	27-08686-02	371	27-08766-02	376	27-08800-09	379	27-08902-25	385	27-09102-02	394
26-08572-11	365	27-08690-00	372	27-08766-03	376	27-08800-10	379	27-08906-25	385	27-09106-21	394
26-08571-13	365	27-08690-01	372	27-08770-01	377	27-08800-11	379	27-08910-25	385	27-09110-28	394
26-08572-16	365	27-08690-02	372	27-08770-02	377	27-08800-12	379	27-08914-28	385	27-09114-19	394
26-08572-21	365	27-08692-00	372	27-08772-01	377	27-08800-13	379	27-08918-24	386	27-09118-20	395
26-08572-26	365	27-08692-01	372	27-08772-02	377	27-08800-14	379	27-08922-26	386	27-09118-25	395
26-08572-32	365	27-08692-02	372	27-08776-01	377	27-08800-15	379	27-08926-20	386	27-09118-30	395
26-08576-00	365	27-08696-00	372	27-08776-02	377	27-08800-16	379	27-08926-20	386	27-09118-30	395
26-08580-00	365	27-08696-01	372	27-08780-20	377	27-08800-17	379	27-08930-26	386	27-09118-35	395
26-08584-20	365	27-08696-02	372	27-08780-25	377	27-08800-18	379	27-08934-20	386	27-09118-40	395
26-08588-26	365	27-08698-00	372	27-08780-30	377	27-08800-19	379	27-08934-24	386	27-09122-20	395
		27-08698-01	372	27-08780-35	377	27-08800-19	379	27-08936-20	386	27-09124-04	395
		27-08698-02	372	27-08780-40	377	27-08804-00	379	27-08936-24	386	27-09124-06	395
		27-08700-00	372	27-08782-20	377	27-08804-02	379	27-08938-20	386	27-09124-23	395
		27-08700-01	372	27-08782-25	377	27-08804-04	379	27-08938-24	386	27-09128-24	395
		27-08700-02	372	27-08782-30	377	27-08804-06	379	27-08942-06	387	27-09130-23	395
		27-08704-00	373	27-08782-35	377	27-08804-10	379	27-08942-08	387	27-09134-23	396
		27-08704-01	373	27-08782-40	377	27-08804-12	379	27-08942-10	387	27-09136-21	396
		27-08704-02	373	27-08784-20	377	27-08804-14	379	27-08944-08	387	27-09140-28	396
		27-08706-00	373	27-08784-25	377	27-08804-16	379	27-08944-08	387	27-09144-24	397
		27-08706-01	373	27-08784-30	377	27-08804-18	379	27-08944-10	387	27-09148-23	397
		27-08706-02	373	27-08784-35	377	27-08804-20	379	27-08948-06	387	27-09152-00	398
		27-08708-00	373	27-08784-40	377	27-08804-22	379	27-08948-08	387	27-09152-01	398
		27-08708-01	373	27-08786-20	377	27-08804-24	379	27-08948-10	387	27-09154-00	398
		27-08708-02	373	27-08786-25	377	27-08804-26	379	27-08952-06	387	27-09154-01	398
		27-08712-20	373	27-08786-30	377	27-08806-00	379	27-08952-10	387	27-09156-00	398
		27-08712-25	373	27-08786-35	377	27-08810-00	380	27-08952-08	387	27-09156-01	398
		27-08712-30	373	27-08786-40	377	27-08810-10	380	27-08956-16	387	27-09158-00	398
		27-08712-35	373	27-08790-00	378	27-08810-12	380	27-08960-28	387	27-09158-01	398
		27-08712-40	373	27-08790-01	378	27-08810-14	380	27-08964-24	388	27-09160-00	398
		27-08714-20	373	27-08790-02	378	27-08810-16	380	27-08968-26	388	27-09160-01	398
		27-08714-25	373	27-08790-03	378	27-08810-18	380	27-08972-21	388	27-09162-00	398
		27-08714-30	373	27-08790-04	378	27-08810-20	380	27-08974-21	388	27-09162-01	398
		27-08714-35	373	27-08790-05	378	27-08816-00	380	27-08978-32	388	27-09164-00	398
		27-08714-40	373	27-08794-00	378	27-08816-15	380	27-08982-20	388	27-09164-01	398
						27-08816-19	380	27-08986-25	388	27-09168-01	399

27-08592-01	366	27-08700-01	372	27-08782-25	377	27-08804-08	379	27-08942-06	387	27-09130-23	395
27-08592-02	366	27-08700-02	372	27-08782-30	377	27-08804-10	379	27-08942-08	387	27-09134-23	396
27-08592-03	366	27-08704-00	373	27-08782-35	377	27-08804-12	379	27-08942-10	387	27-09136-21	396
27-08596-01	366	27-08704-01	373	27-08782-40	377	27-08804-14	379	27-08944-08	387	27-09140-28	396
27-08596-02	366	27-08704-02	373	27							

27

Cat #	Pg #	Cat #	Pg #	Cat #	Pg #
27-09168-02	399	27-09222-01	402	27-09230-16	403
27-09168-03	399	27-09222-02	402	27-09230-19	403
27-09168-04	399	27-09222-03	402	27-09230-20	403
27-09168-05	399	27-09222-04	402	27-09230-21	403
27-09168-06	399	27-09222-05	402	27-09230-23	403
27-09170-01	399	27-09222-06	402	27-09230-25	403
27-09170-02	399	27-09223-01	402	27-09230-30	403
27-09170-03	399	27-09223-02	402	27-09230-35	403
27-09170-04	399	27-09223-03	402	27-09230-40	403
27-09170-05	399	27-09223-04	402	27-09231-05	403
27-09170-06	399	27-09223-05	402	27-09231-06	403
27-09174-01	399	27-09223-06	402	27-09231-07	403
27-09174-02	399	27-09226-05	403	27-09231-08	403
27-09174-03	399	27-09226-06	403	27-09231-09	403
27-09174-04	399	27-09226-07	403	27-09231-11	403
27-09174-05	399	27-09226-08	403	27-09231-12	403
27-09177-01	400	27-09226-09	403	27-09231-14	403
27-09177-02	400	27-09226-11	403	27-09231-15	403
27-09177-03	400	27-09226-12	403	27-09231-16	403
27-09177-04	400	27-09226-14	403	27-09231-19	403
27-09177-05	400	27-09226-15	403	27-09231-20	403
27-09177-06	400	27-09226-16	403	27-09231-21	403
27-09180-10	400	27-09226-19	403	27-09231-23	403
27-09180-12	400	27-09226-20	403	27-09231-25	403
27-09180-14	400	27-09226-21	403	27-09231-30	403
27-09184-30	400	27-09226-23	403	27-09231-35	403
27-09188-24	400	27-09227-05	403	27-09231-40	403
27-09192-24	400	27-09227-06	403	27-09232-05	403
27-09196-05	401	27-09227-07	403	27-09232-06	403
27-09196-07	401	27-09227-08	403	27-09232-07	403
27-09196-09	401	27-09227-09	403	27-09232-08	403
27-09198-05	401	27-09227-11	403	27-09232-09	403
27-09198-07	401	27-09227-12	403	27-09232-11	403
27-09198-09	401	27-09227-14	403	27-09232-12	403
27-09202-04	401	27-09227-15	403	27-09232-14	403
27-09202-06	401	27-09227-16	403	27-09232-15	403
27-09202-08	401	27-09227-19	403	27-09232-16	403
27-09202-10	401	27-09227-20	403	27-09232-17	403
27-09202-12	401	27-09227-21	403	27-09232-20	403
27-09202-14	401	27-09227-23	403	27-09232-21	403
27-09206-00	401	27-09228-05	403	27-09232-23	403
27-09210-01	402	27-09228-06	403	27-09232-25	403
27-09210-02	402	27-09228-07	403	27-09232-30	403
27-09210-03	402	27-09228-08	403	27-09232-35	403
27-09210-04	402	27-09228-09	403	27-09232-40	403
27-09210-05	402	27-09228-11	403	27-09233-05	403
27-09210-06	402	27-09228-12	403	27-09233-06	403
27-09211-01	402	27-09228-14	403	27-09233-07	403
27-09211-02	402	27-09228-15	403	27-09233-08	403
27-09211-03	402	27-09228-16	403	27-09233-09	403
27-09211-04	402	27-09228-19	403	27-09233-11	403
27-09211-05	402	27-09228-20	403	27-09233-12	403
27-09211-06	402	27-09228-21	403	27-09233-14	403
27-09214-01	402	27-09228-23	403	27-09233-15	403
27-09214-02	402	27-09229-05	403	27-09233-16	403
27-09214-03	402	27-09229-06	403	27-09233-19	403
27-09214-04	402	27-09229-07	403	27-09233-20	403
27-09214-05	402	27-09229-08	403	27-09233-21	403
27-09214-06	402	27-09229-09	403	27-09233-23	403
27-09215-01	402	27-09229-11	403	27-09233-25	403
27-09215-02	402	27-09229-12	403	27-09233-30	403
27-09215-03	402	27-09229-14	403	27-09233-35	403
27-09215-04	402	27-09229-15	403	27-09233-40	403
27-09215-05	402	27-09229-16	403	27-09236-16	404
27-09215-06	402	27-09229-19	403	27-09236-18	404
27-09218-01	402	27-09229-20	403	27-09236-19	404
27-09218-02	402	27-09229-21	403	27-09236-21	404
27-09218-03	402	27-09229-23	403	27-09236-23	404
27-09218-04	402	27-09230-05	403	27-09236-26	404
27-09218-05	402	27-09230-06	403	27-09236-28	404
27-09218-06	402	27-09230-07	403	27-09237-16	404
27-09219-01	402	27-09230-08	403	27-09237-18	404
27-09219-02	402	27-09230-09	403	27-09237-19	404
27-09219-03	402	27-09230-11	403	27-09237-21	404
27-09219-04	402	27-09230-12	403	27-09237-23	404
27-09219-05	402	27-09230-14	403	27-09237-26	404
27-09219-06	402	27-09230-15	403	27-09237-28	404

28

Cat #	Pg #	Cat #	Pg #	Cat #	Pg #
27-09240-27	404	29-09426-00	416	29-09546-23	424
27-09240-31	404	29-09426-01	416	29-09550-07	424
		29-09426-02	416	29-09550-08	424
		29-09426-03	416	29-09550-10	424
		29-09426-04	416	29-09550-12	424
		29-09426-05	416	29-09551-07	424
		29-09430-00	416	29-09551-08	424
		29-09430-01	416	29-09551-10	424
		29-09430-02	416	29-09551-12	424
		29-09430-03	416	29-09554-03	424
		29-09434-01	417	29-09555-03	424
		29-09434-02	417	29-09558-04	424
		29-09436-00	417	29-09559-04	424
		29-09438-01	418	29-09562-05	424
		29-09438-02	418	29-09563-05	424
		29-09438-03	418	29-09566-06	425
		29-09442-01	418	29-09566-07	425
		29-09442-02	418	29-09566-09	425
		29-09442-03	418	29-09566-11	425
		29-09446-01	418	29-09567-06	425
		29-09446-02	418	29-09567-07	425
		29-09450-01	419	29-09567-09	425
		29-09450-02	419	29-09567-11	425
		29-09450-03	419	29-09671-06	425
		29-09454-00	419	29-09575-07	425
		29-09454-01	419	29-09579-09	426
		29-09454-02	419	29-09583-10	426
		29-09454-03	419	29-09587-07	426
		29-09258-18	420	29-09591-09	426
		29-09462-19	420	29-09593-11	426
		29-09466-14	420	29-09596-21	427
		29-09470-16	420	29-09596-22	427
		29-09474-16	420	29-09599-21	427
		29-09478-25	420	29-09599-22	427
		29-09478-30	420	29-09601-21	427
		29-09482-30	420	29-09601-22	427
		29-09486-22	421	29-09605-21	428
		29-09490-24	421	29-09605-22	428
		29-09492-24	421	29-09609-20	428
		29-09496-20	421	29-09609-24	428
		29-09500-20	421	29-09613-20	428
		29-09504-01	421	29-09615-18	428
		29-09504-02	421	29-09618-01	429
		29-09508-01	421	29-09618-02	429
		29-09508-02	421	29-09618-03	429
		29-09512-15	422	29-09621-18	429
		29-09516-01	422	29-09624-15	429
		29-09516-02	422	29-09624-18	429
		29-09516-03	422	29-09625-15	429
		29-09516-04	422	29-09625-18	429
		29-09520-15	422	29-09629-20	429
		29-09520-19	422	29-09633-24	430
		29-09520-24	422	29-09633-27	430
		29-09524-18	423	29-09633-31	430
		29-09524-21	423	29-09633-33	430
		29-09526-18	423	29-09637-28	431
		29-09526-21	423	29-09641-30	431
		29-09530-15	423	29-09645-23	432
		29-09530-19	423	29-09649-21	432
		29-09530-24	423	29-09653-01	433
		29-09534-16	423	29-09653-02	433
		29-09534-20	423	29-09653-03	433
		29-09534-24	423	29-09653-04	433
		29-09534-30	423	29-09657-23	434
		29-09536-16	423	29-09657-25	434
		29-09536-20	423	29-09661-25	434
		29-09536-24	423	29-09665-27	435
		29-09536-30	423	29-09669-24	435
		29-09540-10	423	29-09673-24	435
		29-09540-20	423	29-09677-25	436
		29-09540-24	423	29-09677-26	436
		29-09540-30	423	29-09681-01	436
		29-09543-16	423	29-09681-02	436
		29-09543-20	423	29-09685-00	437
		29-09543-24	423	29-09685-20	437
		29-09543-30	423	29-09685-25	437
				29-09685-26	437

29

Cat #	Pg #	Cat #	Pg #	Cat #	Pg #	Cat #	Pg #	Cat #	Pg #	Cat #	Pg #
29-09685-27	437	29-09783-13	447	29-09855-00	457	30-09976-12	463	30-10039-11	468	30-10212-02	472
29-09685-28	437	29-09787-18	448	29-09857-05	458	30-09976-14	463	30-10041-12	468	30-10216-02	472
29-09689-01	437	29-09787-19	448	29-09857-10	458	30-09976-16	463	30-10043-13	468	30-10216-03	472
29-09689-02	437	29-09789-24	448	29-09857-15	458	30-09976-18	463	30-10045-13	468	30-10216-04	472
29-09693-21	438	29-09789-26	448	29-09857-20	458	30-09980-11	463	30-10047-13	468	30-10219-14	473
29-09695-21	438	29-09789-28	448	29-09857-25	458	30-09981-01	464	30-10049-01	468	30-10220-14	473
29-09699-17	438	29-09789-30	448	29-09857-30	458	30-09981-02	464	30-10049-02	468	30-10223-14	473
29-09703-17	438	29-09789-32	448	29-09857-35	458	30-09981-03	464	30-10049-03	468	30-10224-14	473
29-09707-16	439	29-09789-36	448	29-09857-40	458	30-09981-04	464	30-10049-04	468	30-10228-12	473
29-09711-01	439	29-09791-17	449	29-09857-45	458	30-09981-05	464	30-10051-12	468	30-10232-01	473
29-09711-02	439	29-09793-17	449	29-09857-50	458	30-09981-06	464	30-10053-13	468	30-10232-02	473
29-09714-00	440	29-09795-17	449	29-09857-70	458	30-09983-01	464	30-10055-12	468	30-10232-03	473
29-09715-15	440	29-09797-17	449	29-09857-90	458	30-09983-02	464	30-10057-01	468	30-10236-13	473
29-09715-30	440	29-09799-20	450	29-09858-05	458	30-09983-03	464	30-10057-02	468	30-10244-14	473
29-09715-45	440	29-09801-01	450	29-09858-10	458	30-09983-04	464	30-10057-03	468	30-10244-12	473
29-09715-90	440	29-09801-02	450	29-09858-15	458	30-09983-05	464	30-10059-12	468	30-10248-01	473
29-09718-00	440	29-09801-03	450	29-09858-20	458	30-09983-06	464	30-10061-12	469	30-10248-02	473
29-09718-15	440	29-09803-17	450	29-09858-25	458	30-09985-00	464	30-10063-12	469	30-10248-03	473
29-09718-30	440	29-09807-01	451	29-09858-30	458	30-09985-01	464	30-10065-12	469	30-10251-13	473
29-09718-45	440	29-09807-02	451	29-09858-35	458	30-09985-02	464	30-10067-12	469	30-10252-13	473
29-09718-90	440	29-09807-03	451	29-09858-40	458	30-09985-03	464	30-10069-12	469	30-10255-13	473
29-09723-20	441	29-09807-04	451	29-09858-45	458	30-09985-04	464	30-10071-12	469	30-10257-13	473
29-09723-22	441	29-09811-16	451	29-09858-50	458	30-09985-05	464	30-10073-12	469	30-10262-13	473
29-09723-24	441	29-09815-17	451	29-09858-70	458	30-09987-01	464	30-10075-12	469	30-10266-14	473
29-09723-30	441	29-09819-16	452	29-09858-90	458	30-09987-02	464	30-10077-12	469	30-10270-06	474
29-09727-18	441	29-09819-17	452	29-09860-05	458	30-09987-03	464	30-10079-12	469	30-10270-10	474
29-09727-19	441	29-09817-18	452	29-09860-10	458	30-09987-04	464	30-10081-12	469	30-10270-12	474
29-09727-23	441	29-09823-16	452	29-09860-15	458	30-09991-13	464	30-10083-12	469	30-10274-14	474
29-09727-27	441	29-09823-17	452	29-09860-20	458	30-09993-12	464	30-10085-12	469	30-10278-14	474
29-09731-18	442	29-09826-14	453	29-09860-25	458	30-09997-02	465	30-10087-13	469	30-10282-14	474
29-09731-20	442	29-09827-14	453	29-09860-30	458	30-09997-03	465	30-10089-13	469	30-10286-13	474
29-09731-23	442	29-09830-14	453	29-09860-35	458	30-09997-04	465	30-10091-13	469	30-10290-10	474
29-09731-25	442	29-09833-14	453	29-09860-40	458	30-09999-01	465	30-10093-12	469	30-10292-15	474
29-09735-24	442	29-09837-14	453	29-09860-50	458	30-09999-02	465	30-10095-12	469	30-10296-08	474
29-09739-24	443	29-09841-01	454			30-09999-03	465	30-10097-12	470	30-10296-10	474
29-09739-25	443	29-09841-02	454	30		30-09999-04	465	30-10099-13	470	30-10296-12	474
29-09739-26	443	29-09841-03	454	30-09862-07	459	30-10001-01	465	30-10099-13	470	30-10296-14	474
29-09742-21	443	29-09841-04	454	30-09862-09	459	30-10001-02	465	30-10101-13	470	30-10296-16	474
29-09742-23	443	29-09841-05	454	30-09862-09	459	30-10001-03	465	30-10105-12	470	30-10296-18	474
29-09742-27	443	29-09841-06	454	30-09864-07	459	30-10001-04	465	30-10107-12	470	30-10298-08	474
29-09742-31	443	29-09841-07	454	30-09864-09	459	30-10003-01	465	30-10109-12	470	30-10298-10	474
29-09743-21	443	29-09841-08	454	30-09868-08	459	30-10003-02	465	30-10111-12	470	30-10298-12	474
29-09743-23	443	29-09841-09	454	30-09870-08	459	30-10003-03	465	30-10113-12	470	30-10298-14	474
29-09743-27	443	29-09843-01	454	30-09872-08	459	30-10003-04	465	30-10115-13	470	30-10298-16	474
29-09743-31	443	29-09843-02	454	30-09874-03	459	30-10005-01	465	30-10117-12	470	30-10298-18	474
29-09746-12	444	29-09843-03	454	30-09874-04	459	30-10005-02	465	30-10119-13	470	30-10302-09	475
29-09747-12	444	29-09843-04	454	30-09876-04	459	30-10005-03	465	30-10121-13	470	30-10304-09	475
29-09750-14	444	29-09843-05	454	30-09878-07	459	30-10005-04	465	30-10123-13	470	30-10308-13	475
29-09750-16	444	29-09843-06	454	30-09880-03	460	30-10007-01	466	30-10125-13	470	30-10312-14	475
29-09750-18	444	29-09843-07	454	30-09884-03	460	30-10007-02	466	30-10127-13	470	30-10314-14	475
29-09750-20	444	29-09843-08	454	30-09888-06	460	30-10007-03	466	30-10129-14	471	30-10318-13	475
29-09751-14	444	29-09843-09	454	30-09892-07	460	30-10007-04	466	30-10132-10	471	30-10318-14	475
29-09751-16	444	29-09845-01	454	30-09894-07	460	30-10009-13	466	30-10133-12	471	30-10322-13	475
29-09751-18	444	29-09845-02	454	30-09898-07	460	30-10011-13	466	30-10136-12	471	30-10326-13	475
29-09751-20	444	29-09845-03	454	30-09900-07	460	30-10013-13	466	30-10140-01	471	30-10328-13	475
29-09754-16	445	29-09845-04	454	30-09904-05	460	30-10015-13	466	30-10140-02	471	30-10332-13	475
29-09755-16	445	29-09845-05	454	30-09904-07	460	30-10019-01	466	30-10144-12	471	30-10336-01	475
29-09755-14	445	29-09845-06	454	30-09908-05	461	30-10019-02	466	30-10147-13	471	30-10336-02	475
29-09759-14	445	29-09845-07	454	30-09908-07	461	30-10019-03	466	30-10148-13	471	30-10340-01	475
29-09759-15	445	29-09845-08	454	30-09912-08	461	30-10023-12	467	30-10152-13	471	30-10340-02	475
29-09759-16	445	29-09845-09	454	30-09916-06	461	30-10025-13	467	30-10156-13	471	30-10344-12	475
29-09762-17	445	29-09847-01	455	30-09916-09	461	30-10027-01	467	30-10160-13	471	30-10348-16	476
29-09763-17	445	29-09847-02	455	30-09920-04	461	30-10027-02	467	30-10164-13	471	30-10348-20	476
29-09765-17	445	29-09847-03	455	30-09920-05	461	30-10027-03	467	30-10168-01	471	30-10352-05	476
29-09767-17	445	29-09847-04	455	30-09924-08	461	30-10029-04	467	30-10168-02	471	30-10352-10	476
29-09771-16	446	29-09847-05	455	30-09928-07	461	30-10029-05	467	30-10172-01	471	30-10352-15	476
29-09771-17	446	29-09847-06	455	30-09928-08	461	30-10029-06	467	30-10172-02	471	30-10352-18	476
29-09775-01	446	29-09847-07	455	30-09932-08	462	30-10029-07	467	30-10176-12	471	30-10352-25	476
29-09775-02	446	29-09849-01	456	30-09936-08	462	30-10029-08	467	30-10180-12	471	30-10352-35	476
29-09775-03	446	29-09849-02	456	30-09940-05	462	30-10031-01	467	30-10184-13	471	30-10352-40	476
29-09779-14	446	29-09849-03	456	30-09944-07	462	30-10031-02	467	30-10188-12	472	30-10352-45	476
29-09779-16	446	29-09849-04	456	30-09948-06	462	30-10033-01	467	30-10190-13	472	30-10356-10	476
29-09779-18	446	29-09849-05	456	30-09952-08	462	30-10033-02	467	30-10194-12	472	30-10356-20	476
29-09782-12	447	29-09851-32	456	30-09956-07	462	30-10033-03	467	30-10198-13	472	30-10356-25	476
29-09783-10	447	29-09851-64	456	30-09960-04	462	30-10035-05	467	30-10201-12	472	30-10356-30	476
29-09783-11	447	29-09853-00	457	30-09964-13	463	30-10035-06	467	30-10204-12	472	30-10356-35	476
29-09783-12	447	29-09854-00	457	30-09968-13	463	30-10035-07	467	30-10208-12	472	30-10360-01	477
				30-09972-13	463	30-10037-13	468	30-10212-01	472		

30

Cat #	Pg #	Cat #	Pg #	Cat #	Pg #
30-10360-02	477	30-10452-67	484	30-10552-10	488
30-10360-03	477	30-10452-78	484	30-10556-10	488
30-10360-04	477	30-10454-00	484	30-10560-07	488
30-10360-05	477	30-10454-01	484	30-10564-09	489
30-10364-13	477	30-10454-02	484	30-10568-09	489
30-10368-13	477	30-10454-03	484	30-10572-10	489
30-10372-01	478	30-10454-12	484	30-10576-10	489
30-10372-02	478	30-10454-23	484	30-10580-11	489
30-10372-03	478	30-10454-34	484	30-10584-11	489
30-10372-04	478	30-10454-45	484	30-10586-11	489
30-10372-05	478	30-10454-56	484	30-10590-01	489
30-10372-06	478	30-10454-67	484	30-10590-02	489
30-10376-01	479	30-10454-78	484	30-10594-10	490
30-10376-02	479	30-10458-05	485	30-10596-10	490
30-10380-01	479	30-10458-07	485	30-10600-09	490
30-10380-02	479	30-10458-10	485	30-10601-09	490
30-10380-03	479	30-10462-12	485	30-10604-10	490
30-10384-01	479	30-10466-12	485	30-10605-10	490
30-10388-01	480	30-10470-13	485	30-10608-10	490
30-10388-02	480	30-10474-12	485	30-10609-10	490
30-10388-03	480	30-10478-12	485	30-10612-10	490
30-10392-01	480	30-10482-01	485	30-10613-10	490
30-10392-02	480	30-10482-02	485	30-10616-10	491
30-10396-01	480	30-10486-01	485	30-10617-10	491
30-10396-02	480	30-10486-02	485	30-10620-10	491
30-10396-03	480	30-10490-12	485	30-10621-10	491
30-10400-01	481	30-10494-13	486	30-10624-09	491
30-10400-02	481	30-10495-13	486	30-10628-05	492
30-10400-03	481	30-10498-01	486	30-10628-07	492
30-10400-04	481	30-10498-02	486	30-10628-10	492
30-10400-05	481	30-10498-03	486	30-10632-09	492
30-10400-06	481	30-10500-13	486	30-10634-09	492
30-10400-07	481	30-10502-10	486	30-10638-07	493
30-10400-08	481	30-10506-10	486	30-10640-07	493
30-10401-06	481	30-10508-10	486	30-10642-10	493
30-10404-00	482	30-10510-10	486	30-10646-08	493
30-10406-00	482	30-10514-10	486	30-10648-08	493
30-10408-01	482	30-10516-10	486	30-10650-08	493
30-10408-02	482	30-10518-10	486	30-10652-08	493
30-10408-03	482	30-10520-10	486	30-10656-05	494
30-10408-04	482	30-10524-01	487	30-10656-07	494
30-10412-15	483	30-10524-02	487	30-10656-10	494
30-10412-20	483	30-10524-03	487	30-10657-05	494
30-10416-01	483	30-10524-04	487	30-10657-07	494
30-10416-02	483	30-10524-05	487	30-10657-10	494
30-10420-16	483	30-10524-06	487	30-10660-05	494
30-10422-16	483	30-10528-01	487	30-10660-07	494
30-10426-13	483	30-10528-02	487	30-10660-10	494
30-10430-01	483	30-10528-03	487	30-10661-05	494
30-10430-02	483	30-10528-04	487	30-10661-07	494
30-10430-03	483	30-10528-05	487	30-10661-10	494
30-10434-12	484	30-10528-06	487	30-10664-08	494
30-10438-10	484	30-10528-07	487	30-10668-08	494
30-10442-01	484	30-10527-08	487	30-10668-08	494
30-10446-01	484	30-10528-09	487	30-10669-08	494
30-10446-02	484	30-10528-10	487	30-10672-10	495
30-10450-01	484	30-10528-11	487	30-10673-10	495
30-10450-02	484	30-10532-01	487	30-10675-10	495
30-10450-03	484	30-10532-02	487	30-10678-10	495
30-10450-04	484	30-10532-03	487	30-10679-10	495
30-10450-11	484	30-10532-04	487	30-10681-10	495
30-10450-22	484	30-10532-05	487	30-10684-10	495
30-10450-33	484	30-10532-06	487	30-10685-10	495
30-10450-44	484	30-10532-07	487	30-10687-10	495
30-10450-55	484	30-10532-08	487	30-10690-10	495
30-10450-66	484	30-10532-09	487	30-10691-10	495
30-10450-77	484	30-10532-10	487	30-10693-10	495
30-10450-88	484	30-10532-11	487	30-10696-10	495
30-10452-00	484	30-10532-12	487	30-10700-11	495
30-10452-01	484	30-10532-13	487	30-10701-11	495
30-10452-02	484	30-10532-14	487	30-10705-07	496
30-10452-03	484	30-10532-15	487	30-10707-07	496
30-10452-12	484	30-10536-00	487	30-10711-07	496
30-10452-23	484	30-10536-01	487	30-10713-07	496
30-10452-34	484	30-10536-02	487	30-10717-01	496
30-10452-45	484	30-10540-10	488	30-10717-02	496
30-10452-56	484	30-10544-08	488	30-10721-07	496
		30-10548-10	488	30-10723-07	496

31

Cat #	Pg #	Cat #	Pg #	Cat #	Pg #
31-10928-00	506	31-11018-60	511		
31-10932-30	506	31-11022-00	512		
31-10932-40	506	31-11022-01	512		
31-10932-50	506	31-11022-40	512		
31-10936-33	506	31-11022-45	512		
31-10940-20	506	31-11022-50	512		
31-10944-21	506	31-11022-55	512		
31-10948-00	507	31-11022-60	512		
31-10952-00	507	31-11026-00	512		
31-10956-00	507	31-11026-01	512		
31-10960-00	507	31-11026-40	512		
31-10964-00	508	31-11026-45	512		
31-10968-15	508	31-11026-50	512		
31-10968-19	508	31-11026-55	512		
31-10972-14	508	31-11026-60	512		
31-10976-40	509	31-11030-16	513		
31-10976-45	509	31-11032-27	513		
31-10976-50	509	31-11036-15	513		
31-10976-55	509	31-11040-16	513		
31-10976-60	509	31-11044-00	514		
31-10978-40	509	31-11044-01	514		
31-10978-45	509	31-11044-50	514		
31-10978-50	509	31-11044-60	514		
31-10978-55	509	31-11044-70	514		
31-10978-60	509	31-11046-00	514		
31-10980-40	509	31-11046-01	514		
31-10980-45	509	31-11046-50	514		
31-10980-50	509	31-11046-60	514		
31-10980-55	509	31-11046-70	514		
31-10980-60	509	31-11050-01	515		
31-10982-50	509	31-11050-02	515		
31-10982-55	509	31-11050-03	515		
31-10982-60	509	31-11052-01	515		
31-10984-35	509	31-11052-02	515		
31-10984-40	509	31-11052-03	515		
31-10984-45	509	31-11054-01	515		
31-10984-50	509	31-11054-02	515		
31-10984-55	509	31-11054-03	515		
31-10984-60	509	31-11056-01	515		
31-10984-65	509	31-11056-02	515		
31-10984-70	509	31-11056-03	515		
31-10986-35	509	31-11060-00	516		
31-10986-40	509	31-11060-01	516		
31-10986-45	509	31-11060-21	516		
31-10986-50	509	31-11060-22	516		
31-10986-55	509	31-11060-23	516		
31-10986-60	509	31-11062-00	516		
31-10986-65	509	31-11062-01	516		
31-10986-70	509	31-11064-00	516		
31-10988-35	509	31-11064-01	516		
31-10988-40	509	31-11066-00	516		
31-10988-45	509	31-11066-01	516		
31-10988-50	509	31-11070-24	517		
31-10988-55	509	31-11074-25	517		
31-10988-60	509	31-11078-15	517		
31-10988-65	509	31-11080-15	517		
31-10988-70	509	31-11082-15	517		
31-10990-50	509	31-11086-16	517		
31-10992-70	509	31-11090-01	517		
31-10994-01	510	31-11090-02	517		
31-10998-00	510	31-11090-03	517		
31-10998-01	510	31-11090-04	517		
31-10998-05	510	31-11090-05	517		
31-11002-00	510	31-11094-21	518		
31-11002-01	510	31-11098-22	518		
31-11006-00	510	31-11102-25	518		
31-11006-01	510	31-11106-20	518		
31-11010-00	511	31-11108-20	518		
31-11010-01	511	31-11112-21	518		
31-11014-00	511	31-11116-21	519		
31-11014-01	511	31-11120-18	519		
31-11018-00	511	31-11120-24	519		
31-11018-01	511	31-11124-19	519		
31-11018-40	511	31-11124-24	519		
31-11018-45	511	31-11128-20	519		
31-11018-50	511	31-11132-21	519		
31-11018-55	511	31-11136-17	520		

31

Cat #	Pg #	Cat #	Pg #	Cat #	Pg #	Cat #	Pg #	Cat #	Pg #	Cat #	Pg #
31-11136-20	520	31-11244-03	526	31-11298-03	529	31-11358-03	533	32-11426-03	539	32-11478-02	547
31-11136-28	520	31-11244-05	526	31-11298-05	529	31-11360-01	533	32-11428-01	539	32-11478-03	547
31-11140-01	520	31-11246-03	526	31-11300-03	529	31-11360-02	533	32-11428-02	539	32-11478-04	547
31-11140-02	520	31-11246-05	526	31-11300-05	529	31-11360-03	533	32-11428-03	539	32-11478-05	547
31-11140-03	520	31-11248-03	526	31-11302-03	529	31-11362-01	533	32-11428-04	539	32-11482-01	548
31-11140-04	520	31-11248-05	526	31-11302-05	529	31-11362-02	533	32-11430-01	540	32-11482-02	548
31-11142-01	520	31-11250-03	526	31-11304-03	529	31-11362-03	533	32-11430-02	540	32-11482-03	548
31-11142-02	520	31-11250-05	526	31-11304-05	529	31-11364-01	533	32-11430-03	540	32-11482-04	548
31-11142-03	520	31-11252-00	526	31-11304-03	529	31-11364-02	533	32-11432-00	541	32-11482-05	548
31-11142-04	520	31-11252-01	526	31-11304-05	529	31-11364-03	533	32-11432-01	541	32-11482-06	548
31-11144-08	520	31-11252-02	526	31-11306-03	529	31-11366-01	533	32-11432-02	541	32-11482-07	548
31-11144-11	520	31-11252-03	526	31-11306-05	529	31-11366-02	533	32-11432-03	541	32-11482-08	548
31-11144-14	520	31-11252-04	526	31-11310-01	530	31-11366-03	533	32-11432-04	541	32-11484-01	548
31-11144-17	520	31-11252-05	526	31-11310-02	530	31-11368-01	533	32-11434-01	541	32-11484-02	548
31-11144-20	520	31-11254-00	526	31-11310-03	530	31-11368-02	533	32-11434-02	541	32-11484-03	548
31-11144-25	520	31-11254-01	526	31-11312-01	530	31-11368-03	533	32-11434-03	541	32-11484-04	548
31-11148-08	520	31-11254-02	526	31-11312-02	530	31-11370-01	533	32-11434-04	541	32-11484-05	548
31-11148-11	520	31-11254-03	526	31-11312-03	530	31-11370-02	533	32-11348-01	542	32-11484-06	548
31-11148-14	520	31-11254-04	526	31-11314-01	530	31-11370-03	533	32-11438-02	542	32-11484-07	548
31-11148-17	520	31-11254-05	526	31-11314-02	530	31-11372-01	533	32-11438-03	542	32-11484-08	548
31-11152-09	521	31-11256-00	526	31-11314-03	530	31-11372-02	533	32-11438-04	542	32-11488-01	549
31-11152-13	521	31-11256-01	526	31-11316-01	530	31-11372-03	533	32-11438-05	542	32-11488-02	549
31-11152-18	521	31-11256-02	526	31-11316-02	530	31-11374-01	533	32-11440-01	542	32-11488-03	549
31-11152-22	521	31-11256-03	526	31-11316-03	530	31-11374-02	533	32-11440-02	542	32-11488-04	549
31-11156-12	521	31-11256-04	526	31-11318-01	530	31-11374-03	533	32-11440-03	542	32-11488-05	549
31-11156-17	521	31-11256-05	526	31-11318-02	530	31-11376-01	533	32-11440-04	542	32-11488-06	549
31-11160-14	521	31-11260-03	527	31-11318-03	530	31-11376-02	533	32-11444-01	543	32-11488-07	549
31-11160-17	521	31-11260-05	527	31-11320-01	530	31-11376-03	533	32-11444-02	543	32-11488-08	549
31-11160-20	521	31-11262-03	527	31-11320-02	530	31-11378-02	534	32-11448-01	543	32-11488-09	549
31-11164-01	521	31-11262-05	527	31-11320-03	530	31-11378-03	534	32-11448-02	543	32-11488-10	549
31-11164-02	521	31-11264-03	527	31-11322-01	530	31-11378-04	534	32-11448-03	543	32-11488-11	549
31-11164-03	521	31-11264-05	527	31-11322-02	530	31-11382-16	534	32-11448-04	543	32-11488-12	549
31-11168-21	521	31-11266-03	527	31-11322-03	530	31-11386-35	535	32-11450-01	543	32-11488-13	549
31-11172-03	522	31-11266-05	527	31-11324-01	530	31-11390-65	535	32-11450-02	543	32-11488-14	549
31-11172-05	522	31-11268-03	527	31-11324-02	530	31-11392-90	535	32-11450-03	543	32-11492-01	550
31-11172-07	522	31-11268-05	527	31-11324-03	530	31-11396-01	536	32-11450-04	543	32-11492-02	550
31-11174-03	522	31-11270-03	527	31-11326-01	530	31-11396-02	536	32-11454-11	544	32-11492-03	550
31-11174-05	522	31-11270-05	527	31-11326-02	530	31-11396-03	536	32-11456-10	544	32-11492-04	550
31-11174-07	522	31-11272-03	527	31-11326-03	530	31-11396-04	536	32-11456-18	544	32-11492-05	550
31-11177-07	522	31-11272-05	527	31-11330-01	531	31-11396-05	536	32-11460-05	544	32-11492-06	550
31-11177-09	522	31-11274-03	527	31-11330-02	531	31-11398-01	536	32-11460-10	544	32-11494-01	550
31-11179-07	522	31-11274-05	527	31-11330-03	531	31-11398-02	536	32-11460-15	544	32-11494-02	550
31-11179-08	522	31-11278-03	528	31-11332-01	531	31-11398-03	536	32-11464-01	544	32-11494-03	550
31-11180-07	523	31-11278-04	528	31-11332-02	531	31-11398-04	536	32-11464-02	544	32-11494-04	550
31-11180-10	523	31-11278-05	528	31-11332-03	531	31-11398-05	536	32-11464-03	544	32-11494-05	550
31-11182-01	523	31-11278-05	528	31-11334-01	531	31-11402-01	536	32-11470-01	545	32-11494-06	550
31-11182-02	523	31-11280-03	528	31-11334-02	531	31-11402-02	536	32-11470-02	545	32-11496-01	550
31-11182-03	523	31-11280-04	528	31-11334-03	531	31-11402-03	536	32-11470-03	545	32-11496-02	550
31-11182-04	523	31-11280-05	528	31-11336-01	531	31-11402-04	536	32-11470-04	545	32-11496-03	550
31-11184-19	523	31-11282-03	528	31-11336-02	531	31-11402-05	536	32-11470-05	545	32-11496-04	550
31-11184-28	523	31-11282-04	528	31-11336-03	531	31-11404-01	536	32-11470-06	545	32-11496-05	550
31-11188-17	523	31-11282-05	528	31-11338-01	531	31-11404-02	536	32-11470-07	545	32-11496-06	550
31-11188-21	523	31-11284-03	528	31-11338-02	531	31-11404-03	536	32-11470-08	545	32-11500-01	551
31-11188-14	523	31-11284-04	528	31-11338-03	531	31-11404-04	536	32-11470-09	545	32-11500-02	551
31-11190-14	523	31-11284-05	528	31-11340-01	531	31-11404-05	536	32-11470-10	545	32-11500-03	551
31-11192-01	523	31-11286-02	528	31-11340-02	531	31-11408-01	537	32-11470-11	545	32-11500-04	551
31-11192-02	523	31-11286-03	528	31-11340-03	531	31-11408-02	537	32-11470-12	545	32-11500-05	551
31-11196-16	524	31-11286-04	528	31-11342-01	531	31-11408-03	537	32-11470-13	545	32-11502-01	551
31-11200-22	524	31-11286-05	528	31-11342-02	531	31-11408-04	537	32-11470-14	545	32-11502-02	551
31-11204-01	524	31-11288-02	528	31-11342-03	531	31-11412-16	537	32-11470-15	545	32-11504-01	551
31-11204-02	524	31-11288-03	528	31-11344-01	531			32-11474-01	546	32-11504-02	551
31-11204-03	524	31-11288-04	528	31-11344-02	531			32-11474-02	546	32-11508-01	552
31-11208-29	524	31-11288-05	528	31-11344-03	531			32-11474-03	546	32-11508-02	552
31-11212-30	524	31-11288-06	528	31-11346-01	531	32-11416-01	538	32-11474-04	546	32-11508-03	552
31-11214-30	524	31-11290-02	528	31-11346-02	531	32-11416-02	538	32-11474-05	546	32-11508-04	552
31-11218-16	525	31-11290-03	528	31-11346-03	531	32-11416-03	538	32-11474-06	546	32-11508-05	552
31-11222-15	525	31-11290-04	528	31-11350-01	532	32-11418-01	538	32-11474-07	546	32-11508-06	552
31-11226-13	525	31-11290-05	528	31-11350-02	532	32-11418-02	538	32-11474-08	546	32-11508-07	552
31-11226-18	525	31-11290-06	528	31-11350-03	532	32-11420-01	538	32-11474-09	546	32-11508-08	552
31-11230-13	525	31-11292-02	528	31-11352-01	532	32-11420-02	538	32-11474-10	546	32-11508-09	552
31-11230-18	525	31-11292-03	528	31-11352-02	532	32-11420-03	538	32-11474-11	546	32-11508-10	552
31-11234-23	525	31-11292-04	528	31-11352-03	532	32-11420-04	538	32-11474-12	546	32-11508-11	552
31-11236-20	525	31-11292-05	528	31-11354-01	532	32-11424-01	539	32-11474-13	546	32-11508-12	552
31-11240-03	526	31-11292-06	528	31-11354-02	532	32-11424-02	539	32-11474-14	546	32-11508-13	552
31-11242-03	526	31-11296-03	529	31-11354-03	532	32-11424-03	539	32-11474-15	546	32-11512-03	553
31-11242-05	526	31-11296-05	529	31-11358-01	533	32-11426-01	539	32-11474-16	546	32-11512-04	553
				31-11358-02	533	32-11426-02	539	32-11478-01	547	32-11512-05	553

32

Crown Click International

CATALOGUE



**SURGICAL
INSTRUMENTS**