

Anaesthesia Instruments



www.Crown Click Intl.com





CROWN CLICK

INTERNATIONAL

CERTIFICATE



Dynamex Certification Services certify that
CROWN CLICK INTERNATIONAL

Registration No. DCS/2232-A

Address to which this certificate refers:

Mehran Street, Mohallah Prem Nagar, Sialkot, (51310) – Pakistan.

Approved Scope to which this certificate refers:

“Manufacturer and Exporter of Surgical & Dental Instruments”

has been evaluated and found to meet the requirements of

ISO 9001: 2015

CHAIRMAN

SCHEME MANAGER

Certificate Issue Date: 08 August, 2024

Certificate Expiry Date: 07 August, 2025

Date of Initial Registration: 08 August, 2024

Re-assessment Date: 07 August, 2027

This Certificate of Registration is granted subject to the Regulations approved by the Board

www.dynamexcertification.org

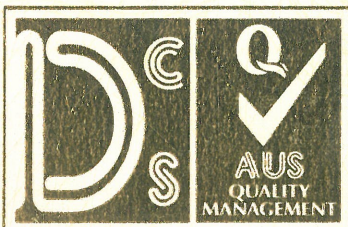

CE Compliance Certificate



Application of Medical Device Regulation MDR 2017/ 745 for Class I Medical Devices.

This is to certify that the products submitted are:

**MEDICAL DEVICES CLASS I
(Re-Useable Surgical and Dental Instruments)
Registration no DCS/1248322558-A**

Manufactured By:

CROWN CLICK INTERNATIONAL

Mehran Street, Mohallah Prem Nagar, Sialkot, 51310 – Pakistan.

Comply with the applicable requirements of the MDR 2017/ 745, The Technical file of the devices have been assessed, including the EC declaration of conformity according to the Annex IV confirming that the medical devices are fulfilling the applicable requirements of MDR 2017/745.

Limitations:

The manufacturer must inform DCS of any substantial changes occurred in the Product or process in order to examine whether this certificate remains valid.

CHAIRMAN

SCHEME MANAGER

Certificate Issue Date: August 08, 2024

Certificate Expiry Date: August 07, 2025

This Certificate of Registration is granted subject to the Regulations approved by the Board

www.dynamexcertification.org

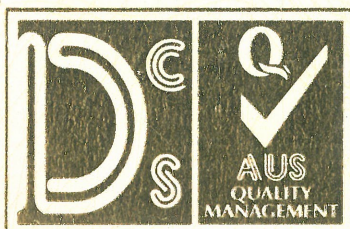

CERTIFICATE



Dynamex Certification Services certify that
CROWN CLICK INTERNATIONAL

Registration No. DCS/2232-B

Address to which this certificate refers:

Mehran Street, Mohallah Prem Nagar, Sialkot, (51310) – Pakistan.

Approved Scope to which this certificate refers:

“Manufacturer and Exporter of Surgical & Dental Instruments”

has been evaluated and found to meet the requirements of

ISO 13485: 2016

CHAIRMAN

SCHEME MANAGER

Certificate Issue Date: 08 August, 2024

Certificate Expiry Date: 07 August, 2025

Date of Initial Registration: 08 August, 2024

Re-assessment Date: 07 August, 2027

This Certificate of Registration is granted subject to the Regulations approved by the Board

www.dynamexcertification.org





"Businesses require 'Continuous Professional Development' at each activity process to ensure quality growth in its operations. We utilise the years of experience with assistance of the information technology to evaluate and improve year by year. Our aim is to supply our customers with best quality and to bring revolutionary solutions to healthcare industry. We are confident that with our carefully selected team, and their hardwork, we would be able to reach our target and become the best possible source for healthcare equipment from Sialkot, Pakistan."

ANESTHESIA

MACINTOSH

Conventional

	Fig.	Working Length (mm)	Spare Lamp
12-01110-55	a	55	12-01100-01
12-01110-70	1	70	12-01100-02
12-01110-78	2	78	12-01100-02
12-01110-90	2	90	12-01100-02
12-01110-10	3	108	12-01100-02
12-01110-13	4	133	12-01100-02
12-01110-15	5	150	12-01100-02

AMERICAN MACINTOSH

Conventional

	Fig.	Working Length (mm)	Spare Lamp
12-01120-65	0	65	12-01100-01
12-01120-66	1	66	12-01100-01
12-01120-86	2	86	12-01100-01
12-01120-10	3	107	12-01100-02
12-01120-12	3,5	123	12-01100-02
12-01120-13	4	134	12-01100-02

MILLER

Conventional

	Fig.	Working Length (mm)	Spare Lamp
12-01130-45	DO	45	12-01100-01
12-01130-55	0	55	12-01100-01
12-01130-80	1	80	12-01100-01
12-01130-13	2	130	12-01100-02
12-01130-17	3	170	12-01100-02
12-01130-18	4	180	12-01100-02

AMERICAN MILLER

Conventional

	Fig.	Working Length (mm)	Spare Lamp
12-01130-55	0	55	12-01100-01
12-01130-80	1	80	12-01100-01
12-01140-13	2	132	12-01100-01
12-01140-17	3	172	12-01100-01
12-01140-18	4	182	12-01100-02

WISCONSIN FOREGOER

Conventional

	Fig.	Working Length (mm)	Spare Lamp
12-01150-71	1	71	12-01100-01
12-01150-90	2	90	12-01100-01
12-01150-11	3	110	12-01100-02
12-01150-13	4	137	12-01100-02

GUEDEL NEAGUS

Conventional

	Fig.	Working Length (mm)	Spare Lamp
12-01160-72	1	72	12-01100-02
12-01160-95	2	95	12-01100-02
12-01160-11	3	111	12-01100-02
12-01160-13	4	135	12-01100-02



ANESTHESIA

MACINTOSH (Cold Light Guide - Fixed)

Fiber Optic

	Fig.	Working Length (mm)
12-01210-55	0	55
12-01210-70	1	70
12-01210-78	2	78
12-01210-90	2	90
12-01210-10	3	108
12-01210-13	4	133
12-01210-15	5	150



AMERICAN MACINTOSH (Cold Light Guide- Fixed)

Fiber Optic

	Fig.	Working Length (mm)
12-01220-65	0	65
12-01220-66	1	66
12-01220-86	2	86
12-01220-10	3	107
12-01220-12	3.5	123
12-01220-13	4	134



MILLER (Cold Light Guide - Fixed)

Fiber Optic

	Fig.	Working Length (mm)
12-01230-45	00	45
12-01230-55	0	55
12-01230-80	1	80
12-01230-13	2	130
12-01230-17	3	170
12-01230-18	4	180



AMERICAN MILLER (Cold Light Guide - Fixed)

Fiber Optic

	Fig.	Working Length (mm)
12-01230-55	0	55
12-01230-80	1	80
12-01240-13	2	132
12-01240-17	3	172
12-01240-18	4	182



WISCONSIN FOREGGER (Cold Light Guide Fixed)

Fiber Optic

	Fig.	Working Length (mm)
12-01250-71	1	71
12-01250-90	2	90
12-01250-11	3	110
12-01250-13	4	137



GUEDEL NEAGUS (Cold Light Guide Fixed)

Fiber Optic

	Fig.	Working Length (mm)
12-01260-72	1	72
12-01260-95	2	95
12-01260-11	3	111
12-01260-13	4	135



ANESTHESIA

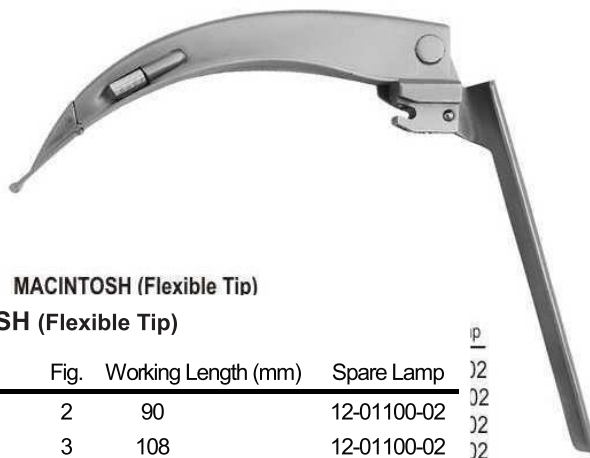

MACINTOSH (Flexible Tip)

MACINTOSH (Flexible Tip)

Conventional

	Fig.	Working Length (mm)	Spare Lamp	φ
12-01310-90	2	90	12-01100-02	∅2
12-01310-10	3	108	12-01100-02	∅2
12-01310-13	4	133	12-01100-02	∅2
12-01310-15	5	150	12-01100-02	∅2



L



MACINTOSH (Flexible Tip)

Fiber Optic

	Fig.	Working Length (mm)
04.1410.90	2	90

MACINTOSH (Flexible Tip)

Fiber Optic

	Fig.	Working Length (mm)
12-01410-90	2	90
12-01410-10	3	108
12-01410-13	4	133
12-01410-15	5	150

ANESTHESIA

MACINTOSH (Cold Light Guide - Interchangeable)

Fiber Optic

	Fig.	Working Length (mm)	Spare Insert
12-01510-55	0	55	12-01510-01
12-01510-70	1	70	12-01510-02
12-01510-78	2	78	12-01510-03
12-01510-90	2	90	12-01510-04
12-01510-10	3	108	12-01510-05
12-01510-13	4	133	12-01510-06
12-01510-15	5	150	12-01510-07



AMERICAN MACINTOSH (Cold Light Guide- Interchangeable)

Fiber Optic

	Fig.	Working Length (mm)	Spare Insert
12-01520-65	0	65	12-01520-01
12-01520-66	1	66	12-01520-02
12-01520-86	2	86	12-01520-03
12-01520-10	3	107	12-01520-04
12-01520-12	3.5	123	12-01520-05
12-01520-13	4	134	12-01520-06



MILLER (Cold Light Guide - Interchangeable)

Fiber Optic

	Fig.	Working Length (mm)	Spare Insert
12-01530-45	00	45	12-01530-01
12-01530-55	0	56	12-01530-02
12-01530-80	1	80	12-01530-03
12-01530-13	2	130	12-01530-04
12-01530-17	3	170	12-01530-05
12-01530-18	4	180	12-01530-06



AMERICAN MILLER (Cold Light Guide - Interchangeable)

Fiber Optic

	Fig.	Working Length (mm)	Spare Insert
12-01530-55	0	55	12-01530-02
12-01530-80	1	80	12-01530-03
12-01540-13	2	132	12-01540-01
12-01540-17	3	172	12-01540-02
12-01540-18	4	182	12-01540-03



WISCONSIN FOREGGER (Cold Light Guide - Interchangeable)

Fiber Optic

	Fig.	Working Length (mm)	Spare Insert
12-01550-70	1	71	12-01550-01
12-01550-90	2	90	12-01550-02
12-01550-11	3	110	12-01550-03
12-01550-13	4	137	12-01550-04



GUEDEL NEAGUS (Cold Light Guide - Interchangeable)

Fiber Optic

	Fig.	Working Length (mm)	Spare Insert
12-01560-72	1	72	12-01560-01
12-01560-95	2	95	12-01560-02
12-01560-11	3	111	12-01560-03
12-01560-13	4	135	12-01560-04



ANESTHESIA



Conventional Handles

	Size	Batteries
12-02100-01	Medium/Standard	2C
12-02100-02	Small/Penlight	2AA
12-02100-03	stubby	2AA
12-02100-04	Large	2D

Fiber Optic Handles

	Size	Batteries
12-02200-01	Medium/Standard	2C
12-02200-02	Small/Penlight	2M
12-02200-03	Stubby	2AA
12-02200-04	Large	2D

Plastic Disposable Fiber Optic Handles

12-02300-01	Medium/Standard Plastic	-
12-02400-01	Medium/Standard	



12-01100-01
Small Spare Lamp For Conventional Blades



12-02200-01
Spare Lamp For Fiber Optic Handles



12-01100-02
Large Spare Lamp For Conventional Blades

ANESTHESIA



Macintosh Laryngoscope sets Conventional

12-04110-01 Complete Set With 3 Blades Consisting
 12-04001-00 Plastic hard case, Small
 12-02100-01 1 Handle, Medium
 12-01110-70 1 Blade Macintosh Fig.1
 12-01110-78 1 Blade Macintosh Fig.2 (78mm)
 12-01110-10 1 Blade Macintosh Fig.3

12-04110-02 Complete Set With 3 Blades Consisting
 12-04001-00 Plastic hard case, Small
 12-02100-01 1 Handle, Medium
 12-01110-70 1 Blade Macintosh Fig.1
 12-01110-90 1 Blade Macintosh Fig.2 (90mm)
 12-01110-10 1 Blade Macintosh Fig.3

12-04110-03 Complete Set With 3 Blades Consisting
 12-04001-00 Plastic hard case, Small
 12-02100-01 1 Handle, Medium
 12-01110-78 1 Blade Macintosh Fig.2 (78mm)
 12-01110-10 1 Blade Macintosh Fig.3
 12-01110-13 1 Blade Macintosh Fig.4

12-04110-04 Complete Set With 3 Blades Consisting
 12-04001-00 Plastic hard case, Small
 12-02100-01 1 Handle, Medium
 12-01110-90 1 Blade Macintosh Fig.2 (90mm)
 12-01110-10 1 Blade Macintosh Fig.3
 12-01110-13 1 Blade Macintosh FigA

Macintosh Laryngoscope sets Conventional

12-05110-01 Complete Set With 3 Blades Consisting
 12-05004-00 Soft pouch with 4 Pockets
 12-02100-01 1 Handle, Medium
 12-01110-70 1 Blade Macintosh Fig.1
 12-01110-78 1 Blade Macintosh Fig.2 (78mm)
 12-01110-10 1 Blade Macintosh Fig.3

12-05110-02 Complete Set With 3 Blades Consisting
 12-05004-00 Soft pouch with 4 Pockets
 12-02100-01 1 Handle, Medium
 12-01110-70 1 Blade Macintosh Fig.1
 12-01110-90 1 Blade Macintosh Fig.2 (90mm)
 12-01110-10 1 Blade Macintosh Fig.3

12-05110-03 Complete Set With 3 Blades Consisting
 12-05004-00 Soft pouch with 4 Pockets
 12-02100-01 1 Handle, Medium
 12-01110-78 1 Blade Macintosh Fig.2 (78mm)
 12-01110-10 1 Blade Macintosh Fig.3
 12-01110-13 1 Blade Macintosh Fig.4

12-05110-04 Complete Set With 3 Blades Consisting
 12-05004-00 Soft pouch with 4 Pockets
 12-02100-01 1 Handle, Medium
 12-01110-90 1 Blade Macintosh Fig.2 (90mm)
 12-01110-10 1 Blade Macintosh Fig.3
 12-01110-13 1 Blade Macintosh Fig.4

ANESTHESIA



Macintosh Laryngoscope sets Conventional

12-04110-05 Complete Set With 4 Blades Consisting

- 12-04002-00 Plastic hard case, Large
- 12-02100-01 1 Handle, Medium
- 12-01110-70 1 Blade Macintosh Fig.1
- 12-01110-78 1 Blade Macintosh Fig.2 (78mm)
- 12-01110-10 1 Blade Macintosh Fig.3
- 12-01110-13 1 Blade Macintosh Fig.4

12-04110-06 Complete Set With 4 Blades Consisting

- 12-04002-00 Plastic hard case, Large
- 12-02100-01 1 Handle, Medium
- 12-01110-70 1 Blade Macintosh Fig.1
- 12-01110-90 1 Blade Macintosh Fig.2 (90mm)
- 12-01110-10 1 Blade Macintosh Fig.3
- 12-01110-13 1 Blade Macintosh Fig.4

12-04110-07 Complete Set With 5 Blades Consisting

- 12-04002-00 Plastic hard case, Large
- 12-02100-01 1 Handle, Medium
- 12-01110-55 1 Blade Macintosh Fig.0
- 12-01110-70 1 Blade Macintosh Fig.1
- 12-01110-78 1 Blade Macintosh Fig.2 (78mm)
- 12-01110-10 1 Blade Macintosh Fig.3
- 12-01110-13 1 Blade Macintosh Fig.4

12-04110-08 Complete Set With 5 Blades Consisting

- 12-04002-00 Plastic hard case, Large
- 12-02100-01 1 Handle, Medium
- 12-01110-55 1 Blade Macintosh Fig.0
- 12-01110-70 1 Blade Macintosh Fig.1
- 12-01110-90 1 Blade Macintosh Fig.2 (90mm)
- 12-01110-10 1 Blade Macintosh Fig.3
- 12-01110-13 1 Blade Macintosh Fig.4



Macintosh Laryngoscope sets Conventional

12-05110-05 Complete Set With 4 Blades Consisting

- 12-05005-00 Soft pouch with 5 Pockets
- 12-02100-01 1 Handle, Medium
- 12-01110-70 1 Blade Macintosh Fig.1
- 12-01110-78 1 Blade Macintosh Fig.2 (78mm)
- 12-01110-10 1 Blade Macintosh Fig.3
- 12-01110-13 1 Blade Macintosh Fig.4

12-05110-06 Complete Set With 4 Blades Consisting

- 12-05005-00 Soft pouch with 5 Pockets
- 12-02100-01 1 Handle, Medium
- 12-01110-70 1 Blade Macintosh Fig.1
- 12-01110-90 1 Blade Macintosh Fig.2 (90mm)
- 12-01110-10 1 Blade Macintosh Fig.3
- 12-01110-13 1 Blade Macintosh Fig.4

12-05110-07 Complete Set With 5 Blades Consisting

- 12-05006-00 Soft pouch with 6 Pockets
- 12-02100-01 1 Handle, Medium
- 12-01110-55 1 Blade Macintosh Fig.D
- 12-01110-70 1 Blade Macintosh Fig.1
- 12-01110-78 1 Blade Macintosh Fig.2 (78mm)
- 12-01110-10 1 Blade Macintosh Fig.3
- 12-01110-13 1 Blade Macintosh Fig.4

12-05110-08 Complete Set With 5 Blades Consisting

- 12-05006-00 Soft pouch with 6 Pockets
- 12-02100-01 1 Handle, Medium
- 12-01110-55 1 Blade Macintosh Fig.0
- 12-01110-70 1 Blade Macintosh Fig.1
- 12-01110-90 1 Blade Macintosh Fig.2 (90mm)
- 12-01110-10 1 Blade Macintosh Fig.3
- 12-01110-13 1 Blade Macintosh Fig.4

ANESTHESIA



Miller Laryngoscope sets Conventional

- 12-04130-01** Complete Set With 5 Blades Consisting
 12-04002-00 Plastic hard case. Large
 12-02100-01 1 Handle, Small
 12-01130-55 1 Blade Miller Fig.0
 12-01130-80 1 Blade Miller Fig.1
 12-01130-13 1 Blade Miller Fig.2
 12-01130-17 1 Blade Miller Fig.3
 12-01130-18 1 Blade Miller Fig.4

- 12-04130-02** Complete Set With 2 Blades Consisting
 12-04001-00 Plastic hard case. Small
 12-02100-02 1 Handle, Small
 12-01130-55 1 Blade Miller Fig.0
 12-01130-80 1 Blade Miller Fig.1

- 12-4130-03** Complete Set With 2 Blades Consisting
 12-04001-00 Plastic hard case. Small
 12-02100-02 1 Handle, Small
 12-01130-45 1 Blade Miller Fig.00
 12-01130-55 1 Blade Miller Fig.0

- 12-04130-04** Complete Set With 3 Blades Consisting
 12-04001-00 Plastic hard case. Small
 12-02100-02 1 Handle, Small
 12-01130-45 1 Blade Miller Fig.00
 12-01130-55 1 Blade Miller Fig.0
 12-01130-80 1 Blade Miller Fig.1

- 12-04130-05** Complete Set With 3 Blades Consisting
 12-04001-00 Plastic hard case. Small
 12-02100-01 1 Handle, Medium
 12-01130-55 1 Blade Miller Fig.0
 12-01130-80 1 Blade Miller Fig.1
 12-01130-13 1 Blade Miller Fig.2

- 12-04130-06** Complete Set With 3 Blades Consisting
 12-04001-00 Plastic hard case. Small
 12-02100-02 1 Handle, Small
 12-01130-55 1 Blade Miller Fig.0
 12-01130-80 1 Blade Miller Fig.1
 12-01110-55 1 Blade Macintosh Fig.0

Miller Laryngoscope sets Conventional

- 12-05130-01** Complete Set With 5 Blades Consisting
 12-05006-00 Soft pouch with 8 Pockets
 12-02100-01 1 Handle, Medium
 12-01130-55 1 Blade Miller Fig.0
 12-01130-80 1 Blade Miller Fig.1
 12-01130-13 1 Blade Miller Fig.2
 12-01130-17 1 Blade Miller Fig.3
 12-01130-18 1 Blade Miller Fig.4

- 12-05130-02** Complete Set With 2 Blades Consisting
 12-05003-00 Soft pouch with 3 Pockets
 12-02100-02 1 Handle, Small
 12-01130-55 1 Blade Miller Fig.0
 12-01130-80 1 Blade Miller Fig.1

- 12-05130-03** Complete set with 2 blades consisting
 12-05003-00 Soft pouch with 3 Pockets
 12-02100-02 1 Handle, Small
 12-01130-45 1 Blade Miller Fig.00
 12-01130-55 1 Blade Miller Fig.0

- 12-05130-04** Complete Set With 3 Blades Consisting
 12-05004-00 Soft pouch with 4 Pockets
 12-02100-02 1 Handle, Small
 12-01130-45 1 Blade Miller Fig.00
 12-01130-55 1 Blade Miller Fig.0
 12-01130-80 1 Blade Miller Fig.1

- 12-05130-05** Complete Set With 3 Blades Consisting
 12-05004-00 Soft pouch with 4 Pockets
 12-02100-01 1 Handle, Medium
 12-01130-55 1 Blade Miller Fig.0
 12-01130-80 1 Blade Miller Fig.1
 12-01130-13 1 Blade Miller Fig.2

- 12-05130-06** Complete Set With 3 Blades Consisting
 12-05004-00 Soft pouch with 4 Pockets
 12-02100-02 1 Handle, Small
 12-01130-55 1 Blade Miller Fig.0
 12-01130-80 1 Blade Miller Fig.1
 12-01110-55 1 Blade Macintosh Fig.0

ANESTHESIA



Macintosh Laryngoscope sets (Cold Light Guide - Fixed) Fiber Optic

- 12-04210-01** Complete Set With 3 Blades Consisting
 12-04001-00 Plastic hard case, Medium
 12-02200-01 1 Handle, Medium
 12-01210-70 1 Blade Macintosh Fig.1
 12-01210-78 1 Blade Macintosh Fig.2 (78mm)
 12-01210-10 1 Blade Macintosh Fig.3

- 12-04210-02** Complete Set With 3 Blades Consisting
 12-04001-00 Plastic hard Case, Small
 12-02200-01 1 Handle, Medium
 12-01210-70 1 Blade Macintosh Fig.1
 12-01210-90 1 Blade Macintosh Fig.2 (90mm)
 12-01210-10 1 Blade Macintosh Fig.3

- 12-04210-03** Complete Set With 3 Blades Consisting
 12-04001-00 Plastic hard Case, Small
 12-02200-01 1 Handle, Medium
 12-01210-78 1 Blade Macintosh Fig.2 (78mm)
 12-01210-10 1 Blade Macintosh Fig.3
 12-01210-13 1 Blade Macintosh Fig.4

- 12-04210-04** Complete Set With 3 Blades Consisting
 12-04001-00 Plastic hard case, Small
 12-02200-01 1 Handle, Medium
 12-01210-90 1 Blade Macintosh Fig.2 (90mm)
 12-01210-10 1 Blade Macintosh Fig.3
 12-01210-13 1 Blade Macintosh Fig.4

Macintosh Laryngoscope sets (Cold Light Guide - Fixed) Fiber Optic

- 12-05210-01** Complete Set With 3 Blades Consisting
 12-05004-00 Soft pouch with 4 Pockets
 12-02200-01 1 Handle, Medium
 12-01210-70 1 Blade Macintosh Fig.1
 12-01210-78 1 Blade Macintosh Fig.2 (78mm)
 12-01210-10 1 Blade Macintosh Fig.3

- 12-05210-02** Complete Set With 3 Blades Consisting
 12-05004-00 Soft pouch with 4 Pockets
 12-02200-01 1 Handle, Medium
 12-01210-70 1 Blade Macintosh Fig.1
 12-01210-80 1 Blade Macintosh Fig.2 (90mm)
 12-01210-10 1 Blade Macintosh Fig.3

- 12-05210-03** Complete Set With 3 Blades Consisting
 12-05004-00 Soft pouch with 4 Pockets
 12-02200-01 1 Handle, Medium
 12-01210-78 1 Blade Macintosh Fig.2 (78mm)
 12-01210-10 1 Blade Macintosh Fig.3
 12-01210-13 1 Blade Macintosh Fig.4

- 12-05210-04** Complete Set With 3 Blades Consisting
 12-05004-00 Soft pouch with 4 Pockets
 12-02200-01 1 Handle, Medium
 12-01210-80 1 Blade Macintosh Fig.2 (90mm)
 12-01210-10 1 Blade Macintosh Fig.3
 12-01210-13 1 Blade Macintosh Fig.4

ANESTHESIA



Macintosh Laryngoscope sets

(Cold Light Guide - Fixed)

Fiber Optic

- 12-04210-05** Complete Set With 4 Blades Consisting
 12-04002-00 Plastic hard case, Large
 12-02200-01 1 Handle, Medium
 12-01210-70 1 Blade Macintosh Fig.1
 12-01210-78 1 Blade Macintosh Fig.2 (78mm)
 12-01210-10 1 Blade Macintosh Fig.3
 12-01210-13 1 Blade Macintosh Fig.4

- 12-04210-06** Complete Set With 4 Blades Consisting
 12-04002-00 Plastic hard Case, Large
 12-02200-01 1 Handle, Medium
 12-01210-70 1 Blade Macintosh Fig.1
 12-01210-90 1 Blade Macintosh Fig.2 (90mm)
 12-01210-10 1 Blade Macintosh Fig.3
 12-01210-13 1 Blade Macintosh Fig.4

- 12-04210-07** Complete Set With 5 Blades Consisting
 12-04002-00 Plastic hard Case, Large
 12-02200-01 1 Handle, Medium
 12-01210-55 1 Blade Macintosh Fig.0
 12-01210-70 1 Blade Macintosh Fig.1
 12-01210-78 1 Blade Macintosh Fig.2 (78mm)
 12-01210-10 1 Blade Macintosh Fig.3
 12-01210-13 1 Blade Macintosh Fig.4

- 12-04210-08** Complete Set With 5 Blades Consisting
 12-04002-00 Plastic hard case, Large
 12-02200-01 1 Handle, Medium
 12-01210-55 1 Blade Macintosh Fig.0
 12-01210-70 1 Blade Macintosh Fig.1
 12-01210-90 1 Blade Macintosh Fig.2(90mm)
 12-01210-10 1 Blade Macintosh Fig.3
 12-01210-13 1 Blade Macintosh Fig.4

Macintosh Laryngoscope sets

(Cold Light Guide - Fixed)

Fiber Optic

- 12-05210-05** Complete Set With 4 Blades Consisting
 12-05005-00 Soft Pouch with 5 Pockets
 12-02200-01 1 Handle, Medium
 12-01210-70 1 Blade Macintosh Fig.1
 12-01210-78 1 Blade Macintosh Fig.2 (78mm)
 12-01210-10 1 Blade Macintosh Fig.3
 12-01210-13 1 Blade Macintosh Fig.4

- 12-05210-06** Complete Set With 4 Blades Consisting
 12-05005-00 Soft Pouch with 5 Pockets
 12-02200-01 1 Handle, Medium
 12-01210-70 1 Blade Macintosh Fig.1
 12-01210-90 1 Blade Macintosh Fig.2 (90mm)
 12-01210-10 1 Blade Macintosh Fig.3
 12-01210-13 1 Blade Macintosh Fig.4

- 12-05210-07** Complete Set With 5 Blades Consisting
 12-05006-00 Soft Pouch with 6 Pockets
 12-02200-01 1 Handle, Medium
 12-01210-55 1 Blade Macintosh Fig.0
 12-01210-70 1 Blade Macintosh Fig.1
 12-01210-78 1 Blade Macintosh Fig.2 (78mm)
 12-01210-10 1 Blade Macintosh Fig.3
 12-01210-13 1 Blade Macintosh Fig.4

- 12-05210-08** Complete Set With 5 Blades Consisting
 12-05006-00 Soft Pouch with 6 Pockets
 12-02200-01 1 Handle, Medium
 12-01210-55 1 Blade Macintosh Fig.0
 12-01210-70 1 Blade Macintosh Fig.1
 12-01210-90 1 Blade Macintosh Fig.2(90mm)
 12-01210-10 1 Blade Macintosh Fig.3
 12-01210-13 1 Blade Macintosh Fig.4



ANESTHESIA



Miller Laryngoscope sets (Cold Light Guide - Fixed) Fiber Optic

- 12-04230-01** Complete set with 5 blades consisting
 12-04002-00 Plastic hard case, Large
 12-02200-01 1 Handle, Medium
 12-01230-55 1 Blade Miller Fig.0
 12-01230-80 1 Blade Miller Fig.1
 12-01230-13 1 Blade Miller Fig.2
 12-01230-17 1 Blade Miller Fig.3
 12-01230-18 1 Blade Miller Fig.4

- 12-04230-02** Complete set with 2 blades consisting
 12-04001-00 Plastic hard Case, Small
 12-02200-02 1 Handle, Small
 12-01230-55 1 Blade Miller Fig.0
 12-01230-80 1 Blade Miller Fig.1

- 12-04230-03** Complete set with 2 blades consisting
 12-04001-00 Plastic hard Case, Small
 12-02200-02 1 Handle, Small
 12-01230-45 1 Blade Miller Fig.00
 12-01230-55 1 Blade Miller Fig.0



Miller Laryngoscope sets (Cold Light Guide - Fixed) Fiber Optic

- 12-05230-01** Complete set with 5 blades Consisting
 12-05006-00 Soft pouch with 6 Pockets
 12-02200-01 1 Handle, Medium
 12-01230-55 1 Blade Miller Fig.0
 12-01230-80 1 Blade Miller Fig.1
 12-01230-13 1 Blade Miller Fig.2
 12-01230-17 1 Blade Miller Fig.3
 12-01230-18 1 Blade Miller Fig.4

- 12-05230-02** Complete set with 2 blades consisting
 12-05003-00 Soft pouch with 3 Pockets
 12-02200-02 1 Handle, Small
 12-01230-55 1 Blade Miller Fig.0
 12-01230-80 1 Blade Miller Fig.1

- 12-05230-03** Complete set with 2 blades consisting
 12-05003-00 Soft pouch with 3 Pockets
 12-02200-02 1 Handle, Small
 12-01230-45 1 Blade Miller Fig.0D
 12-01230-55 1 Blade Miller Fig.0

ANESTHESIA



Macintosh Laryngoscope sets (Integrated Flexible Tip) Conventional

- 12-04310-01** Complete set with 1 blade consisting
 12-04002-00 Plastic hard case, Large 04.2100.01 1 Handle, Medium
 12-01310-90 1 Blade Macintosh Fig.2 (90mm)
- 12-04310-02** Complete set with 1 blade consisting
 12-04002-00 Plastic hard case, Large 04.2100.01 1 Handle, Medium
 12-01310-10 1 Blade Macintosh Fig.3
- 12-04310-03** Complete set with 1 blade consisting
 12-04002-00 Plastic hard case, Large 04.2100.01 1 Handle, Medium
 12-01310-13 1 Blade Macintosh Fig.A
- 12-04310-04** Complete set with 1 blade consisting
 12-04002-00 Plastic hard case, Large
 12-02100-01 1 Handle, Medium
 12-01310-15 1 Blade Macintosh Fig.5

Macintosh Laryngoscope sets (Integrated Flexible Tip) Conventional

- 12-04310-05** Complete set with 3 blades consisting
 12-04003-00 Plastic hard case, X-Large
 12-02100-01 1 Handle, Medium
 12-01310-90 1 Blade Macintosh Fig.2
 12-01310-10 1 Blade Macintosh Fig.3
 12-01310-13 1 Blade Macintosh Fig.4
- 12-04310-06** Complete set with 4 blades consisting
 12-04003-00 Plastic hard case, X-Large
 12-02100-01 1 Handle, Medium
 12-01310-90 1 Blade Macintosh Fig.2
 12-01310-10 1 Blade Macintosh Fig.3
 12-01310-13 1 Blade Macintosh Fig.4
 12-01310-15 1 Blade Macintosh Fig.5
- 12-04310-07** Complete set with 2 blades consisting
 12-04002-00 Plastic hard case, Large
 12-02100-01 1 Handle, Medium
 12-01310-10 1 Blade Macintosh Fig.3
 12-01310-13 1 Blade Macintosh Fig.4
- 12-04310-08** Complete set with 3 blades consisting
 12-04003-00 Plastic hard case, X-Large
 12-02100-01 1 Handle, Medium
 12-01310-10 1 Blade Macintosh Fig.3
 12-01310-13 1 Blade Macintosh Fig.4
 12-01310-15 1 Blade Macintosh Fig.5



ANESTHESIA



Macintosh Laryngoscope sets (Integrated Flexible Tip) Fiber Optic

12-04410-41 Complete set with 1 blade consisting
12-04002-00 Plastic hard case, Large
12-02200-01 1 Handle, Medium
12-01410-90 1 Blade Macintosh Fig.2 (9Drim)

12-04410-02 Complete set with 1 blade consisting
12-04002-00 Plastic hard case, Large
12-02200-01 1 Handle, Medium
12-01410-10 1 Blade Macintosh Fig.3

12-04410-03 Complete set with 1 blade consisting
12-04002-00 Plastic hard case, Large
12-02200-01 1 Handle, Medium
12-01410-13 1 Blade Macintosh Fig.4

12-04410-04 Complete set with 1 blade consisting
12-04002-00 Plastic hard case, Large
12-02200-01 1 Handle, Medium
12-01410-15 1 Blade Macintosh Fig.5

Macintosh Laryngoscope sets (Integrated Flexible Tip) Fiber Optic

12-04410-05 Complete set with 3 blades consisting
12-04003-00 Plastic hard case, X-Large
12-02200-01 1 Handle, Medium
12-01410-90 1 Blade Macintosh Fig.2
12-01410-10 1 Blade Macintosh Fig.3

12-04410-06 Complete set with 4 blades consisting
12-04003-00 Plastic hard case, X-Large
12-02200-01 1 Handle, Medium
12-01410-90 1 Blade Macintosh Fig.2
12-01410-10 1 Blade Macintosh Fig.3
12-01410-13 1 Blade Macintosh Fig.4
12-01410-15 1 Blade Macintosh Fig.5

12-04410-07 Complete set with 2 blades consisting
12-04002-00 Plastic hard case, Large
12-02200-01 1 Handle, Medium
12-01410-10 1 Blade Macintosh Fig.3
12-01410-13 1 Blade Macintosh Fig.4

12-04410-08 Complete set with 3 blades consisting
12-04003-00 Plastic hard case, X-Large
12-02200-01 1 Handle, Medium
12-01410-10 1 Blade Macintosh Fig.3
12-01410-13 1 Blade Macintosh Fig.4
12-01410-15 1 Blade Macintosh Fig.5

ANESTHESIA



**Macintosh Laryngoscope sets
(Cold Light Guide Interchangeable)
Fiber Optic**

- 12-04510-01** Complete set with 3 blades consisting
 12-04001-00 Plastic hard case, Small
 12-02200-01 1 Handle, Medium
 12-01510-70 1 Blade Macintosh Fig.1
 12-01510-78 1 Blade Macintosh Fig.2 (78mm)
 12-01510-10 1 Blade Macintosh Fig.3

- 12-04510-02** Complete set with 3 blades consisting
 12-04001-00 Plastic hard case, Small
 12-02200-01 1 Handle, Medium
 12-01510-70 1 Blade Macintosh Fig.1
 12-01510-90 1 Blade Macintosh Fig.2 (90mm)
 12-01510-10 1 Blade Macintosh Fig.3

- 12-04510-03** Complete set with 3 blades consisting
 12-04001-00 Plastic hard case, Small
 12-02200-01 1 Handle, Medium
 12-01510-78 1 Blade Macintosh Fig.2 (78mm)
 12-01510-10 1 Blade Macintosh Fig.3
 12-01510-13 1 Blade Macintosh Fig.4

- 12-04510-04** Complete set with 3 blades consisting
 12-04001-00 Plastic hard case, Small
 12-02200-01 1 Handle, Medium
 12-01510-90 1 Blade Macintosh Fig.2 (90mm)
 12-01510-10 1 Blade Macintosh Fig.3
 12-01510-13 1 Blade Macintosh Fig.4

**Macintosh Laryngoscope sets
(Cold Light Guide Interchangeable)
Fiber Optic**

- 12-05510-01** Complete set with 3 blades consisting
 12-05004-00 Soft pouch with 4 Pockets
 12-02200-01 1 Handle, Medium
 12-01510-70 1 Blade Macintosh Fig.1
 12-01510-78 1 Blade Macintosh Fig.2 (78mm)
 12-01510-10 1 Blade Macintosh Fig.3

- 12-05510-02** Complete set with 3 blades consisting
 12-05004-00 Soft pouch with 4 Pockets
 12-02200-01 1 Handle, Medium
 12-01510-70 1 Blade Macintosh Fig.1
 12-01510-90 1 Blade Macintosh Fig.2 (90mm)
 12-01510-10 1 Blade Macintosh Fig.3

- 12-05510-03** Complete set with 3 blades consisting
 12-05004-00 Soft pouch with 4 Pockets
 12-02200-01 1 Handle, Medium
 12-01510-78 1 Blade Macintosh Fig.2 (78mm)
 12-01510-10 1 Blade Macintosh Fig.3
 12-01510-13 1 Blade Macintosh Fig.4

- 12-05510-04** Complete set with 3 blades consisting
 12-05004-00 Soft pouch with 4 Pockets
 12-02200-01 1 Handle, Medium
 12-01510-90 1 Blade Macintosh Fig.2 (90mm)
 12-01510-10 1 Blade Macintosh Fig.3
 12-01510-13 1 Blade Macintosh Fig.4



ANESTHESIA



Macintosh Laryngoscope sets
(Cold Light Guide Interchangeable)
Fiber Optic

- 12-04510-05** Complete set with 4 blades consisting
12-04002-00 Plastic hard case, Large
12-02200-01 1 Handle, Medium
12-01510-70 1 Blade Macintosh Fig.1
12-01510-78 1 Blade Macintosh Fig.2 (78mm)
12-01510-10 1 Blade Macintosh Fig.3
12-01510-13 1 Blade Macintosh Fig.4

- 12-04510-06** Complete set with 4 blades consisting
12-04002-00 Plastic hard case, Large
12-02200-01 1 Handle, Medium
12-01510-70 1 Blade Macintosh Fig.1
12-01510-90 1 Blade Macintosh Fig.2 (90mm)
12-01510-10 1 Blade Macintosh Fig.3
12-01510-13 1 Blade Macintosh Fig.4

- 12-04510-07** Complete set with 5 blades consisting
12-04001-00 Plastic hard case, Large
12-02200-01 1 Handle, Medium
12-01510-55 1 Blade Macintosh Fig.0
12-01510-70 1 Blade Macintosh Fig.1
12-01510-78 1 Blade Macintosh Fig.2 (78mm)
12-01510-10 1 Blade Macintosh Fig.3
12-01510-13 1 Blade Macintosh Fig.4

- 12-04510-08** Complete set with 5 blades consisting
12-04002-00 Plastic hard case, Large
12-02200-01 1 Handle, Medium
12-01510-55 1 Blade Macintosh Fig.0
12-01510-70 1 Blade Macintosh Fig.1
12-01510-90 1 Blade Macintosh Fig.2 (90mm)
12-01510-10 1 Blade Macintosh Fig.3
12-01510-13 1 Blade Macintosh Fig.4



Macintosh Laryngoscope sets
(Cold Light Guide Interchangeable)
Fiber Optic

- 12-05510-05** Complete set with 4 blades consisting
12-05005-00 Soft pouch with 5 Pockets
12-02200-01 1 Handle, Medium
12-01510-70 1 Blade Macintosh Fig.1
12-01510-78 1 Blade Macintosh Fig.2 (78mm)
12-01510-10 1 Blade Macintosh Fig.3
12-01510-13 1 Blade Macintosh Fig.4

- 12-05510-06** Complete set with 4 blades consisting
12-05005-00 Soft pouch with 5 Pockets
12-02200-01 1 Handle, Medium
12-01510-70 1 Blade Macintosh Fig.1
12-01510-90 1 Blade Macintosh Fig.2 (90mm)
12-01510-10 1 Blade Macintosh Fig.3
12-01510-13 1 Blade Macintosh Fig.4

- 12-05510-07** Complete set with 5 blades consisting
12-05006-00 Soft pouch with 6 Pockets
12-02200-01 1 Handle, Medium
12-01510-55 1 Blade Macintosh Fig.0
12-01510-70 1 Blade Macintosh Fig.1
12-01510-78 1 Blade Macintosh Fig.2 (78mm)
12-01510-10 1 Blade Macintosh Fig.3
12-01510-13 1 Blade Macintosh Fig.4

- 12-05510-08** Complete set with 5 blades consisting
12-05006-00 Soft pouch with 6 Pockets
12-02200-01 1 Handle, Medium
12-01510-55 1 Blade Macintosh Fig.0
12-01510-70 1 Blade Macintosh Fig.1
12-01510-90 1 Blade Macintosh Fig.2 (90mm)
12-01510-10 1 Blade Macintosh Fig.3
12-01510-13 1 Blade Macintosh Fig.4

ANESTHESIA



**Miller Laryngoscope sets
(Cold Light Guide Interchangeable)
Fiber Optic**

- 12-04530-01** Complete set with 5 blades consisting
 12-04002-00 Plastic hard case, Large
 12-02200-01 1 Handle, Medium
 12-01530-55 1 Blade Miller Fig.0
 12-01530-80 1 Blade Miller Fig.1
 12-01530-13 1 Blade Miller Fig.2
 12-01530-17 1 Blade Miller Fig.3
 12-01530-18 1 Blade Miller Fig.4

- 12-04530-02** Complete set with 2 blades consisting
 12-04001-00 Plastic hard case, Small
 12-02200-01 1 Handle, Medium
 12-01530-55 1 Blade Miller Fig.0
 12-01530-80 1 Blade Miller Fig.1

- 12-04530-03** Complete set with 2 blades consisting
 12-04001-00 Plastic hard case, Small
 12-02200-02 1 Handle, Small
 12-01530-45 1 Blade Miller Fig.00
 12-01530-55 1 Blade Miller Fig.0

- 12-04530-04** Complete set with 5 blades consisting
 12-04002-00 Plastic hard case, Large
 12-02200-01 1 Handle Pediatric
 12-01530-45 1 Blade Miller Fig.00
 12-01530-55 1 Blade Miller Fig.0
 12-01530-80 1 Blade Miller Fig.1
 12-01530-13 1 Blade Miller Fig.2
 12-01530-17 1 Blade Miller Fig.3

**Miller Laryngoscope sets
(Cold Light Guide Interchangeable)
Fiber Optic**

- 12-05530-01** Complete set with 5 blades consisting
 12-05006-00 Soft pouch with 6 Pockets
 12-02200-01 1 Handle, Medium
 12-01530-55 1 Blade Miller Fig.0
 12-01530-80 1 Blade Miller Fig.1
 12-01530-13 1 Blade Miller Fig.2
 12-01530-17 1 Blade Miller Fig.3
 12-01530-18 1 Blade Miller Fig.4

- 12-05530-02** Complete set with 2 blades consisting
 12-05003-00 Soft pouch with 3 Pockets
 12-02200-01 1 Handle, Medium
 12-01530-55 1 Blade Miller Fig.0
 12-01530-80 1 Blade Miller Fig.1

- 12-05530-03** Complete set with 2 blades consisting
 12-05003-00 Soft pouch with 3 Pockets
 12-02200-02 1 Handle, Small
 12-01530-45 1 Blade Miller Fig.00
 12-01530-55 1 Blade Miller Fig.0



12-04131-02
 VET. Miller Laryngoscope Conventional set of 5 blades (0,1,2,3,4) 140 Degree,



12-04131-01
 VET. Miller Laryngoscope Conventional set of 5 blades (0,1,2,3,4)

ANESTHESIA



Macintosh (Metal Disposable Laryngoscope Blades Conventional)

- 12-01616-55 1 Blade Macintosh Fig.0
- 12-01616-70 1 Blade Macintosh Fig.1
- 12-01616-90 1 Blade Macintosh Fig.2
- 12-01616-10 1 Blade Macintosh Fig.3
- 12-01616-13 1 Blade Macintosh Fig.4

Miller (Metal Disposable Laryngoscope Blades Conventional)

- 12-01636-45 1 Blade Miller Fig.00
- 12-01636-55 1 Blade Miller Fig.0
- 12-01636-80 1 Blade Miller Fig.1
- 12-01636-13 1 Blade Miller Fig.2
- 12-01636-17 1 Blade Miller Fig.3
- 12-01636-18 1 Blade Miller Fig.4

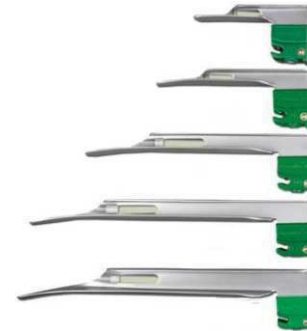

Macintosh (Metal Disposable Laryngoscope Blades Green System)

- 12-01718-55 1 Blade Macintosh Fig.0
- 12-01718-70 1 Blade Macintosh Fig.1
- 12-01718-90 1 Blade Macintosh Fig.2
- 12-01718-10 1 Blade Macintosh Fig.3
- 12-01718-12 1 Blade Macintosh Fig.3.5
- 12-01718-13 1 Blade Macintosh Fig.4

Miller (Metal Disposable Laryngoscope Blades Green System)

- 12-01738-45 1 Blade Miller Fig.00
- 12-01738-55 1 Blade Miller Fig.0
- 12-01738-80 1 Blade Miller Fig.1
- 12-01738-13 1 Blade Miller Fig.2
- 12-01738-17 1 Blade Miller Fig.3
- 12-01738-18 1 Blade Miller Fig.4



Macintosh (Plastic Disposable Laryngoscope Blades)

- 12-01748-55 1 Blade Macintosh Fig.0
- 12-01748-70 1 Blade Macintosh Fig.1
- 12-01748-90 1 Blade Macintosh Fig.2
- 12-01748-10 1 Blade Macintosh Fig.3
- 12-01748-13 1 Blade Macintosh Fig.4

Miller (Plastic Disposable Laryngoscope Blades)

- 12-01758-45 1 Blade Miller Fig.00
- 12-01758-55 1 Blade Miller Fig.0
- 12-01758-80 1 Blade Miller Fig.1
- 12-01758-13 1 Blade Miller Fig.2
- 12-01758-17 1 Blade Miller Fig.3
- 12-01758-18 1 Blade Miller Fig.4

ANESTHESIA



12-00100-15
15.0cm



12-00100-17
17.0cm



12-00100-20
20.0cm



12-00100-25
25.0cm



MAGILL

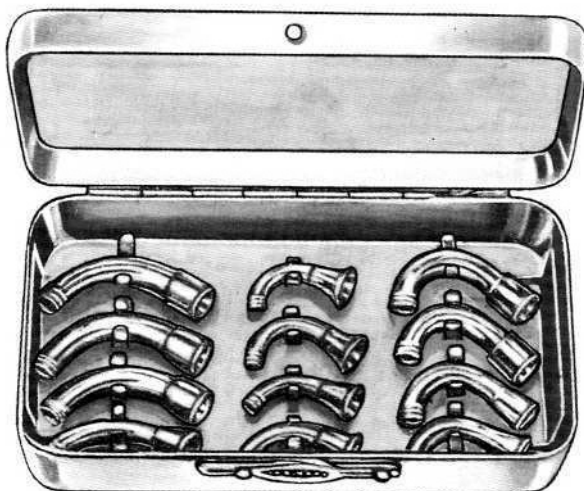

MAGILL
12-00110-00 Connection set



MAGILL (oral)
mm dia.



MAGILL (nasal)
mm dia.

12-00114-55	5.5	12-00116-55	5.5
12-00114-65	6.5	12-00116-65	6.5
12-00114-75	7.5	12-00116-75	7.5
12-00114-80	8.0	12-00116-80	8.0
12-00114-85	8.5	12-00116-85	8.5
12-00114-95	9.5	12-00116-95	9.5
12-00114-10	10.0	12-00116-10	10.0
12-00114-15	10.5	12-00116-15	10.5

Anesthesia Instruments



How To Contact Us

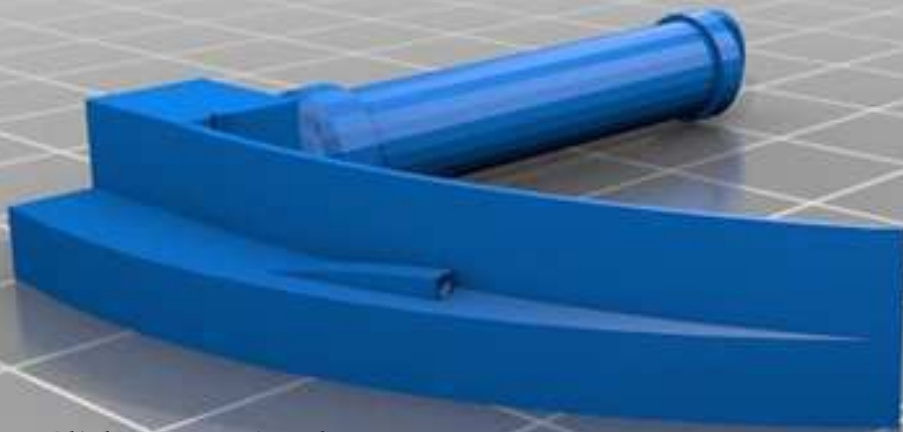
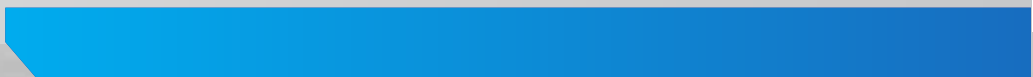

Crown Click International

Ph: +923338646869
+923367374731